

Categorical Semantics of Linear Logic

Paul-André Melliès

Proof theory is the result of a short and tumultuous history, developed on the periphery of mainstream mathematics. Hence, its language is often idiosyncratic: sequent calculus, cut-elimination, subformula property, etc. This survey is designed to guide the novice reader and the itinerant mathematician along a smooth and consistent path, investigating the symbolic mechanisms of cut-elimination, and their algebraic transcription as coherence diagrams in categories with structure. This spiritual journey at the meeting point of linguistic and algebra is demanding at times, but also pleasantly rewarding: to date, no language (either formal or informal) has been studied by mathematicians as thoroughly as the language of proofs.

We start the survey by a short introduction to proof theory (Chapter 1) followed by an informal explanation of the principles of denotational semantics (Chapter 2) which we understand as a representation theory for proofs – generating algebraic invariants modulo cut-elimination. After describing in full detail the cut-elimination procedure of linear logic (Chapter 3), we explain how to transcribe it into the language of categories with structure. We review three alternative formulations of $*$ -autonomous category, or monoidal category with classical duality (Chapter 4). Then, after giving a 2-categorical account of lax and oplax monoidal adjunctions (Chapter 5) and recalling the notions of monoids and monads (Chapter 6) we relate four different categorical axiomatizations of propositional linear logic appearing in the literature (Chapter 7). We conclude the survey by describing two concrete models of linear logic, based on coherence spaces and sequential games (Chapter 8) and by discussing a series of future research directions (Chapter 9).

Keywords: Proof theory, sequent calculus, cut-elimination, categorical semantics, linear logic, monoidal categories, $*$ -autonomous categories, linearly distributive categories, dialogue categories, string diagrams, functorial boxes, 2-categories, monoidal functors, monoidal adjunctions, coherence spaces, game semantics.

1 Proof theory: a short introduction

From vernacular proofs to formal proofs: Gottlob Frege

By nature and taste, the mathematician studies properties of specific mathematical objects, like rings, manifolds, operator algebras, etc. This practice involves a high familiarity with proofs, and with their elaboration. Hence, building a proof is frequently seen as an art, or at least as a craft, among mathematicians. Any chair is fine to sit on, but some chairs are more elegant than others. Similarly, the same theorem may be established by beautiful or by ugly means. But the experienced mathematician will always look for an elegant proof.

In his daily work, the mathematician thinks of a proof as a rational argument exchanged on a blackboard, or exposed in a book – without further inquiry. The proof is seen as a vehicle of thought, not as an object of formal investigation. In that respect, the logician interested in *proof theory* is a peculiar kind of mathematician: one who investigates *inside the language of mathematics* the linguistic event of convincing someone else, or oneself, by a mathematical argument.

Proof theory really started in 1879, when Gottlob Frege, a young lecturer at the University of Iena, published a booklet of eighty-eight pages, and one hundred thirty-three formulas [33]. In this short monograph, Frege introduced the first mathematical notation for proofs, which he called *Begriffsschrift* in German – a neologism translated today as *ideography* or *concept script*. In his introduction, Frege compares this ideography to a microscope which translates *vernacular proofs* exchanged between mathematicians into *formal proofs* which may be studied like any other mathematical object.

In this formal language invented by Frege, proofs are written in two stages. First, a formula is represented as 2-dimensional graphical structures: for instance, the syntactic tree

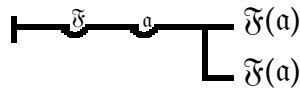

is a graphical notation for the formula written

$$\forall x. \forall a. x(a) \Rightarrow x(a)$$

in our contemporary notation – where the first-order variable a and the second-order variable x are quantified universally. Then, a proof is represented as a sequence of such formulas, constructed incrementally according to a series of *derivation rules*, or logical principles. It is remarkable that Frege introduced this language of proofs, and formulated in it the first theory of quantification.

Looking for Foundations: David Hilbert

Despite his extraordinary insight and formal creativity, Gottlob Frege remained largely unnoticed by the mathematical community of his time. Much to Frege's sorrow, most of his articles were rejected by mainstream mathematical journals. In fact, the few contemporary logicians who read the ideography generally

confused his work with George Boole's algebraic account of logic. In a typical review, a prominent German logician of the time describes the 2-dimensional notation as "a monstrous waste of space" which "indulges in the Japanese custom of writing vertically". Confronted to negative reactions of that kind, Frege generally ended up rewriting his mathematical articles in a condensed and non technical form, for publication in local philosophical journals.

Fortunately, the ideography was saved from oblivion at the turn of the century, thanks to Bertrand Russell – whose curiosity in Frege's work was initially aroused by a review by Giuseppe Peano, written in Italian [76]. At about the same time, David Hilbert, who was already famous for his work in algebra, got also interested in Gottlob Frege's ideography. On that point, it is significant that David Hilbert raised a purely proof-theoretic problem in his famous communication of twenty-three open problems at the International Congress of Mathematicians in Paris, exposed as early as 1900. The second problem of the list consists indeed of showing that arithmetic is consistent, that is, without contradiction.

David Hilbert further develops this idea in his monograph on the Infinite, written 25 years later [46]. He explains there that he hopes to establish, by purely *finite* combinatorial arguments on formal proofs, that there exists no contradiction in mathematics — in particular no contradiction in arguments involving *infinite* objects in arithmetic and analysis. This finitist program was certainly influenced by his successful work in algebraic geometry, which is also based on the finitist principle of reducing the infinite to the finite. This idea may also have been influenced by discussions with Frege. However, Kurt Gödel established a few years later, with his incompleteness theorem (1931) that Hilbert's program was a hopeless dream: consistency of arithmetics cannot be established by purely arithmetical arguments.

Consistency of Arithmetics: Gerhard Gentzen

Hilbert's dream was fruitful nonetheless: Gerhard Gentzen (who was originally a student of Hermann Weyl) established the consistency of arithmetics in 1936, by a purely combinatorial argument on the structure of arithmetic proofs. This result seems to contradict the fact just mentioned about Gödel's incompleteness theorem, that no proof of consistency of arithmetic can be performed inside arithmetic. The point is that Gentzen used in his argument a transfinite induction up to Cantor's ordinal ε_0 – and this part of the reasoning lies outside arithmetics. Recall that the ordinal ε_0 is the first ordinal in Cantor's epsilon hierarchy: it is defined as the smallest ordinal which cannot be described starting from zero, and using addition, multiplication and exponentiation of ordinals to the base ω .

Like many mathematicians and philosophers of his time, Gerhard Gentzen was fascinated by the idea of providing safe foundations (*Grundlagen* in German) for science and knowledge. By proving consistency of arithmetic, Gentzen hoped to secure this part of mathematics from the kind of antinomies or paradoxes discovered around 1900 in Set Theory by Cesare Burali-Forti, Georg Can-

tor, and Bertrand Russell. Today, this purely foundational motivation does not seem as relevant as it was in the early 1930s. Most mathematicians believe that reasoning by finite induction on natural numbers is fine, and does not lead to contradiction in arithmetics. Besides, it seems extravagant to convince the remaining skeptics that finite induction is safe, by exhibiting Gentzen's argument based on transfinite induction...

The sequent calculus

For that reason, Gentzen's work on consistency could have been forgotten along the years, and reduced in the end to a dusty trinket displayed in a cabinet of mathematical curiosity. Quite fortunately, the contrary happened. Gentzen's work is regarded today as one of the most important and influential contributions ever made to logic and proof theory. However, this contemporary evaluation of his work requires to reverse the traditional perspective: what matters today is not the consistency result in itself, but rather the method invented by Gerhard Gentzen in order to establish this result.

This methodology is based on a formal innovation: the *sequent calculus* and a fundamental discovery: the *cut-elimination theorem*. Together, this calculus and theorem offer an elegant and flexible framework to formalize proofs — either in classical or in intuitionistic logic, as Gentzen advocates in his original work, or in more recent logical systems, unknown at the time, like linear logic. The framework improves in many ways the formal proof systems designed previously by Gottlob Frege, Bertrand Russell, and David Hilbert. Since the whole survey is based on this particular formulation of logic, we find it useful to explain below the cardinal principles underlying the sequent calculus and its cut-elimination procedure.

Formulas

For simplicity, we restrict ourselves to propositional logic without quantifiers, either on first-order entities (elements) or second-order entities (propositions or sets). Accordingly, we do not consider first-order variables. The resulting logic is very elementary: every formula A is simply defined as a binary rooted tree

- with nodes labeled by a conjunction (noted \wedge), a disjunction (noted \vee), or an implication (noted \Rightarrow),
- with leaves labeled by the constant true (noted *True*), the constant false (noted *False*) or a propositional variable (ranging over A , B or C).

A typical formula is the so-called Peirce's law:

$$((A \Rightarrow B) \Rightarrow A) \Rightarrow A$$

which cannot be proved in intuitionistic logic, but can be proved in classical logic, as we shall see later in this introductory chapter.

Sequents

A *sequent* is defined as a pair of sequences of formulas A_1, \dots, A_m and B_1, \dots, B_n separated by a symbol \vdash in the following way:

$$A_1, \dots, A_m \vdash B_1, \dots, B_n. \quad (1)$$

The sequent (1) should be understood informally as the statement that the conjunction of all the formulas A_1, \dots, A_m implies the disjunction of all the formulas B_1, \dots, B_n . This may be written alternatively as

$$A_1 \wedge \dots \wedge A_m \quad \Rightarrow \quad B_1 \vee \dots \vee B_n.$$

Three easy sequents

The simplest example of sequent is the following:

$$A \vdash A \quad (2)$$

which states that the formula A implies the formula A . Another very simple sequent is

$$A, B \vdash A \quad (3)$$

which states that the conjunction of the formulas A and B implies the formula A . Yet another typical sequent is

$$A \vdash A, B \quad (4)$$

which states that the formula A implies the disjunction of the formulas A and B .

Philosophical interlude: truth values and tautologies

The specialists in proof theory are generally reluctant to justify the definition of their sequent calculus by the external notion of “truth value” of a formula in a model. However, the notion of “truth value” has been so much emphasized by Alfred Tarski after Gottlob Frege, and it is so widespread today in the logical as well as the extra-logical circles, that the notion may serve as a useful guideline for the novice reader who meets Gerhard Gentzen’s sequent calculus for the first time. It will always be possible to explain the conceptual deficiencies of the notion later, and the necessity to reconstruct it from inside proof theory.

From this perspective, the sequent (1) states that in any model \mathcal{M} in which the formulas A_1, \dots, A_m are all true, then at least one of the formulas B_1, \dots, B_n is also true. The key point, of course, is that the sequent does not reveal which formula is satisfied among B_1, \dots, B_n . So, in some sense, truth is distributed among the formulas... this making all the spice of the sequent calculus!

One may carry on in this model-theoretic line, and observe that the three sequents (2), (3) and (4) are tautologies in the sense that they happen to be true in any model \mathcal{M} . For instance, the tautology (2) states that a formula A is true in \mathcal{M} whenever the formula A is true; and the tautology (4) states that the formula A or the formula B is true in \mathcal{M} when the formula A is true.

Proofs: deriving tautologies from tautologies

What is interesting from the proof-theoretic point of view is that tautologies may be deduced mechanically from tautologies, by applying well-chosen rules of logic. For instance, the two tautologies (3) and (4) are deduced from the tautology (2) in the following way. Suppose that one has established that a given sequent

$$\Gamma_1, \Gamma_2 \vdash \Delta$$

describes a tautology — where Γ_1 and Γ_2 and Δ denote sequences of formulas. It is not difficult to establish then that the sequent

$$\Gamma_1, B, \Gamma_2 \vdash \Delta$$

describes also a tautology. The sequent $\Gamma_1, B, \Gamma_2 \vdash \Delta$ states indeed that at least one of the formulas in Δ is true when all the formulas in Γ_1 and Γ_2 and moreover the formula B are true. But this statement follows immediately from the fact that the sequent $\Gamma_1, \Gamma_2 \vdash \Delta$ is a tautology. Similarly, we leave the reader establish that whenever a sequent

$$\Gamma \vdash \Delta_1, \Delta_2$$

is a tautology, then the sequent

$$\Gamma \vdash \Delta_1, B, \Delta_2$$

is also a tautology, for every formula B and every pair of sequences of formulas Δ_1 and Δ_2 .

The rules of logic: weakening and axiom

We have just identified two simple recipes to deduce a tautology from another tautology. These two basic rules of logic are called *Left Weakening* and *Right Weakening*. They reflect the basic principle of classical and intuitionistic logic, that a formula $A \Rightarrow B$ may be established just by proving the formula B , without using the hypothesis A . Like the other rules of logic, they are written down vertically in the sequent calculus, with the starting sequent on top, and the resulting sequent at bottom, separated by a line, in the following way:

$$\frac{\Gamma_1, \Gamma_2 \vdash \Delta}{\Gamma_1, B, \Gamma_2 \vdash \Delta} \text{ Left Weakening} \quad (5)$$

and

$$\frac{\Gamma \vdash \Delta_1, \Delta_2}{\Gamma \vdash \Delta_1, B, \Delta_2} \text{ Right Weakening} \quad (6)$$

Gerhard Gentzen's sequent calculus is based on the principle that a *proof* describes a series of rules of logic like (5) and (6) applied to an elementary tautology like (2). For homogeneity and conceptual clarity, the sequent (2) itself is identified as the result of a specific logical rule, called the *Axiom*, which deduces the sequent (2) from no sequent at all. The rule is thus written as follows:

$$\frac{}{A \vdash A} \text{Axiom}$$

The sequent calculus takes advantage of the horizontal notation for sequents, and of the vertical notation for rules, to write down proofs as 2-dimensional entities. For instance, the informal proof of sequent (3) is written as follows in the sequent calculus:

$$\frac{\frac{}{A \vdash A} \text{Axiom}}{A, B \vdash A} \text{Left Weakening} \quad (7)$$

The rules of logic: contraction and exchange

Another fundamental principle of classical and intuitionistic logic is that the formula $A \Rightarrow B$ is proved when the formula B is deduced from the hypothesis formula A , possibly used *several times*. This possibility of repeating an hypothesis during an argument is reflected in the sequent calculus by two additional rules of logic, called *Left Contraction* and *Right Contraction*, formulated as follows:

$$\frac{\Gamma_1, A, A, \Gamma_2 \vdash \Delta}{\Gamma_1, A, \Gamma_2 \vdash \Delta} \text{Left Contraction} \quad (8)$$

and

$$\frac{\Gamma \vdash \Delta_1, A, A, \Delta_2}{\Gamma \vdash \Delta_1, A, \Delta_2} \text{Right Contraction} \quad (9)$$

Another basic principle of classical and intuitionistic logic is that the order of hypothesis and conclusions does not really matter in a proof. This principle is reflected in the sequent calculus by the *Left Exchange* and *Right Exchange* rules:

$$\frac{\Gamma_1, A, B, \Gamma_2 \vdash \Delta}{\Gamma_1, B, A, \Gamma_2 \vdash \Delta} \text{Left Exchange}$$

and

$$\frac{\Gamma \vdash \Delta_1, A, B, \Delta_2}{\Gamma \vdash \Delta_1, B, A, \Delta_2} \text{Right Exchange}$$

The rules of logic: logical rules vs. structural rules

According to Gentzen, the rules of logic should be separated into three classes:

- the axiom rule,
- the logical rules,
- the structural rules: weakening, contraction, exchange, and cut.

We have already encountered the axiom rule, as well as all the structural rules, except for the cut rule. This rule deserves a special discussion, and will be introduced later for that reason. There remains the logical rules, which differ in nature from the structural rules. The structural rules manipulate the formulas of the sequent, but do not alter them. In contrast, the task of each logical rule is to introduce a new logical connective in a formula, either on the left-hand side

or right-hand side of the sequent. Consequently, there exist two kinds of logical rules (left and right introduction) for each connective of the logic. As a matter of illustration, the left and right introduction rules associated with conjunction are:

$$\frac{\Gamma, A, B \vdash \Delta}{\Gamma, A \wedge B \vdash \Delta} \text{ Left } \wedge$$

and

$$\frac{\Gamma_1 \vdash A, \Delta_1 \quad \Gamma_2 \vdash B, \Delta_2}{\Gamma_1, \Gamma_2 \vdash A \wedge B, \Delta_1, \Delta_2} \text{ Right } \wedge$$

The left and right introduction rules associated with disjunction are:

$$\frac{\Gamma_1, A \vdash \Delta_1 \quad \Gamma_2, B \vdash \Delta_2}{\Gamma_1, \Gamma_2, A \vee B \vdash \Delta_1, \Delta_2} \text{ Left } \vee$$

and

$$\frac{\Gamma \vdash A, B, \Delta}{\Gamma \vdash \Delta_1, A \vee B, \Delta_2} \text{ Right } \vee$$

The left and right introduction rules associated with the constant *True* are:

$$\frac{\Gamma_1, \Gamma_2 \vdash \Delta}{\Gamma_1, \text{True}, \Gamma_2 \vdash \Delta} \text{ Left } \text{True}$$

and

$$\frac{}{\vdash \text{True}} \text{ Right } \text{True}$$

The left and right introduction rules associated with the constant *False* are:

$$\frac{}{\text{False} \vdash} \text{ Left } \text{False}$$

and

$$\frac{\Gamma \vdash \Delta_1, \Delta_2}{\Gamma \vdash \Delta_1, \text{False}, \Delta_2} \text{ Right } \text{False}$$

The introduction rules for the constants *True* and *False* should be understood as nullary versions of the introduction rules for the binary connectives \wedge and \vee respectively.

The left and right introduction rules associated with implication are:

$$\frac{\Gamma_1 \vdash A, \Delta_1 \quad \Gamma_2, B \vdash \Delta_2}{\Gamma_1, \Gamma_2, A \Rightarrow B \vdash \Delta_1, \Delta_2} \text{ Left } \Rightarrow$$

and

$$\frac{\Gamma, A \vdash B, \Delta}{\Gamma \vdash A \Rightarrow B, \Delta} \text{ Right } \Rightarrow$$

It may be worth mentioning that in each of the introduction rules above, the formulas A and B as well as the sequences of formulas Γ , Γ_1 , Γ_2 and Δ , Δ_1 , Δ_2 are arbitrary.

Formal proofs as derivation trees

At this point, we have already constructed a few formal proofs in our sequent calculus for classical logic, and it may be the proper stage to give a general definition. From now on, a *formal proof* is defined as a derivation tree constructed according to the rules of the sequent calculus. By *derivation tree*, we mean a rooted tree in which:

- every leaf is labeled by an axiom rule,
- every node is labeled by a rule of the sequent calculus,
- every edge is labeled by a sequent.

A derivation tree should satisfy the expected consistency properties relating the sequents on the edges to the rules on the nodes. In particular, the arity of a node in the derivation tree follows from the number of sequents on top of the rule: typically, a node labeled with the *Left* \wedge rule has arity one, whereas a node labeled with the *Right* \wedge rule has arity two. Note that every derivation tree has a root, which is a node labeled by a rule of the sequent calculus. As expected, the *conclusion* of the proof is defined as the sequent $\Gamma \vdash \Delta$ obtained by that last rule.

Philosophical interlude: the anti-realist tradition in proof theory

As soon as the sequent calculus is properly understood by the novice reader, the specialist in proof theory will generally advise this reader to forget any guideline related to model theory, like truth-values or tautologies. Apparently, this dogma of proof theory follows from a naive application of Ockham's razor: now that proofs can be produced mechanically by a symbolic device (the sequent calculus) independently of any notion of truth... why should we remember any of the "ancient" model-theoretic explanations?

In fact, the philosophical position generally adopted in proof theory since Gentzen (at least) is far more radical – even if this remains usually implicit in daily mathematical work. This position may be called *anti-realist* to stress the antagonism with the *realist* position. We will only sketch the debate in a few words here. For the realist, the world is constituted of a fixed set of objects, independent of the mind and of its symbolic representations. Thus, the concept of "truth" amounts to a proper correspondence between the words and symbols emanating from the mind, and the objects and external things of the world. For the anti-realist, on the contrary, the very question "what objects is the world made of?" requires already a theory or a description. In that case, the concept of "truth" amounts rather to some kind of ideal coherence between our various beliefs and experiences. The anti-realist position in proof theory may be summarized in four technical aphorisms:

- The sequent calculus generates formal proofs, and these formal proofs should be studied as autonomous entities, just like any other mathematical object.
- The notion of “logical truth” in model-theory is based on the realist idea of the existence of an external world: the model. Unfortunately, this intuition of an external world is too redundant to be useful: what information is provided by the statement that “the formula $A \wedge B$ is true if and only if the formula A is true and the formula B is true” ?
- So, the “meaning” of the connectives of logic arises from their introduction rules in the sequent calculus, and not from an external and realist concept of truth-value. These introduction rules are inherently justified by the structural properties of proofs, like cut-elimination, or the subformula property.
- Gödel’s completeness theorem may be re-understood in this purely proof-theoretic way: every model \mathcal{M} plays the role of a potential refutator, simulated by some kind of infinite non recursive proof — this leading to a purely proof-theoretic exposition of the completeness theorem.

This position is already apparent in Gerhard Gentzen’s writings [36]. It is nicely advocated today by Jean-Yves Girard [41, 42]. This line of thought conveys the seeds of a luminous synthesis between proof theory and model theory. There is little doubt (to the author at least) that along with game semantics and linear logic, the realizability techniques developed by Jean-Louis Krivine (see [61] in this volume) will play a key part in this highly desired unification. On the other hand, much remains to be understood on the model-theoretic and proof-theoretic sides in order to recast in proof theory the vast amount of knowledge accumulated in a century of model theory, see [80] for a nice introduction to the topic. The interested reader will find in [88] a penetrating point of view by Jean van Heijenoort on the historical origins of the dispute between model theory and proof theory.

Two exemplary proofs in classical logic

A famous principle in classical logic declares that the disjunction of a formula A and of its negation $\neg A$ is necessarily true. This principle, called the Tertium Non Datur in Latin (“the third is not given”) is nicely formulated by the formula

$$(A \Rightarrow B) \vee A$$

which states that for every formula B , either the formula A holds, or the formula A implies the formula B . This very formula is established by the following

derivation tree in our sequent calculus for classical logic:

$$\frac{\frac{\frac{\overline{A \vdash A}}{\text{Axiom}}}{\text{Right Weakening}}}{\frac{A \vdash B, A}{\text{Right } \Rightarrow}}}{\frac{\vdash A \Rightarrow B, A}{\text{Right } \vee}}}{\vdash (A \Rightarrow B) \vee A} \quad (10)$$

The proof works for every formula B , and may be specialized to the formula *False* expressing falsity. From this follows a proof of the formula:

$$\neg A \vee A$$

where we identify the negation $\neg A$ of the formula A to the formula $A \Rightarrow F$ which states that the formula A implies falsity.

We have mentioned above that Peirce's formula:

$$((A \Rightarrow B) \Rightarrow A) \Rightarrow A$$

may be established in classical logic. Indeed, we write below the shortest possible proof of the formula in our sequent calculus:

$$\frac{\frac{\frac{\overline{A \vdash A}}{\text{Axiom}}}{\text{Right Weakening}}}{\frac{A \vdash B, A}{\text{Right } \Rightarrow}}}{\frac{\vdash A \Rightarrow B, A}{\text{Right } \Rightarrow}}}{\frac{\frac{\overline{A \vdash A}}{\text{Axiom}}}{\text{Left } \Rightarrow}}}{\frac{(A \Rightarrow B) \Rightarrow A \vdash A, A}{\text{Right Contraction}}}{\frac{(A \Rightarrow B) \Rightarrow A \vdash A}{\text{Right } \Rightarrow}}}{\vdash ((A \Rightarrow B) \Rightarrow A) \Rightarrow A}$$

Note that the main part of the proof of the Tertium Non Datur appears at the very top left of that proof. In fact, it is possible to prove that the two formulas are equivalent in intuitionistic logic: in particular, each of the two formulas may be taken as an additional axiom of intuitionistic logic, in order to define classical logic.

Cut-elimination

At this point, all the rules of our sequent calculus for classical logic have been introduced... except perhaps the most fundamental one: the *cut rule*, formulated as follows:

$$\frac{\Gamma_1 \vdash A, \Delta_1 \quad A, \Gamma_2 \vdash \Delta_2}{\Gamma_1, \Gamma_2 \vdash \Delta_1, \Delta_2} \text{Cut}$$

The cut rule reflects the most famous deduction principle of logic: Modus Ponens (“affirmative mode” in Latin), a principle which states that the formula B may be deduced from the two formulas A and $A \Rightarrow B$ taken together. Indeed, suppose given two proofs π_1 and π_2 of the sequents $\vdash A$ and $A \vdash B$:

$$\frac{\begin{array}{c} \pi_1 \\ \vdots \end{array}}{\vdash A} \qquad \frac{\begin{array}{c} \pi_2 \\ \vdots \end{array}}{A \vdash B}$$

The cut rule applied to the two derivation trees leads to a proof

$$\frac{\begin{array}{c} \pi_3 \\ \vdots \end{array}}{\vdash B} = \frac{\frac{\begin{array}{c} \pi_1 \\ \vdots \end{array}}{\vdash A} \quad \frac{\begin{array}{c} \pi_2 \\ \vdots \end{array}}{A \vdash B}}{\vdash B} \text{Cut} \tag{11}$$

of the sequent $\vdash B$. This is Modus Ponens translated in the sequent calculus.

Despite the fact that it reflects Modus Ponens, a most fundamental principle of logic, Gentzen made the extraordinary observation that the cut rule may be forgotten from the point of view of provability... or what formulas can be proved in logic!

In technical terms, one says that the cut rule is *admissible* in classical logic, as well as in intuitionistic logic. This means that every sequent $\Gamma \vdash \Delta$ which may be proved by a proof π may be also proved by a proof π' in which the cut rule does not appear at any stage of the proof. Such a proof is called a *cut-free* proof. Gerhard Gentzen called this property the *cut-elimination theorem*, or *Hauptsatz* in German. Applied to our previous example (11) the property states that there exists an alternative cut-free proof

$$\frac{\begin{array}{c} \pi_4 \\ \vdots \end{array}}{\vdash B} \tag{12}$$

of the sequent $\vdash B$. The difficulty, of course, is to deduce the cut-free proof π_4 from the original proof π_3 .

The subformula property and the consistency of logic

The cut-elimination theorem is the backbone of modern proof theory. Its central position is nicely illustrated by the fact that three fundamental properties of formal logic follow quite directly from this single theorem:

- the subformula property,
- the consistency of the logic,
- the completeness theorem.

Let us discuss the subformula property first. A formula D is called a subformula of a formula AcB in three cases only:

- when the formula D is equal to the formula AcB ,
- when the formula D is subformula of the formula A ,

- when the formula D is subformula of the formula B ,

where $A \text{c} B$ means either $A \Rightarrow B$, or $A \wedge B$ or $A \vee B$. Besides, the constant formula *False* (resp. *True*) is the only subformula of the formula *False* (resp. *True*).

The subformula property states that every provable formula A may be established by a proof π in which only subformulas of the formula A appear. This unexpected property follows immediately from the cut-elimination theorem. Suppose indeed that a formula A is provable in the logic. This means that there exists a proof of the sequent $\vdash A$. By cut-elimination, there exists a cut-free proof π of the sequent $\vdash A$. A simple inspection of the rules of our sequent calculus shows that this cut-free proof π contains only subformulas of the original formula A .

Similarly, the consistency of the logic follows easily from the subformula property. Suppose indeed that the constant formula *False* is provable in the logic. By the subformula property, there exists a proof π of the sequent $\vdash \textit{False}$ which contains only subformulas of the formula *False*. Since the formula *False* is the only subformula of itself, every sequent appearing in the proof π should be a sequence of *False*:

$$\textit{False}, \dots, \textit{False} \vdash \textit{False}, \dots, \textit{False}.$$

Except for the introduction rules for *False*, every logical rule appearing in the proof π introduces a connective of logic \Rightarrow or \wedge or \vee , or the constant *True*. This establishes that the proof π is made exclusively of introduction rules for *False*, of structural rules, and of axiom rules. An inspection of these rules demonstrates that every sequent in the proof π is necessarily empty on the left-hand side, and thus of the form:

$$\vdash \textit{False}, \dots, \textit{False} \tag{13}$$

for the simple reason that any such sequent is necessarily deduced from a sequent of the same shape. Now, the only leaves of a derivation tree are the Axiom rule, the right introduction rule for *True* and the left introduction rule for *False*. None of them introduces a sequent of the shape (13). This demonstrates that there exists no proof π of the formula *False* in our logic. This is precisely the statement of consistency.

The proof is easy, but somewhat tedious. However, a purely conceptual proof is also possible. Again, suppose that there exists a derivation tree

$$\frac{\begin{array}{c} \pi \\ \vdots \end{array}}{\vdash \textit{False}}$$

leading to the sequent $\vdash \textit{False}$ in the logic. We have seen earlier that the sequent $\textit{False} \vdash$ has a proof consisting of a single introduction rule. One produces a proof of the empty sequent \vdash by cutting the two proofs together:

$$\frac{\frac{\frac{\vdots}{\vdash \text{False}}}{\vdash \text{False}} \quad \frac{\text{Left } \text{False}}{\vdash \text{False}}}{\vdash} \text{Cut}$$

The cut-elimination theorem implies that the empty sequent \vdash has a cut-free proof. This statement is clearly impossible, because every rule of logic

$$\frac{\Gamma_1 \vdash \Delta_1}{\Gamma_2 \vdash \Delta_2}$$

different from the cut-rule induces a non-empty sequent $\Gamma_2 \vdash \Delta_2$. This provides another more conceptual argument for establishing consistency of the logic.

The completeness theorem is slightly more difficult to deduce from the cut-elimination theorem. The interested reader will find a detailed proof of the theorem in the first chapter of the Handbook of Proof Theory exposed by Samuel Buss [25].

The cut-elimination procedure

In order to establish the cut-elimination theorem, Gentzen introduced a series of symbolic transformations on proofs. Each of these transformations converts a proof π containing a cut rule into a proof π' with the same conclusion. In practice, the resulting proof π' will involve several cut rules induced by the original cut rule ; but the complexity of these cut rules will be strictly less than the complexity of the cut rule in the initial proof π . Consequently, the rewriting rules may be iterated until one reaches a cut-free proof. Termination of the procedure (in the case of arithmetic) is far from obvious: it is precisely to establish the termination property that Gentzen uses a transfinite induction, up to Cantor's ordinal ε_0 . This provides an effective *cut-elimination procedure* which transforms any proof of the sequent $\Gamma \vdash \Delta$ into a cut-free proof of the same sequent. The cut-elimination theorem follows immediately.

This procedural aspect of cut-elimination is the starting point of denotational semantics, whose task is precisely to provide mathematical invariants of proofs under cut-elimination. This is a difficult exercise, because the cut-elimination procedure performs a number of somewhat intricate symbolic transformations on proofs. We will see in Chapter 3 that describing in full details the cut-elimination procedure of a reasonable proof system like linear logic requires already a dozen meticulous pages.

Intuitionistic logic

Intuitionistic logic has been introduced and developed by Luitzen Egbertus Jan Brouwer at the beginning of the 20th century, in order to provide safer foundations for mathematics. Brouwer rejected the idea of formalizing mathematics, but his own student Arend Heyting committed the outrage in 1930, and produced a formal system for intuitionistic logic. The system is based on the idea that the Tertium Non Datur principle of classical logic should be rejected.

A surprising and remarkable observation of Gerhard Gentzen is that an equivalent formalization of intuitionistic logic is obtained by restricting the sequent calculus for classical logic to “intuitionistic” sequents:

$$\Gamma \vdash A$$

with exactly one formula A on the right-hand side. The reader will easily check for illustration that the proof (10) of the sequent

$$\vdash (A \Rightarrow B) \vee A$$

cannot be performed in the intuitionistic fragment of classical logic: one needs at some point to weaken on the right-hand side of the sequent in order to perform the proof.

Linear logic

Gentzen’s idea to describe intuitionistic logic by limiting classical logic to a particular class of sequents seems just too simplistic to work... but it works indeed, and deeper structural reasons must explain this unexpected success. This reflection is at the starting point of linear logic. It appears indeed that the key feature of intuitionistic sequent calculus, compared to classical sequent calculus, is that the Weakening and Contraction rules can be only applied on the left-hand side of the sequents (= the hypothesis), and not on the right-hand side (= the conclusion).

Accordingly, linear logic is based on the idea that the Weakening and Contraction rules do not apply to *any* formula, but only to a particular class of modal formulas. So, two modalities are introduced in linear logic: the modality $!$ (pronounced “of course”) and the modality $?$ (pronounced “why not”). Then, the Weakening and Contraction rules are limited to modal formulas $!A$ on the left-hand side of the sequent, and to modal formulas $?A$ on the right-hand side of the sequent. Informally speaking, the sequent

$$A, B \vdash C$$

of intuitionistic logic is then translated as the sequent

$$!A, !B \vdash C$$

of linear logic. Here, the “of course” modality on the formulas $!A$ and $!B$ indicates that the two hypothesis may be weakened and contracted at will.

First-order logic

In this short introduction to proof theory, we have chosen to limit ourselves to the propositional fragment of classical logic: no variables, no quantification. This simplifies matters, and captures the essence of Gerhard Gentzen’s ideas.

Nevertheless, we briefly indicate below the logical principles underlying first-order classical logic. This provides us with the opportunity to recall the drinker formula, which offers a nice and pedagogical illustration of the sequent calculus at work.

In order to define first-order logic, one needs:

- an infinite set \mathcal{V} of first-order variable symbols, ranging over x, y, z ,
- a set \mathcal{F} of function symbols with a specified arity, ranging over f, g ,
- a set \mathcal{R} of relation symbols with a specified arity, ranging over R, Q .

The *terms* of the logic are constructed from the function symbols and the first-order variables. Hence, any first-order variable x is a term, and $f(t_1, \dots, t_k)$ is a term if the function symbol f has arity k , and t_1, \dots, t_k are terms. In particular, any function symbol f of arity 0 is called a constant, and defines a term. The *atomic formulas* or the logic are defined as a relation symbol substituted by terms. Hence, $R(t_1, \dots, t_k)$ is an atomic formula if the relation symbol R has arity k , and t_1, \dots, t_k are terms.

The formulas of first-order logic are constructed as in the propositional case, except that:

- propositional variables A, B, C are replaced by atomic formulas $R(t_1, \dots, t_k)$,
- every node of the formula is either a propositional connective \wedge or \vee or \Rightarrow as in the propositional case, or a universal quantifier $\forall x$, or an existential quantifier $\exists x$.

So, a typical first-order formula looks like:

$$\forall y.R(f(x), y).$$

One should be aware that this formula, in which the quantifier $\forall x$ binds the first-order variable x , is identified to the formula:

$$\forall z.R(f(x), z).$$

We will not discuss here the usual distinction between a *free* and a *bound* occurrence of a variable in a first-order formula; nor describe how a free variable x of a first-order formula $A(x)$ is substituted without capture of variable by a term t , in order to define a formula $A(t)$. These definitions will be readily found in the reader's favorite textbook on first-order logic. It should be enough to illustrate the definition by mentioning that the formula

$$A(x) = \forall y.R(f(x), y)$$

in which the term $t = g(y)$ is substituted for the variable x defines the formula

$$A(t) = \forall z.R(f(g(y)), z).$$

Except for those syntactic details, the sequent calculus works just as in the propositional case. The left introduction of the universal quantifier

$$\frac{\Gamma, A(t) \vdash \Delta}{\Gamma, \forall x.A(x) \vdash \Delta} \text{ Left } \forall$$

and the right introduction of the existential quantifier

$$\frac{\Gamma \vdash A(t), \Delta}{\Gamma \vdash \exists x.A(x), \Delta} \text{ Right } \exists$$

may be performed for any term t of the language without any restriction. On the other hand, the right introduction of the universal quantifier

$$\frac{\Gamma \vdash A(x), \Delta}{\Gamma \vdash \forall x.A(x), \Delta} \text{ Right } \forall$$

and the left introduction of the existential quantifier

$$\frac{\Gamma, A(x) \vdash \Delta}{\Gamma, \exists x.A(x) \vdash \Delta} \text{ Left } \exists$$

may be applied only if the first-order variable x does not appear in any formula of the contexts Γ and Δ . Note that the formula $A(x)$ may contain other free variables than x .

The drinker formula

Let us illustrate these rules with the first-order formula below, called the drinker formula:

$$\exists y. \{ A(y) \Rightarrow \forall x.A(x) \}. \quad (14)$$

This states that for every formula $A(x)$ with first-order variable x , there exists an element y of the ontology such that if $A(y)$ holds, then $A(x)$ holds for every element x of the ontology. The element y is thus the witness for the universal validity of $A(x)$. Although this may seem counter-intuitive, the formula is perfectly valid in classical logic.

The name of “drinker formula” comes from an entertaining illustration of the principle: suppose that x ranges over the customers of a pub, and that $A(x)$ means that the customer x drinks; then, the formula (14) states that there exists a particularly sober customer y (the drinker) such that, if this particular customer y drinks, then everybody drinks. The existence of such a customer y in the pub is far from obvious, but it may be established by purely logical means in classical logic!

Let us explain how. The drinker formula has been thoroughly analyzed by Jean-Louis Krivine who likes to replace it with a formula expressed only with universal quantification, and equivalent in classical logic:

$$\forall y. \{ (A(y) \Rightarrow \forall x.A(x)) \Rightarrow B \} \Rightarrow B.$$

Here, B stands for any formula of the logic. The original formulation (14) of the drinker formula is then obtained by replacing the formula B by the formula *False* expressing falsity, and by applying the series of equivalences in classical logic:

$$\begin{aligned}
& \neg \forall y. \{ \neg(A(y) \Rightarrow \forall x.A(x)) \} \\
\equiv & \exists y. \{ \neg \neg(A(y) \Rightarrow \forall x.A(x)) \} \\
\equiv & \exists y. \{ A(y) \Rightarrow \forall x.A(x) \}
\end{aligned}$$

where, again, we write $\neg A$ for the formula $(A \Rightarrow \text{False})$. The shortest proof of the drinker formula in classical logic is provided by the derivation tree below:

$$\begin{array}{c}
\frac{}{A(x_0) \vdash A(x_0)} \text{Axiom} \\
\frac{A(x_0) \vdash \forall x.A(x), A(x_0)}{A(x_0) \vdash \forall x.A(x), A(x_0)} \text{Right Weakening} \\
\frac{\vdash A(x_0) \Rightarrow \forall x.A(x), A(x_0)}{\vdash A(x_0) \Rightarrow \forall x.A(x), A(x_0)} \text{Right } \Rightarrow \\
\frac{\frac{}{B \vdash B} \text{Axiom}}{\vdash A(x_0) \Rightarrow \forall x.A(x) \Rightarrow B \vdash A(x_0), B} \text{Left } \Rightarrow \\
\frac{\frac{\vdash A(x_0) \Rightarrow \forall x.A(x) \Rightarrow B \vdash A(x_0), B}{\forall y. \{ (A(y) \Rightarrow \forall x.A(x)) \Rightarrow B \} \vdash A(x_0), B} \text{Left } \forall (***)}{\forall y. \{ (A(y) \Rightarrow \forall x.A(x)) \Rightarrow B \} \vdash \forall x.A(x), B} \text{Right } \forall (***) \\
\frac{\forall y. \{ (A(y) \Rightarrow \forall x.A(x)) \Rightarrow B \} \vdash \forall x.A(x), B}{\forall y. \{ (A(y) \Rightarrow \forall x.A(x)) \Rightarrow B \}, A(y_0) \vdash \forall x.A(x), B} \text{Left Weakening} \\
\frac{\forall y. \{ (A(y) \Rightarrow \forall x.A(x)) \Rightarrow B \}, A(y_0) \vdash \forall x.A(x), B}{\forall y. \{ (A(y) \Rightarrow \forall x.A(x)) \Rightarrow B \} \vdash A(y_0) \Rightarrow \forall x.A(x), B} \text{Right } \Rightarrow \\
\frac{\frac{}{B \vdash B} \text{Axiom}}{\forall y. \{ (A(y) \Rightarrow \forall x.A(x)) \Rightarrow B \} \vdash A(y_0) \Rightarrow \forall x.A(x), B} \text{Left } \Rightarrow \\
\frac{\forall y. \{ (A(y) \Rightarrow \forall x.A(x)) \Rightarrow B \}, (A(y_0) \Rightarrow \forall x.A(x)) \Rightarrow B \vdash B, B}{\forall y. \{ (A(y) \Rightarrow \forall x.A(x)) \Rightarrow B \}, \forall y. \{ (A(y) \Rightarrow \forall x.A(x)) \Rightarrow B \} \vdash B, B} \text{Left } \forall (*) \\
\frac{\forall y. \{ (A(y) \Rightarrow \forall x.A(x)) \Rightarrow B \} \vdash B, B}{\forall y. \{ (A(y) \Rightarrow \forall x.A(x)) \Rightarrow B \} \vdash B, B} \text{Contraction} \\
\frac{\forall y. \{ (A(y) \Rightarrow \forall x.A(x)) \Rightarrow B \} \vdash B, B}{\forall y. \{ (A(y) \Rightarrow \forall x.A(x)) \Rightarrow B \} \vdash B} \text{Contraction} \\
\frac{\forall y. \{ (A(y) \Rightarrow \forall x.A(x)) \Rightarrow B \} \vdash B}{\vdash \forall y. \{ (A(y) \Rightarrow \forall x.A(x)) \Rightarrow B \} \Rightarrow B} \text{Right } \Rightarrow
\end{array} \tag{15}$$

The logical argument is somewhat obscured by its formulation as a derivation tree in the sequent calculus. Its content becomes much clearer once the proof is interpreted using game semantics as a strategy implemented by the prover (Proponent) in order to convince his refutator (Opponent). The strategy works as follows. Proponent starts the interaction by suggesting a witness y_0 to the refutator. This step is performed by the Left \forall introduction (*). The selected witness y_0 may drink or not: nobody really cares at this stage, since the refutator reacts in any case, by providing his own witness x_0 . This second step is performed by the Right \forall introduction (* *). Obviously, Opponent selects the witness x_0 in order to refute the witness y_0 selected by Proponent. So, the difficulty for Proponent arises when Opponent exhibits a non-drinker x_0 whereas the witness y_0 selected by Proponent a drinker. In that case, the statement

$$A(y_0) \Rightarrow \forall x.A(x)$$

does not hold, because the weaker statement

$$A(y_0) \Rightarrow A(x_0)$$

does not hold. Very fortunately, the proof suggests a way out to Proponent in this embarrassing situation: the winning strategy for Proponent consists in replacing his original witness y_0 by the witness x_0 just selected by the Opponent. This final step is performed by the Left \forall introduction (***) of the derivation tree. Notice that, by applying this trick, Proponent is sure to defeat his refutator, because

$$A(x_0) \Rightarrow A(x_0).$$

This highly opportunistic strategy is not admitted in intuitionistic logic, because Proponent is not allowed to backtrack and to alter his original witness y_0 once he has selected it. On the other hand, the strategy is perfectly valid in classical logic. This illustrates the general principle that it is not possible to “extract” a witness y_0 from a proof π of an existential statement $\exists y.C(y)$ established in classical logic. Indeed, the proof does not necessarily “construct” a witness y_0 such that $C(y_0)$. Like the proof (15) of the drinker formula, it may defeat the refutator by taking advantage of pieces of information revealed during the interaction. The drinker formula has been the occasion of many debates around logic: the interested reader will find it discussed in a famous popular science book by Raymond Smullyan [83].

An historical remark on Gerhard Gentzen’s system **LK**

The reader familiar with proof theory will notice that our presentation of classical logic departs in several ways from Gentzen’s original presentation. One main difference is that Gentzen’s original sequent calculus **LK** contains *two* right introduction rules for disjunction:

$$\frac{\Gamma \vdash A, \Delta}{\Gamma \vdash A \vee B, \Delta} \text{ Right } \vee_1 \qquad \frac{\Gamma \vdash B, \Delta}{\Gamma \vdash A \vee B, \Delta} \text{ Right } \vee_2$$

whereas the sequent calculus presented here contains only one introduction rule:

$$\frac{\Gamma \vdash A, B, \Delta}{\Gamma \vdash \Delta_1, A \vee B, \Delta_2} \text{ Right } \vee$$

The two presentations of classical logic are very different in nature. In the terminology of linear logic, the introduction rules of the sequent calculus **LK** are called *additive* whereas the presentation chosen here is *multiplicative*. Despite the difference, it is possible to simulate the multiplicative rule inside the original system **LK**, in the following way:

$$\frac{\frac{\frac{\Gamma \vdash \Delta_1, A, B, \Delta_2}{\Gamma \vdash \Delta_1, A \vee B, B, \Delta} \text{ Right } \vee_1}{\Gamma \vdash \Delta_1, A \vee B, A \vee B, \Delta} \text{ Right } \vee_2}{\Gamma \vdash \Delta_1, A \vee B, \Delta_2} \text{ Right Contraction}$$

Conversely, the two additive introduction rules of the sequent calculus **LK** are simulated in our sequent calculus in the following way:

$$\frac{\frac{\Gamma \vdash \Delta_1, A, \Delta_2}{\Gamma \vdash \Delta_1, A, B, \Delta_2} \text{ Right Weakening}}{\Gamma \vdash \Delta_1, A \vee B, \Delta_2} \text{ Right } \vee_1 \qquad \frac{\frac{\Gamma \vdash \Delta_1, B, \Delta_2}{\Gamma \vdash \Delta_1, A, B, \Delta_2} \text{ Right Weakening}}{\Gamma \vdash \Delta_1, A \vee B, \Delta_2} \text{ Right } \vee_1$$

Note that the Weakening and the Contraction rules play a key role in the back and forth translations between the additive and the multiplicative rules for the disjunction. This illustrates and explains why the two logical systems (additive

and multiplicative) are intrinsically different, although complementary, in linear logic — since the Weakening and the Contraction rules of the logic are limited to modal formulas.

Notes and references

We advise the interested reader to look directly at the original papers by Gentzen, collected and edited by Manfred Szabo in [36]. More recent material can be found in Jean-Yves Girard's monographs [37, 38, 42] as well as in the Handbook of Proof Theory [25] edited by Samuel Buss.

2 Semantics: proof invariants and categories

2.1 Proof invariants organize themselves as categories

In order to better understand linear logic, we look for *invariants* of proofs under cut-elimination. Any such invariant is a function

$$\pi \mapsto [\pi]$$

which associates to every proof π of linear logic a mathematical entity $[\pi]$ called the *denotation* of the proof. Invariance under cut-elimination means that the denotation $[\pi]$ coincides with the denotation $[\pi']$ of any proof π' obtained by applying the cut-elimination procedure to the proof π . An analogy comes to mind with knot theory: by definition, a knot invariant is a function which associates to every knot an entity (typically, a number or a polynomial) which remains unaltered under the action of the three Reidemeister moves:

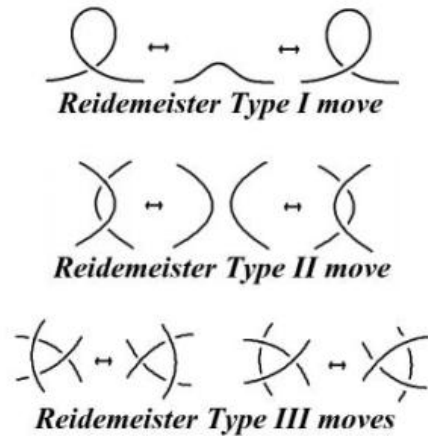

We are looking for similar invariants for proofs, this time with respect to the proof transformations occurring in the course of cut-elimination. We will see that, just like in representation theory, the construction of such knot and proof invariants is achieved by constructing suitable kinds of categories and functors.

Note that invariance is not enough: we are looking for *modular* invariants. What does that mean? Suppose given three formulas A, B, C , together with a proof π_1 of the sequent $A \vdash B$ and a proof π_2 of the sequent $B \vdash C$. We have already described the *cut-rule* in classical logic and in intuitionistic logic. The same cut-rule exists in linear logic. When applied to the proofs π_1 and π_2 , it leads to the following proof π of the sequent $A \vdash C$:

$$\frac{\frac{\pi_1}{A \vdash B} \quad \frac{\pi_2}{B \vdash C}}{A \vdash C} \text{Cut}$$

Now, we declare an invariant *modular* when the denotation of the proof π may be deduced directly from the denotations $[\pi_1]$ and $[\pi_2]$ of the proofs π_1 and π_2 . In this case, there exists a binary operation \circ on denotations satisfying

$$[\pi] = [\pi_2] \circ [\pi_1].$$

The very design of linear logic (and of its cut-elimination procedure) ensures that this composition law is associative and has a left and a right identity. What do we mean? This point deserves to be clarified. First, consider associativity. Suppose given a formula D and a proof π_3 of the sequent $C \vdash D$. By modularity, the two proofs

$$\frac{\frac{\frac{\pi_1}{\vdots}}{A \vdash B} \quad \frac{\frac{\pi_2}{\vdots}}{B \vdash C}}{A \vdash C} \text{Cut} \quad \frac{\frac{\pi_3}{\vdots}}{C \vdash D}}{A \vdash D} \text{Cut}$$

and

$$\frac{\frac{\pi_1}{\vdots}}{A \vdash B} \quad \frac{\frac{\frac{\pi_2}{\vdots}}{B \vdash C} \quad \frac{\pi_3}{\vdots}}{B \vdash D} \text{Cut}}{A \vdash D} \text{Cut}$$

have respective denotations

$$[\pi_3] \circ ([\pi_2] \circ [\pi_1]) \quad \text{and} \quad ([\pi_3] \circ [\pi_2]) \circ [\pi_1].$$

The two proofs are equivalent from the point of view of cut-elimination. Indeed, depending on the situation, the procedure may transform the first proof into the second proof, or conversely, the second proof into the first proof. This illustrates what logicians call a *commutative conversion*: in that case a conversion permuting the order of the two cut rules. By invariance, the denotations of the two proofs coincide. This establishes associativity of composition:

$$[\pi_3] \circ ([\pi_2] \circ [\pi_1]) = ([\pi_3] \circ [\pi_2]) \circ [\pi_1].$$

What about the left and right identities? There is an obvious candidate for the identity on the formula A , which is the denotation id_A associated to the proof

$$\frac{}{A \vdash A} \text{Axiom}$$

Given a proof π of the sequent $A \vdash B$, the cut-elimination procedure transforms the two proofs

$$\frac{\frac{}{A \vdash A} \text{Axiom} \quad \frac{\pi}{\vdots}}{A \vdash B} \text{Cut}$$

and

$$\frac{\frac{\pi}{\vdots} \quad \frac{A \vdash B \quad B \vdash B}{A \vdash B} \text{Axiom}}{A \vdash B} \text{Cut}$$

into the proof

$$\frac{\pi}{\vdots} \quad \frac{}{A \vdash B}$$

Modularity and invariance imply together that

$$[\pi] \circ id_A = id_B \circ [\pi] = [\pi].$$

From this, we deduce that every modular invariant of proofs gives rise to a category. In this category, every formula A defines an object $[A]$, which may rightly be called the *denotation* of the formula; and every proof

$$\frac{\pi}{\vdots} \quad \frac{}{A \vdash B}$$

denotes a morphism

$$[\pi] : [A] \longrightarrow [B]$$

which, by definition, is invariant under cut-elimination of the proof π .

2.2 A tensor product in linear logic

The usual conjunction \wedge of classical and intuitionistic logic is replaced in linear logic by a conjunction akin to the *tensor product* of linear algebra, and thus noted \otimes . We are thus tempted to look for denotations satisfying not just invariance and modularity, but also *tensoriality*. By tensoriality, we mean two related things. First, the denotation $[A \otimes B]$ of the formula $A \otimes B$ should follow directly from the denotations of the formula A and B , by applying a binary operation (also noted \otimes) on the denotations of formulas:

$$[A \otimes B] = [A] \otimes [B].$$

Second, given two proofs

$$\frac{\pi_1}{\vdots} \quad \frac{}{A_1 \vdash A_2} \quad \frac{\pi_2}{\vdots} \quad \frac{}{B_1 \vdash B_2}$$

the denotation of the proof π

$$\frac{\frac{\pi_1}{\vdots} \quad \frac{\pi_2}{\vdots}}{A_1 \vdash A_2 \quad B_1 \vdash B_2} \text{Right } \otimes$$

$$\frac{A_1, B_1 \vdash A_2 \otimes B_2}{A_1 \otimes B_1 \vdash A_2 \otimes B_2} \text{Left } \otimes$$

should follow from the denotations of the proofs π_1 and π_2 by applying a binary operation (noted \otimes again) on the denotations of proofs:

$$[\pi] = [\pi_1] \otimes [\pi_2].$$

These two requirements imply together that the linear conjunction \otimes of linear logic defines a *bifunctor* on the category of denotations. We check this claim as an exercise. Consider four proofs

$$\frac{\pi_1}{\vdots} \quad \frac{\pi_2}{\vdots} \quad \frac{\pi_3}{\vdots} \quad \frac{\pi_4}{\vdots}$$

$$\frac{}{A_1 \vdash A_2} \quad \frac{}{B_1 \vdash B_2} \quad \frac{}{A_2 \vdash A_3} \quad \frac{}{B_2 \vdash B_3}$$

with respective denotations

$$f_1 = [\pi_1], \quad f_2 = [\pi_2], \quad f_3 = [\pi_3], \quad f_4 = [\pi_4].$$

The cut-elimination procedure transforms the proof

$$\frac{\frac{\pi_1}{\vdots} \quad \frac{\pi_2}{\vdots} \quad \frac{\pi_3}{\vdots} \quad \frac{\pi_4}{\vdots}}{\frac{\frac{\frac{\frac{\frac{\frac{\pi_1}{\vdots}}{A_1 \vdash A_2} \quad \frac{\pi_2}{\vdots}}{B_1 \vdash B_2}}{A_1, B_1 \vdash A_2 \otimes B_2}}{A_1 \otimes B_1 \vdash A_2 \otimes B_2} \text{Left } \otimes \quad \frac{\frac{\frac{\frac{\pi_3}{\vdots}}{A_2 \vdash A_3} \quad \frac{\pi_4}{\vdots}}{B_2 \vdash B_3}}{A_2, B_2 \vdash A_3 \otimes B_3} \text{Right } \otimes}{A_2 \otimes B_2 \vdash A_3 \otimes B_3} \text{Left } \otimes}{A_1 \otimes B_1 \vdash A_3 \otimes B_3} \text{Cut}}$$

with denotation

$$(f_3 \otimes f_4) \circ (f_1 \otimes f_2)$$

into the proof

$$\frac{\frac{\pi_1}{\vdots} \quad \frac{\pi_3}{\vdots} \quad \frac{\pi_2}{\vdots} \quad \frac{\pi_4}{\vdots}}{\frac{\frac{\frac{\frac{\frac{\pi_1}{\vdots}}{A_1 \vdash A_2} \quad \frac{\pi_3}{\vdots}}{A_2 \vdash A_3}}{A_1 \vdash A_3} \text{Cut} \quad \frac{\frac{\frac{\frac{\pi_2}{\vdots}}{B_1 \vdash B_2} \quad \frac{\pi_4}{\vdots}}{B_2 \vdash B_3}}{B_1 \vdash B_3} \text{Cut}}{A_1, B_1 \vdash A_3 \otimes B_3} \text{Right } \otimes}{A_1 \otimes B_1 \vdash A_3 \otimes B_3} \text{Left } \otimes}$$

with denotation

$$(f_3 \circ f_1) \otimes (f_4 \circ f_2).$$

By invariance, the equality

$$(f_3 \otimes f_4) \circ (f_1 \otimes f_2) = (f_3 \circ f_1) \otimes (f_4 \circ f_2)$$

holds in the underlying category of denotations. This ensures that the first equation of bifactoriality is satisfied. One deduces in a similar way the other equation

$$id_{[A]\otimes[B]} = id_{[A]} \otimes id_{[B]}$$

by noting that the cut-elimination procedure transforms the proof

$$\frac{}{A \otimes B \vdash A \otimes B} \text{Axiom}$$

into the proof

$$\text{Axiom} \frac{\frac{}{A \vdash A} \text{Axiom} \quad \frac{}{B \vdash B} \text{Axiom}}{A, B \vdash A \otimes B} \text{Right } \otimes \quad \frac{A, B \vdash A \otimes B}{A \otimes B \vdash A \otimes B} \text{Left } \otimes$$

by the η -expansion rule described in Chapter 3, Section 3.5.

2.3 Proof invariants organize themselves as monoidal categories (1)

We have just explained the reasons why the operation \otimes defines a bifunctor on the category of denotations. We can go further, and show that this bifunctor defines a monoidal category — not exactly monoidal in fact, but nearly so. The reader will find the notion of monoidal category recalled in Chapter 4.

A preliminary step in order to define a monoidal category is to choose a unit object e in the category. The choice is almost immediate in the case of linear logic. In classical and intuitionistic logic, the truth value T standing for “true” behaves as a kind of *unit* for conjunction, since the two sequents

$$A \wedge T \vdash A \quad \text{and} \quad A \vdash A \wedge T$$

are provable for every formula A of the logic. In linear logic, the truth value T is replaced by a constant 1 which plays exactly the same role for the tensor product. In particular, the two sequents

$$A \otimes 1 \vdash A \quad \text{and} \quad A \vdash A \otimes 1$$

are provable for every formula A of linear logic. The *unit* of the category is thus defined as the denotation $e = [1]$ of the formula 1 .

Now, we construct three isomorphisms

$$\alpha_{A,B,C} : (A \otimes B) \otimes C \longrightarrow A \otimes (B \otimes C),$$

$$\lambda_A : e \otimes A \longrightarrow A, \quad \rho_A : A \otimes e \longrightarrow A$$

indexed on the objects A, B, C of the category, which satisfy all the coherence and naturality conditions of a monoidal category. The associativity morphism α

$$\begin{array}{c}
\frac{\frac{\frac{A_1 \vdash A_1}{A_1, B_1, C_1 \vdash A_1 \otimes (B_1 \otimes C_1)}}{A_1 \otimes B_1, C_1 \vdash A_1 \otimes (B_1 \otimes C_1)}}{(A_1 \otimes B_1) \otimes C_1 \vdash A_1 \otimes (B_1 \otimes C_1)} \quad \frac{\frac{\frac{B_1 \vdash B_1}{B_1, C_1 \vdash B_1 \otimes C_1}}{A_1, B_1, C_1 \vdash B_1 \otimes C_1}}{A_1 \otimes (B_1 \otimes C_1) \vdash A_2 \otimes (B_2 \otimes C_2)} \quad \frac{\frac{\frac{C_1 \vdash C_1}{B_1, C_1 \vdash B_2 \otimes C_2}}{B_1 \otimes C_1 \vdash B_2 \otimes C_2}}{A_1 \otimes (B_1 \otimes C_1) \vdash A_2 \otimes (B_2 \otimes C_2)} \quad \frac{\frac{\frac{\pi_1}{\vdots}}{A_1 \vdash A_2}}{A_1 \otimes (B_1 \otimes C_1) \vdash A_2 \otimes (B_2 \otimes C_2)} \quad \frac{\frac{\frac{\pi_2}{\vdots}}{B_1 \vdash B_2}}{B_1 \otimes C_1 \vdash B_2 \otimes C_2}}{A_1 \otimes (B_1 \otimes C_1) \vdash A_2 \otimes (B_2 \otimes C_2)} \quad \frac{\frac{\frac{\pi_3}{\vdots}}{C_1 \vdash C_2}}{A_1 \otimes (B_1 \otimes C_1) \vdash A_2 \otimes (B_2 \otimes C_2)} \\
\hline
(A_1 \otimes B_1) \otimes C_1 \vdash A_2 \otimes (B_2 \otimes C_2) \quad \text{Cut}
\end{array}$$

By modularity, the two proofs have

$$\alpha \circ ((f_1 \otimes f_2) \otimes f_3) \quad \text{and} \quad (f_1 \otimes (f_2 \otimes f_3)) \circ \alpha.$$

as respective denotations. Now, the two proofs reduce by cut-elimination to the same proof:

$$\begin{array}{c}
\frac{\frac{\frac{\pi_1}{\vdots}}{A_1 \vdash A_2} \quad \frac{\frac{\pi_2}{\vdots}}{B_1 \vdash B_2}}{A_1, B_1 \vdash A_2 \otimes B_2} \text{Right } \otimes \quad \frac{\frac{\pi_3}{\vdots}}{C_1 \vdash C_2} \text{Right } \otimes \\
\frac{\frac{\frac{A_1, B_1, C_1 \vdash (A_2 \otimes B_2) \otimes C_2}{A_1, B_1 \otimes C_1 \vdash (A_2 \otimes B_2) \otimes C_2} \text{Left } \otimes}{A_1 \otimes (B_1 \otimes C_1) \vdash (A_2 \otimes B_2) \otimes C_2} \text{Left } \otimes
\end{array}$$

which is simply the original proof of associativity in which every axiom step

$$\frac{}{A \vdash A} \quad \frac{}{B \vdash B} \quad \frac{}{C \vdash C}$$

has been replaced by the respective proof

$$\frac{\frac{\pi_1}{\vdots}}{A_1 \vdash A_2} \quad \frac{\frac{\pi_2}{\vdots}}{B_1 \vdash B_2} \quad \frac{\frac{\pi_3}{\vdots}}{C_1 \vdash C_2}$$

The very fact that the two proofs reduce to the same proof, and that denotation is invariant under cut-elimination, ensures that the equality

$$\alpha \circ ((f_1 \otimes f_2) \otimes f_3) = (f_1 \otimes (f_2 \otimes f_3)) \circ \alpha.$$

holds. We conclude that the categorical diagram (16) commutes, and thus, that the family α of associativity morphisms is natural. The other naturality and coherence conditions required of a monoidal category are established in just the same way.

2.4 Proof invariants organize themselves as monoidal categories (2)

In order to conclude that the tensor product \otimes defines a monoidal category of denotations, there only remains to check that the three morphisms α , λ and ρ are isomorphisms. Interestingly, this is not necessarily the case! The expected inverse of the three morphisms α , λ and ρ are the denotations $\bar{\alpha}$, $\bar{\lambda}$ and $\bar{\rho}$ of the three proofs below:

$$\frac{\text{Axiom} \frac{\overline{A \vdash A} \quad \overline{B \vdash B}}{A, B \vdash A \otimes B} \quad \text{Axiom} \frac{\overline{C \vdash C}}{C \vdash C}}{\text{Right } \otimes} \quad \frac{\overline{A, B, C \vdash (A \otimes B) \otimes C}}{\text{Left } \otimes} \quad \frac{\overline{A, B \otimes C \vdash (A \otimes B) \otimes C}}{\text{Left } \otimes}}{A \otimes (B \otimes C) \vdash (A \otimes B) \otimes C} \text{Left } \otimes$$

and

$$\text{Right } 1 \frac{\overline{\vdash 1} \quad \overline{A \vdash A}}{A \vdash 1 \otimes A} \text{Axiom} \text{Right } \otimes$$

and

$$\text{Axiom} \frac{\overline{A \vdash A} \quad \overline{\vdash 1}}{A \vdash A \otimes 1} \text{Right } 1 \text{Right } \otimes$$

It is not difficult to deduce the following two equalities from invariance and modularity:

$$\lambda \circ \bar{\lambda} = id_A, \quad \rho \circ \bar{\rho} = id_A.$$

On the other hand, and quite surprisingly, none of the four expected equalities

$$\begin{aligned} \bar{\lambda} \circ \lambda &= id_{e \otimes A}, & \bar{\rho} \circ \rho &= id_{A \otimes e}, \\ \bar{\alpha} \circ \alpha &= id_{(A \otimes B) \otimes C}, & \alpha \circ \bar{\alpha} &= id_{A \otimes (B \otimes C)}, \end{aligned}$$

is necessarily satisfied by the category of denotations. Typically, modularity ensures that the morphism $\bar{\rho} \circ \rho$ denotes the proof

$$\frac{\frac{\overline{A \vdash A} \text{Axiom}}{A, 1 \vdash A} \text{Left } 1 \quad \frac{\overline{A \vdash A} \text{Axiom} \quad \overline{\vdash 1} \text{Right } 1}}{A \otimes 1 \vdash A} \text{Left } \otimes \quad \frac{\overline{A \vdash A} \text{Axiom} \quad \overline{\vdash 1} \text{Right } 1}}{A \vdash A \otimes 1} \text{Right } \otimes}}{A \otimes 1 \vdash A \otimes 1} \text{Cut}$$

which is transformed by cut-elimination into the proof

$$\frac{\frac{\overline{A \vdash A} \text{Axiom}}{A, 1 \vdash A} \text{Left } 1 \quad \overline{\vdash 1} \text{Right } 1}{A \otimes 1 \vdash A} \text{Left } \otimes \quad \overline{\vdash 1} \text{Right } 1}{A \otimes 1 \vdash A \otimes 1} \text{Right } \otimes} \quad (17)$$

Strictly speaking, invariance, modularity and tensoriality do not force that the proof (17) has the same denotation as the η -expansion of the identity:

$$\frac{\frac{\overline{A \vdash A} \text{ Axiom} \quad \overline{1 \vdash 1} \text{ Axiom}}{\overline{A, 1 \vdash A \otimes 1} \text{ Right } \otimes}}{\overline{A \otimes 1 \vdash A \otimes 1} \text{ Left } \otimes} \quad (18)$$

at least if we are careful to define the cut-elimination procedure of linear logic in the slightly unconventional but extremely careful way given in Chapter 3.

2.5 Proof invariants organize themselves as monoidal categories (3)

However, we are not very far at this point from obtaining a monoidal category of denotations. To that purpose, it is sufficient to require a series of basic equalities in addition to invariance, modularity and tensoriality. For every two proofs π_1 and π_2 , we require first that the proof

$$\frac{\frac{\frac{\pi_1}{\vdots}}{\overline{\Gamma, C, D \vdash A}} \text{ Left } \otimes \quad \frac{\pi_2}{\vdots}}{\overline{\Gamma, C \otimes D \vdash A \otimes B} \text{ Right } \otimes} \quad (19)$$

has the same denotation as the proof

$$\frac{\frac{\frac{\pi_1}{\vdots}}{\overline{\Gamma, C, D \vdash A}} \quad \frac{\pi_2}{\vdots}}{\overline{\Gamma, C, D, \Delta \vdash A \otimes B} \text{ Right } \otimes} \text{ Left } \otimes \quad (20)$$

obtained by “permuting” the left and right introduction of the tensor product. We require symmetrically that the proof

$$\frac{\frac{\pi_1}{\vdots} \quad \frac{\frac{\pi_2}{\vdots}}{\overline{\Delta, C, D \vdash B}}}{\overline{\Gamma \vdash A} \quad \overline{\Delta, C \otimes D \vdash B} \text{ Left } \otimes} \text{ Right } \otimes \quad (21)$$

has the same denotation as the proof

$$\frac{\frac{\pi_1}{\vdots} \quad \frac{\frac{\pi_2}{\vdots}}{\overline{\Delta, C, D \vdash B}}}{\overline{\Gamma \vdash A} \quad \overline{\Delta, C \otimes D \vdash B} \text{ Right } \otimes} \text{ Left } \otimes \quad (22)$$

obtained by “permuting” the left and right introduction of the tensor product. We also require that the two proofs

$$\frac{\frac{\frac{\pi_1}{\vdots}}{\Gamma \vdash A} \text{Left } 1 \quad \frac{\frac{\pi_2}{\vdots}}{\Delta \vdash B} \text{Right } \otimes}{\Gamma, 1, \Delta \vdash A \otimes B} \text{Right } \otimes \quad (23)$$

and

$$\frac{\frac{\frac{\pi_1}{\vdots}}{\Gamma \vdash A} \quad \frac{\frac{\pi_2}{\vdots}}{\Delta \vdash B} \text{Left } 1}{\frac{\frac{\pi_1}{\vdots}}{\Gamma \vdash A} \quad \frac{\pi_2}{1, \Delta \vdash B} \text{Right } \otimes} \text{Left } 1 \quad (24)$$

have the same denotation as the proof

$$\frac{\frac{\frac{\pi_1}{\vdots}}{\Gamma \vdash A} \quad \frac{\pi_2}{\Delta \vdash B} \text{Right } \otimes}{\frac{\Gamma, \Delta \vdash A \otimes B}{\Gamma, 1, \Delta \vdash A \otimes B} \text{Left } 1} \text{Left } 1 \quad (25)$$

obtained by “relocating” the left introduction of the unit 1 from the sequent $\Gamma \vdash A$ or the sequent $\Delta \vdash B$ to the sequent $\Gamma, \Delta \vdash A \otimes B$.

Once these four additional equalities are satisfied, the original hypothesis of invariance, modularity and tensoriality of denotations implies the desired equalities:

$$\begin{aligned} \bar{\lambda} \circ \lambda &= id_{e \otimes A}, & \bar{\rho} \circ \rho &= id_{A \otimes e}, \\ \bar{\alpha} \circ \alpha &= id_{(A \otimes B) \otimes C}, & \alpha \circ \bar{\alpha} &= id_{A \otimes (B \otimes C)}. \end{aligned}$$

Hence, the three morphisms α , λ and ρ are isomorphisms in the category of denotations, with respective inverse $\bar{\alpha}$, $\bar{\lambda}$ and $\bar{\rho}$. We conclude in that case that the category of denotations is monoidal.

Remark. The discussion above is mainly intended to the practiced reader in proof theory. The cut-elimination procedure described in Chapter 3 is designed extremely carefully, in order to avoid a few typically unnecessary proof transformations. Once this iron discipline is adopted for cut-elimination, the equalities between proofs mentioned above like (19)=(20) or (21)=(22) are not necessarily satisfied: consequently, the category of denotations is not necessarily monoidal. The point is far from anecdotic. It is related to the interpretation of proofs as concurrent strategies playing on asynchronous games, introduced in joint work with Samuel Mimram [74] – an interactive interpretation of proofs which does not enforce these equalities. It is also related to proof-nets and the status of

units in free $*$ -autonomous categories – as observed independently by Dominic Hughes in recent work [48].

On the other hand, one should stress that the cut-elimination procedures defined in the literature are generally more permissive than ours, in the sense that more proof transformations are accepted than it is strictly necessary for cut-elimination. We will see in Chapter 3 (more precisely in Section 3.12) that when such a permissive policy is adopted, the three principles of invariance, modularity and tensoriality imply the equalities just mentioned: hence, the category of denotations is necessarily monoidal in that case.

2.6 Conversely, what is a categorical model of linear logic?

We have recognized that every (invariant, modular, tensorial) denotation defines a monoidal category of denotations, at least when the cut-elimination procedure is sufficiently permissive. There remains to investigate the converse question: what axioms should a given monoidal category \mathbf{C} satisfy in order to define a modular and tensorial invariant of proofs?

The general principle of the interpretation is that every sequent

$$A_1, \dots, A_m \vdash B$$

of linear logic will be interpreted as a morphism

$$[A_1] \otimes \dots \otimes [A_m] \longrightarrow [B]$$

in the category \mathbf{C} , where we write $[A]$ for the object which denotes the formula A in the category. This object $[A]$ is computed by induction on the size of the formula A in the expected way. Typically,

$$[A \otimes B] = [A] \otimes [B]$$

This explains why the category \mathbf{C} should admit, at least, a tensor product. It is then customary to write

$$[\Gamma] = [A_1] \otimes \dots \otimes [A_m]$$

for the denotation of the context

$$\Gamma = A_1, \dots, A_m$$

as an object of the category \mathbf{C} . The notation enables to restate the principle of the interpretation in a nice and concise way: every proof of the sequent

$$\Gamma \vdash B$$

will be interpreted as a morphism

$$[\Gamma] \longrightarrow [B]$$

in the category \mathbf{C} . The interpretation of a proof π is defined by induction on the “depth” of its derivation tree. In the same typical way, the axiom rule

$$\frac{}{A \vdash A} \text{Axiom}$$

is interpreted as the identity morphism on the interpretation of the formula A .

$$id_{[A]} : [A] \longrightarrow [A].$$

Also typically, given two proofs

$$\frac{\begin{array}{c} \pi_1 \\ \vdots \end{array}}{\Gamma \vdash A} \qquad \frac{\begin{array}{c} \pi_2 \\ \vdots \end{array}}{\Delta \vdash B}$$

interpreted as morphisms

$$f : [\Gamma] \longrightarrow [A] \qquad g : [\Delta] \longrightarrow [B]$$

in the category \mathbf{C} , the proof

$$\frac{\frac{\begin{array}{c} \pi_1 \\ \vdots \end{array}}{\Gamma \vdash A} \quad \frac{\begin{array}{c} \pi_2 \\ \vdots \end{array}}{\Delta \vdash B}}{\Gamma, \Delta \vdash A \otimes B} \text{Right } \otimes$$

is interpreted as the morphism

$$[\Gamma] \otimes [\Delta] \xrightarrow{f \otimes g} [A] \otimes [B]$$

in the monoidal category \mathbf{C} .

Beyond these basic principles, the structures and properties required of a category \mathbf{C} in order to provide an invariant of proofs depend on the fragment (or variant) of linear logic one has in mind: commutative or non-commutative, classical or intuitionistic, additive or non-additive, etc. In each case, we sketch below what kind of axioms should a monoidal category \mathbf{C} satisfy in order to define an invariant of proofs.

Commutative vs. non-commutative logic

Linear logic is generally understood as a commutative logic, this meaning that there exists a canonical proof of the sequent $A \otimes B \vdash B \otimes A$ for every formula A and B . The proof is constructed as follows.

$$\frac{\frac{\frac{\frac{}{B \vdash B} \text{Axiom}}{B, A \vdash B \otimes A} \text{Right } \otimes}{} \text{Axiom}}{A, B \vdash B \otimes A} \text{Exchange}}{A \otimes B \vdash B \otimes A} \text{Left } \otimes$$

For this reason, usual (commutative) linear logic is interpreted in monoidal categories equipped with a notion of symmetry – and thus called *symmetric* monoidal categories; see Section 4.4 in Chapter 4 for a definition.

On the other hand, several non-commutative variants of linear logic have been considered in the literature, in which the exchange rule:

$$\frac{\Gamma, A, B, \Delta \vdash C}{\Gamma, B, A, \Delta \vdash C} \text{ Exchange}$$

has been removed, or replaced by a restricted version. These non-commutative variants of linear logic are interpreted in monoidal categories, possibly equipped with a suitable notion of permutation, like a braiding; see Section 4.3 in Chapter 4 for a definition.

Classical linear logic and duality

In his original article, Jean-Yves Girard introduced a *classical* linear logic, in which sequents are one-sided:

$$\vdash A_1, \dots, A_n.$$

The main feature of the logic is a duality principle, based on an involutive negation:

- every formula A has a negation A^\perp ,
- the negation of the negation $A^{\perp\perp}$ of a formula A is the formula A itself.

From this, a new connective \wp can be defined by duality:

$$(A \wp B) = (B^\perp \otimes A^\perp)^\perp.$$

This leads to an alternative presentation of linear logic, based this time on two-sided sequents:

$$A_1, \dots, A_m \vdash B_1, \dots, B_n. \quad (26)$$

We have seen in Chapter 1 that in classical logic, any such two-sided sequent stands for the formula

$$A_1 \wedge \dots \wedge A_m \Rightarrow B_1 \vee \dots \vee B_n.$$

Similarly, it stands in linear logic for the formula

$$A_1 \otimes \dots \otimes A_m \multimap B_1 \wp \dots \wp B_n$$

where \multimap is implication in linear logic. The notion of linearly distributive category introduced by Robin Cockett and Robert Seely, and recalled in Chapter 4 of this survey, is a category equipped with *two* monoidal structures \otimes and \bullet whose task is precisely to interpret such a two-sided sequent (26) as a morphism

$$[A_1] \otimes \dots \otimes [A_m] \longrightarrow [B_1] \bullet \dots \bullet [B_n]$$

in the category.

Intuitionistic linear logic and linear implication \multimap

The *intuitionistic* fragment of linear logic was later extracted from classical linear logic by restricting the two-sided sequents (26) to “intuitionistic” sequents

$$A_1, \dots, A_m \vdash B$$

in which several formulas may appear on the left-hand side of the sequent, but only one formula appears on the right-hand side. We have seen in the introduction (Chapter 1) that Heyting applied the same trick to classical logic in order to formalize intuitionistic logic. This is the reason for calling “intuitionistic” this fragment of linear logic.

Duality disappears in the typical accounts of intuitionistic linear logic: the original connectives of linear logic are limited to the tensor product \otimes , the unit $\mathbf{1}$, and the linear implication \multimap . The right introduction of linear implication is performed by the rule:

$$\frac{A, \Gamma \vdash B}{\Gamma \vdash A \multimap B} \text{ Right } \multimap$$

which may be interpreted in a monoidal closed category; see Chapter 4 of this survey for a definition.

The additive conjunction & of linear logic

One important discovery of linear logic is the existence of *two* different conjunctions in logic:

- a “multiplicative” conjunction called “tensor” and noted \otimes because it behaves like a tensor product in linear algebra,
- another “additive” conjunction called “with” and noted $\&$ which behaves like a cartesian product in linear algebra.

In intuitionistic linear logic, the right introduction of the connective $\&$ is performed by the rule:

$$\frac{\Gamma \vdash A \quad \Gamma \vdash B}{\Gamma \vdash A \& B} \quad (27)$$

The left introduction of the connective $\&$ is performed by two different rules:

$$\frac{\Gamma, A, \Delta \vdash C}{\Gamma, A \& B, \Delta \vdash C} \quad \frac{\Gamma, B, \Delta \vdash C}{\Gamma, A \& B, \Delta \vdash C} \quad (28)$$

The additive conjunction $\&$ is generally interpreted as a cartesian product in a monoidal category \mathbf{C} . Suppose indeed that $\Gamma = X_1, \dots, X_m$ is a context, and that π_A and π_B are two proofs

$$\frac{\pi_A}{\Gamma \vdash A} \quad \frac{\pi_B}{\Gamma \vdash B}$$

of the sequents on top of the right introduction rule (27). Suppose moreover that the proofs π_A and π_B are interpreted by the morphisms:

$$f : [\Gamma] \longrightarrow [A] \qquad g : [\Gamma] \longrightarrow [B]$$

in the monoidal category \mathbf{C} . In order to interpret the proof

$$\frac{\frac{\pi_A}{\vdots} \quad \frac{\pi_B}{\vdots}}{\Gamma \vdash A \quad \Gamma \vdash B} \text{Right } \& \qquad (29)$$

$$\frac{}{\Gamma \vdash A \& B}$$

let us suppose from now on that every pair of objects A and B in the category \mathbf{C} has a cartesian product noted $A \& B$. Then, by definition of a cartesian product, the pair of morphisms f and g gives rise to a unique morphism

$$\langle f, g \rangle : [\Gamma] \longrightarrow [A] \& [B]$$

making the diagram

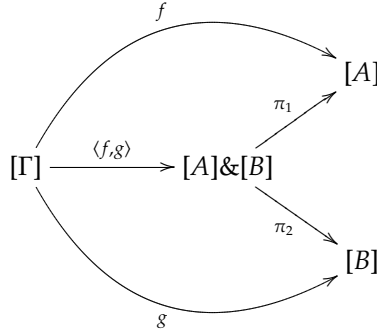

commute in the category \mathbf{C} . In the diagram, the two morphisms π_1 and π_2 denote the first and second projection of the cartesian product. Now, we define the interpretation of the formula $A \& B$ as expected:

$$[A \& B] = [A] \& [B]$$

and interpret the proof (29) as the morphism $\langle f, g \rangle$.

The two left introduction rules (28) are interpreted by pre-composing with the first or second projection of the cartesian product $[A] \& [B]$. For illustration, consider a proof

$$\frac{\pi}{\vdots}}{\Gamma, B, \Delta \vdash C}$$

interpreted as the morphism

$$f : [\Gamma] \otimes [A] \otimes [\Delta] \longrightarrow [C]$$

in the category \mathbf{C} . Then, the proof

$$\frac{\frac{\pi}{\vdots}}{\Gamma, B, \Delta \vdash C} \text{Left } \&_1 \\ \frac{}{\Gamma, A \& B, \Delta \vdash C}$$

is interpreted as the morphism

$$[\Gamma] \otimes [A \& B] \otimes [\Delta] \xrightarrow{[\Gamma] \otimes \pi_1 \otimes [\Delta]} [\Gamma] \otimes [A] \otimes [\Delta] \xrightarrow{f} [C].$$

Exponential modality

The main difficulty of the field is to understand the categorical properties of the exponential modality $!$ of linear logic. This question has been much debated in the past, sometimes with extreme vigor. It seems however that we have reached a state of agreement, or at least relative equilibrium, in the last few years. People have realized indeed that all the axiomatizations appearing in the literature converge to a unique notion: a well-behaved (that is: symmetric monoidal) adjunction

$$\begin{array}{ccc} & L & \\ \mathbb{M} & \begin{array}{c} \curvearrowright \\ \perp \\ \curvearrowleft \end{array} & \mathbb{L} \\ & M & \end{array}$$

between:

- a symmetric monoidal closed category \mathbb{L} ,
- a cartesian category \mathbb{M} .

By cartesian category, we mean a category with finite products: the category has a terminal object, and every pair of objects A and B has a cartesian product.

An adjunction $L \dashv M$ satisfying these properties is called a *linear-non-linear adjunction*; see Definition 21 at the beginning of Chapter 7. Every such adjunction provides a categorical model of *intuitionistic* linear logic, which becomes a model of *classical* linear logic when the category \mathbb{L} is not only symmetric monoidal closed, but also $*$ -autonomous. The exponential modality $!$ is then interpreted as the comonad

$$! = L \circ M$$

induced on the category \mathbb{L} by the linear-non-linear adjunction. We will come back to this point in Chapter 7 of the survey, where we review four alternative definitions of a categorical model of linear logic, and extract in each case a particular linear-non-linear adjunction.

2.7 Proof invariants and free categories

Proof theory is in many respects similar to knot theory: the mathematical study of a purely combinatorial structure (proofs instead of knots) regulated by symbolic transformations (cut-elimination instead of topological deformation). Recent advances in proof theory establish that this analogy is not only superficial: in fact, it appears that categorical semantics plays the same rôle for proofs as representation theory for knots.

Think of knot theory for a minute. A general recipe for computing knot invariants is to construct a monoidal category \mathbf{C} equipped with a *braiding* and a *duality*. It appears indeed that every object in a category of this kind provides an invariant of knots under topological deformation, formulated as Reidemeister moves. In order to establish this fact, one constructs a category \mathbb{T} with natural numbers as objects, and knots (or rather *tangles*) as morphisms – see the nice monographs by Christian Kassel [59] and Ross Street [86] for additional information on the topic. The category \mathbb{T} is monoidal with the tensor product of two objects m and n defined as their arithmetic sum:

$$m \otimes n \quad := \quad m + n$$

and the tensor product of two tangles $f_1 : m_1 \rightarrow n_1$ and $f_2 : m_2 \rightarrow n_2$ defined as the tangle $f_1 \otimes f_2 = m_1 + m_2 \rightarrow n_1 + n_2$ obtained by drawing the two tangles f_1 and f_2 side by side. One shows that the resulting category \mathbb{T} is presented (as a monoidal category) by a finite number of generators and relations, corresponding in fact to the notion of braiding and duality. This establishes that:

- the monoidal category \mathbb{T} is equipped with a braiding and a duality,
- the category \mathbb{T} is the free such category, in the sense that for every object X in a monoidal category \mathbf{C} with braiding and duality, there exists a unique structure preserving functor F from the category \mathbb{T} of tangles to the category \mathbf{C} , such that $F(1) = X$.

The notions of braiding and of duality are recalled in Chapter 4. By structure preserving functor, we mean that F transports the monoidal structure, the braiding and the duality of the category of tangles to the category \mathbf{C} .

Exactly the same categorical recipe is followed in proof theory. Typically, one constructs a free symmetric monoidal closed category **free-smcc**(\mathbf{X}) over a category \mathbf{X} in the following way. Its objects are the formulas constructed using the binary connectives \otimes and \multimap , the logical unit 1 , and the objects X, Y of the original category \mathbf{X} , understood here as additional atomic formulas. The morphisms $A \rightarrow B$ of the category are the proofs of the sequent $A \vdash B$ in intuitionistic linear logic, considered modulo cut-elimination. In order to deal with the morphisms of \mathbf{C} , the original sequent calculus is extended by a family of axioms

$$X \vdash Y$$

on atomic formulas, one such axiom for each morphism

$$f \quad : \quad X \rightarrow Y$$

in the category \mathbb{X} . The cut-elimination procedure is extended accordingly by the composition law of the category \mathbb{X} , which expresses how to handle these additional axioms. Because the logic is a fragment of intuitionistic logic, the morphisms of the category $\mathbf{free-smcc}(\mathbb{X})$ may be alternatively seen as derivation trees modulo cut-elimination, or as (in that case, linear) λ -terms modulo $\beta\eta$ -conversion. This construction is the straightforward adaptation of the construction of the free cartesian closed category over a category \mathbb{X} , given by Joachim Lambek and Phil Scott [65].

Then, in the same way as in knot theory, a proof invariant follows from a structure preserving functor F from the category $\mathbf{free-smcc}(\mathbb{X})$ to a symmetric monoidal closed category \mathbb{C} . By structure preserving, we mean in that case a strong and symmetric monoidal functor (F, m) satisfying moreover that the canonical morphism

$$F(A \multimap B) \longrightarrow F(A) \multimap F(B)$$

deduced from the morphism

$$F(A) \otimes F(A \multimap B) \xrightarrow{m_{A, A \multimap B}} F(A \otimes A \multimap B) \xrightarrow{F(\text{eval}_{A,B})} F(B)$$

is an isomorphism, for every object A and B of the source category. The definition of monoidal functor and of its variants is recalled in Chapter 5.

Although the study of free categories is a fundamental aspect of proof theory, we will not develop the topic further in this survey, for lack of space. Let us simply mention that the analogy between proof theory and knot theory leads to promising and largely unexplored territories. The free symmetric monoidal closed category $\mathbf{free-smcc}(\mathbb{X})$ is constructed by purely symbolic means. This conveys the false impression that proof theory is inherently syntactical. However, this somewhat pessimistic vision of logic is dismissed by shifting to alternative categorical accounts of proofs. Typically, define a *dialogue category* as a symmetric monoidal category equipped with a negation

$$A \mapsto \neg A$$

instead of a linear implication

$$(A, B) \mapsto A \multimap B.$$

The formal definition of dialogue category appears in Section 4.14 at the end of Chapter 4. It appears then that the free dialogue category over a category \mathbb{X} is very similar in style to the category \mathbb{T} of tangles considered in knot theory. Its objects are dialogue games and its morphisms are innocent strategies, in the sense defined by Martin Hyland and Luke Ong in their seminal article on game semantics [49]. The key point is that these strategies are seen as topological entities, given by string diagrams, in the same way as tangles in knot theory. The interested reader will find in [69, 44] alternative accounts on innocence.

At this point of analysis, game semantics is naturally seen as a topological description of proofs, similar to knots. Once this point understood, the two

fields are in fact so homogenous in style that it becomes possible to cross-breed them, and for instance to consider braided notions of proofs and strategies, etc. This leads us outside the scope of this survey, and we stop here... although we briefly come back to this discussion in the conclusion (Chapter 9).

2.8 Notes and references

Several variants of non-commutative linear logic have been introduced in the literature, starting with the cyclic linear logic formulated by Jean-Yves Girard, and described by David Yetter in [90]. Interestingly, Joachim Lambek started the idea of using non commutative and linear fragments of logic as early as 1958 in order to parse sentences in English and other vernacular languages, see [64]. One motivation for cyclic linear logic is topological: cyclic linear logic generates exactly the *planar proofs* of linear logic. By planar proof, one means a proof whose proof-net is planar, see [40]. Cyclic linear logic was later extended in several ways: to a non-commutative logic by Paul Ruet [1] to a planar logic by the author [71] and more recently to a permutative logic by Jean-Marc Andreoli, Gabriele Pulcini and Paul Ruet [3]. Again, these logics are mainly motivated by the topological properties of the proofs they generate: planarity, etc. Another source of interest for non commutative variants of linear logic arises from the Curry-Howard isomorphism between proofs and programs. Typically, Frank Pfenning and Jeff Polakow [78] study a non-commutative extension of intuitionistic linear logic, in which non-commutativity captures the stack discipline of standard continuation passing style translations.

There remains a lot of work to clarify how the various non-commutative logics are related, in particular on the semantic side. In that direction, one should mention the early work by Rick Blute and Phil Scott on Hopf algebras and cyclic linear logic [18, 20]. In Chapter 4, we will investigate two non-commutative variants of well-known categorical models of multiplicative linear logic: the linearly distributive categories introduced by Robin Cockett and Robert Seely in [26], and the non symmetric $*$ -autonomous categories formalized by Michael Barr in [8].

3 Linear logic and its cut-elimination procedure

In this chapter, we introduce propositional linear logic, understood now as a formal proof system. First, we describe the sequent calculus of classical linear logic (LL) and explain how to specialize it to its intuitionistic fragment (ILL). Then, we describe in full detail the cut-elimination procedure in the intuitionistic fragment. As we briefly explained in Chapter 2, we are extremely careful to limit the procedure to its necessary steps – so as not to identify too many proofs semantically. Finally, we return to classical linear logic and explain briefly how to adapt the cut-elimination procedure to the classical system.

3.1 Classical linear logic

The formulas

The formulas of propositional linear logic are constructed by an alphabet of four nullary constructors called *units*:

$$0 \quad 1 \quad \perp \quad \top$$

two unary constructors called *modalities*:

$$!A \quad ?A$$

and four binary constructors called *connectives*:

$$A \oplus B \quad A \otimes B \quad A \wp B \quad A \& B$$

Each constructor receives a specific name in the folklore of linear logic. Each constructor is also classified: *additive*, *multiplicative*, or *exponential*, depending on its nature and affinities with other constructors. This is recalled in the table below.

\oplus 0 & \top	plus zero: the unit of \oplus with top: the unit of &	The additives
\otimes 1 \wp \perp	tensor product one: the unit of \otimes parallel product bottom: the unit of \wp	The multiplicatives
! ?	bang (or shriek) why not	The exponential modalities

The sequents

The sequents are *one-sided*

$$\vdash A_1, \dots, A_n$$

understood as *sequences* of formulas, not sets. In particular, the same formula A may appear twice (consecutively) in the sequence: this is precisely what happens when the contraction rule applies.

The sequent calculus

A proof of propositional linear logic is constructed according to a series of rules presented in Figure 1. Note that there is no distinction between “Left” and “Right” introduction rules, since every sequent is one-sided.

Axiom	$\frac{}{\vdash A^\perp, A}$	Cut	$\frac{\vdash \Gamma, A \quad \vdash A^\perp, \Delta}{\vdash \Gamma, \Delta}$
\otimes	$\frac{\vdash \Gamma, A \quad \vdash \Delta, B}{\vdash \Gamma, \Delta, A \otimes B}$	\wp	$\frac{\vdash \Gamma, A, B}{\vdash \Gamma, A \wp B}$
1	$\frac{}{\vdash 1}$	\perp	$\frac{\vdash \Gamma}{\vdash \Gamma, \perp}$
\oplus_1	$\frac{\vdash \Gamma, A}{\vdash \Gamma, A \oplus B}$	$\&$	$\frac{\vdash \Gamma, A \quad \vdash \Gamma, B}{\vdash \Gamma, A \& B}$
\oplus_2	$\frac{\vdash \Gamma, B}{\vdash \Gamma, A \oplus B}$		
0	no rule	\top	$\frac{}{\vdash \Gamma, \top}$
Contraction	$\frac{\vdash \Gamma, ?A, ?A}{\vdash \Gamma, ?A}$	Weakening	$\frac{\vdash \Gamma}{\vdash \Gamma, ?A}$
Dereliction	$\frac{\vdash \Gamma, A}{\vdash \Gamma, ?A}$	Promotion	$\frac{\vdash ?\Gamma, A}{\vdash ?\Gamma, !A}$

Figure 1: Sequent calculus of linear logic (LL)

3.2 Intuitionistic linear logic

The formulas

The formulas of propositional intuitionistic linear logic (with additives) are constructed by an alphabet of two *units*:

$$1 \quad \top$$

one modality:

$$!A$$

and three connectives:

$$A \otimes B \quad A \multimap B \quad A \& B$$

The connective \multimap is called linear implication.

The sequents

The sequents are *intuitionistic*, that is, two-sided

$$A_1, \dots, A_m \vdash B$$

with a *sequence* of formulas A_1, \dots, A_m on the left-hand side, and a *unique* formula B on the right-hand side.

The sequent calculus

A proof of propositional intuitionistic linear logic is constructed according to a series of rules presented in Figure 2. We follow the tradition, and call “intuitionistic linear logic” the intuitionistic fragment without the connective $\&$ nor unit \top . Then, “intuitionistic linear logic *with finite products*” is the logic extended with the four rules of Figure 3.

3.3 Cut-elimination in intuitionistic linear logic

The cut-elimination procedure is described as a series of symbolic transformations on proofs in Sections 3.4 – 3.11.

3.4 Cut-elimination: commuting conversion cut vs. cut

3.4.1 Commuting conversion cut vs. cut (first case)

The proof

$$\frac{\frac{\frac{\pi_1}{\vdots}}{\Gamma \vdash A} \quad \frac{\frac{\frac{\pi_2}{\vdots}}{\Upsilon_2, A, \Upsilon_3 \vdash B} \quad \frac{\frac{\pi_3}{\vdots}}{\Upsilon_1, B, \Upsilon_4 \vdash C}}{\Upsilon_1, \Upsilon_2, A, \Upsilon_3, \Upsilon_4 \vdash C} \text{Cut}}{\Upsilon_1, \Upsilon_2, \Gamma, \Upsilon_3, \Upsilon_4 \vdash C} \text{Cut}}$$

is transformed into the proof

$$\frac{\frac{\frac{\pi_1}{\vdots}}{\Gamma \vdash A} \quad \frac{\frac{\pi_2}{\vdots}}{\Upsilon_2, A, \Upsilon_3 \vdash B}}{\Upsilon_2, \Gamma, \Upsilon_3 \vdash B} \text{Cut} \quad \frac{\frac{\pi_3}{\vdots}}{\Upsilon_1, B, \Upsilon_4 \vdash C}}{\Upsilon_1, \Upsilon_2, \Gamma, \Upsilon_3, \Upsilon_4 \vdash C} \text{Cut}}$$

and conversely. In other words, the two proofs are equivalent from the point of view of the cut-elimination procedure. This point has already been mentioned in Section 2.1 of Chapter 2: this commutative conversion ensures that composition is associative in the category induced by any invariant and modular denotation of proofs.

Axiom	$\frac{}{A \vdash A}$
Cut	$\frac{\Gamma \vdash A \quad \Upsilon_1, A, \Upsilon_2 \vdash B}{\Upsilon_1, \Gamma, \Upsilon_2 \vdash B}$
Left \otimes	$\frac{\Upsilon_1, A, B, \Upsilon_2 \vdash C}{\Upsilon_1, A \otimes B, \Upsilon_2 \vdash C}$
Right \otimes	$\frac{\Gamma \vdash A \quad \Delta \vdash B}{\Gamma, \Delta \vdash A \otimes B}$
Left \multimap	$\frac{\Gamma \vdash A \quad \Upsilon_1, B, \Upsilon_2 \vdash C}{\Upsilon_1, \Gamma, A \multimap B, \Upsilon_2 \vdash C}$
Right \multimap	$\frac{A, \Gamma \vdash B}{\Gamma \vdash A \multimap B}$
Left 1	$\frac{\Upsilon_1, \Upsilon_2 \vdash A}{\Upsilon_1, 1, \Upsilon_2 \vdash A}$
Right 1	$\frac{}{\vdash 1}$
Promotion	$\frac{!\Gamma \vdash A}{!\Gamma \vdash !A}$
Dereliction	$\frac{\Upsilon_1, A, \Upsilon_2 \vdash B}{\Upsilon_1, !A, \Upsilon_2 \vdash B}$
Weakening	$\frac{\Upsilon_1, \Upsilon_2 \vdash B}{\Upsilon_1, !A, \Upsilon_2 \vdash B}$
Contraction	$\frac{\Upsilon_1, !A, !A, \Upsilon_2 \vdash B}{\Upsilon_1, !A, \Upsilon_2 \vdash B}$
Exchange	$\frac{\Upsilon_1, A_1, A_2, \Upsilon_2 \vdash B}{\Upsilon_1, A_2, A_1, \Upsilon_2 \vdash B}$

Figure 2: Sequent calculus of intuitionistic linear logic (ILL)

3.4.2 Commuting conversion cut vs. cut (second case)

Another commuting conversion is this one. The proof

Left $\&_1$	$\frac{\Upsilon_1, A, \Upsilon_2 \vdash C}{\Upsilon_1, A \& B, \Upsilon_2 \vdash C}$
Left $\&_2$	$\frac{\Upsilon_1, B, \Upsilon_2 \vdash C}{\Upsilon_1, A \& B, \Upsilon_2 \vdash C}$
Right $\&$	$\frac{\Gamma \vdash A \quad \Gamma \vdash B}{\Gamma \vdash A \& B}$
True	$\overline{\Gamma \vdash \top}$

Figure 3: Addendum to figure 2: ILL with finite products

$$\frac{\frac{\frac{\pi_1}{\vdots}}{\Gamma \vdash A} \quad \frac{\frac{\pi_2}{\vdots}}{\Delta \vdash B} \quad \frac{\pi_3}{\Upsilon_1, A, \Upsilon_2, B, \Upsilon_3 \vdash C}}{\Upsilon_1, A, \Upsilon_2, \Delta, \Upsilon_3 \vdash C} \text{Cut}}{\Upsilon_1, \Gamma, \Upsilon_2, \Delta, \Upsilon_3 \vdash C} \text{Cut}$$

is transformed into the proof

$$\frac{\frac{\frac{\pi_2}{\vdots}}{\Delta \vdash B} \quad \frac{\frac{\pi_1}{\vdots}}{\Gamma \vdash A} \quad \frac{\pi_3}{\Upsilon_1, A, \Upsilon_2, B, \Upsilon_3 \vdash C}}{\Upsilon_1, \Gamma, \Upsilon_2, B, \Upsilon_3 \vdash C} \text{Cut}}{\Upsilon_1, \Gamma, \Upsilon_2, \Delta, \Upsilon_3 \vdash C} \text{Cut}$$

and conversely.

3.5 Cut-elimination: the η -expansion steps

3.5.1 The tensor product

The proof

$$\overline{A \otimes B \vdash A \otimes B} \text{ Axiom}$$

is transformed into the proof

$$\frac{\frac{\overline{A \vdash A} \text{ Axiom} \quad \overline{B \vdash B} \text{ Axiom}}{\overline{A, B \vdash A \otimes B} \text{ Right } \otimes}}{\overline{A \otimes B \vdash A \otimes B} \text{ Left } \otimes}$$

3.5.2 The linear implication

The proof

$$\frac{}{A \multimap B \vdash A \multimap B} \text{Axiom}$$

is transformed into the proof

$$\frac{\frac{}{A \vdash A} \text{Axiom} \quad \frac{}{B \vdash B} \text{Axiom}}{A, A \multimap B \vdash B} \text{Left } \multimap} \frac{}{A \multimap B \vdash A \multimap B} \text{Right } \multimap$$

3.5.3 The tensor unit

The proof

$$\frac{}{1 \vdash 1} \text{Axiom}$$

is transformed into the proof

$$\frac{}{1 \vdash 1} \text{Left 1} \quad \frac{}{1 \vdash 1} \text{Right 1}$$

3.5.4 The exponential modality

The proof

$$\frac{}{!A \vdash !A} \text{Axiom}$$

is transformed into the proof

$$\frac{\frac{}{A \vdash A} \text{Axiom}}{!A \vdash A} \text{Dereliction} \quad \frac{}{!A \vdash !A} \text{Promotion}$$

3.6 Cut-elimination: the axiom steps

3.6.1 Axiom steps

The proof

$$\frac{\frac{}{A \vdash A} \text{Axiom} \quad \frac{\pi \vdots}{\Upsilon_1, A, \Upsilon_2 \vdash B}}{\Upsilon_1, A, \Upsilon_2 \vdash B} \text{Cut}$$

is transformed into the proof

$$\frac{\pi \vdots}{\Upsilon_1, A, \Upsilon_2 \vdash B}$$

3.6.2 Conclusion vs. axiom

The proof

$$\frac{\frac{\pi}{\vdots}}{\Gamma \vdash A} \quad \frac{}{A \vdash A} \text{Axiom}}{\Gamma \vdash A} \text{Cut}$$

is transformed into the proof

$$\frac{\pi}{\vdots}}{\Gamma \vdash A}$$

3.7 Cut-elimination: the exchange steps

3.7.1 Conclusion vs. exchange (the first case)

The proof

$$\frac{\frac{\pi_1}{\vdots}}{\Gamma \vdash A} \quad \frac{\frac{\pi_2}{\vdots}}{\Upsilon_1, A, B, \Upsilon_2 \vdash C} \text{Exchange}}{\Upsilon_1, B, \Gamma, \Upsilon_2 \vdash C} \text{Cut}$$

is transformed into the proof

$$\frac{\frac{\pi_1}{\vdots}}{\Gamma \vdash A} \quad \frac{\frac{\pi_2}{\vdots}}{\Upsilon_1, A, B, \Upsilon_2 \vdash C} \text{Cut}}{\Upsilon_1, \Gamma, B, \Upsilon_2 \vdash C} \text{Series of Exchanges}}{\Upsilon_1, B, \Gamma, \Upsilon_2 \vdash C}$$

3.7.2 Conclusion vs. exchange (the second case)

The proof

$$\frac{\frac{\pi_1}{\vdots}}{\Gamma \vdash B} \quad \frac{\frac{\pi_2}{\vdots}}{\Upsilon_1, A, B, \Upsilon_2 \vdash C} \text{Exchange}}{\Upsilon_1, \Gamma, A, \Upsilon_2 \vdash C} \text{Cut}}$$

is transformed into the proof

$$\frac{\frac{\pi_1}{\vdots} \quad \frac{\pi_2}{\vdots}}{\Gamma \vdash B \quad \Upsilon_1, A, B, \Upsilon_2 \vdash C} \text{Cut} \quad \frac{\Upsilon_1, A, \Gamma, \Upsilon_2 \vdash C}{\Upsilon_1, \Gamma, A, \Upsilon_2 \vdash C} \text{Series of Exchanges}$$

3.8 Cut-elimination: principal formula vs. principal formula

In this section and in the companion Section 3.9, we explain how the cut-elimination procedure transforms a proof

$$\frac{\frac{\pi_1}{\vdots} \quad \frac{\pi_2}{\vdots}}{\Gamma \vdash A \quad \Upsilon_1, A, \Upsilon_2 \vdash B} \text{Cut} \quad \frac{\Upsilon_1, \Gamma, \Upsilon_2 \vdash B}{\Upsilon_1, \Gamma, \Upsilon_2 \vdash B} \text{Cut}$$

in which the conclusion A and the hypothesis A are both *principal* in their respective proofs π_1 and π_2 . In this section, we treat the specific cases in which the last rules of the proofs π_1 and π_2 introduce:

- the tensor product (Section 3.8.1),
- the linear implication (Section 3.8.2),
- the tensor unit (Section 3.8.3).

For clarity's sake, we treat separately in the next section – Section 3.9 – the three cases where the last rule of the proof π_1 is a promotion rule, and the last rule of the proof π_2 is a “structural rule”: a dereliction, a weakening or a contraction.

3.8.1 The tensor product

The proof

$$\frac{\frac{\frac{\pi_1}{\vdots} \quad \frac{\pi_2}{\vdots}}{\Gamma \vdash A \quad \Delta \vdash B} \text{Right } \otimes \quad \frac{\frac{\pi_3}{\vdots}}{\Upsilon_1, A, B, \Upsilon_2 \vdash C} \text{Left } \otimes}{\frac{\Gamma, \Delta \vdash A \otimes B}{\Upsilon_1, \Gamma, \Delta, \Upsilon_2 \vdash C} \text{Cut}} \text{Cut}$$

is transformed into the proof

$$\frac{\frac{\frac{\pi_1}{\vdots}}{\Gamma \vdash A} \quad \frac{\frac{\pi_2}{\vdots}}{\Delta \vdash B} \quad \frac{\frac{\pi_3}{\vdots}}{\Upsilon_1, A, B, \Upsilon_2 \vdash C}}{\frac{\Upsilon_1, A, \Delta, \Upsilon_2 \vdash C}{\Upsilon_1, \Gamma, \Delta, \Upsilon_2 \vdash C} \text{Cut}} \text{Cut}$$

A choice has been made here, since the cut rule on the formula $A \otimes B$ is replaced by a cut rule on the formula B , followed by a cut rule on the formula A . Instead, the cut rule on A may have been applied before the cut rule on B . However, this choice is innocuous, because the two derivations resulting from this choice are equivalent – modulo the conversion rule given in Section 3.4.2.

3.8.2 The linear implication

The proof

$$\frac{\frac{\frac{\pi_1}{\vdots}}{A, \Delta \vdash B} \text{ Right } \multimap \quad \frac{\frac{\pi_2}{\vdots}}{\Gamma \vdash A} \quad \frac{\frac{\pi_3}{\vdots}}{\Upsilon_1, B, \Upsilon_2 \vdash C}}{\frac{\Upsilon_1, \Gamma, \Delta, \Upsilon_2 \vdash C}{\Delta \vdash A \multimap B} \quad \frac{\Upsilon_1, \Gamma, A \multimap B, \Upsilon_2 \vdash C}}{\Upsilon_1, \Gamma, \Delta, \Upsilon_2 \vdash C} \text{ Left } \multimap} \text{ Cut}$$

is transformed into the proof

$$\frac{\frac{\frac{\pi_2}{\vdots}}{\Gamma \vdash A} \quad \frac{\frac{\pi_1}{\vdots}}{A, \Delta \vdash B} \text{ Cut} \quad \frac{\frac{\pi_3}{\vdots}}{\Upsilon_1, B, \Upsilon_2 \vdash C} \text{ Cut}}{\frac{\Gamma, \Delta \vdash B}{\Upsilon_1, \Gamma, \Delta, \Upsilon_2 \vdash C} \text{ Cut}}$$

3.8.3 The tensor unit

The proof

$$\frac{\frac{\frac{\vdash 1}{\vdash 1} \text{ Right } 1 \quad \frac{\frac{\pi}{\vdots}}{\Upsilon_1, \Upsilon_2 \vdash A} \text{ Left } 1}}{\frac{\Upsilon_1, \Upsilon_2 \vdash A}{\Upsilon_1, 1, \Upsilon_2 \vdash A} \text{ Cut}}$$

is transformed into the proof

$$\frac{\pi}{\vdots}}{\Upsilon_1, \Upsilon_2 \vdash A}$$

3.9 Cut-elimination: promotion vs. dereliction and structural rules

In this section, we carry on and complete the task of Section 3.8: we explain how the cut-elimination procedure transforms a proof

$$\frac{\frac{\frac{\pi_1}{\vdots}}{\Gamma \vdash A} \text{Promotion} \quad \frac{\frac{\pi_2}{\vdots}}{\Upsilon_1, !A, \Upsilon_2 \vdash B} \text{Cut}}{\Upsilon_1, !\Gamma, \Upsilon_2 \vdash B}$$

in which the hypothesis $!A$ is principal in the proof π_2 . There are exactly three cases to treat, depending on the last rule of the proof π_2 :

- a dereliction (Section 3.9.1),
- a weakening (Section 3.9.2),
- a contraction (Section 3.9.3).

The interaction with an exchange step has already been treated in Section 3.7.

3.9.1 Promotion vs. dereliction

The proof

$$\frac{\frac{\frac{\pi_1}{\vdots}}{\Gamma \vdash A} \text{Promotion} \quad \frac{\frac{\pi_2}{\vdots}}{\Upsilon_1, A, \Upsilon_2 \vdash B} \text{Dereliction}}{\Upsilon_1, !\Gamma, \Upsilon_2 \vdash B} \text{Cut}$$

is transformed into the proof

$$\frac{\frac{\frac{\pi_1}{\vdots}}{\Gamma \vdash A} \quad \frac{\frac{\pi_2}{\vdots}}{\Upsilon_1, A, \Upsilon_2 \vdash B}}{\Upsilon_1, !\Gamma, \Upsilon_2 \vdash B} \text{Cut}$$

3.9.2 Promotion vs. weakening

The proof

$$\frac{\frac{\frac{\pi_1}{\vdots}}{\Gamma \vdash A} \text{Promotion} \quad \frac{\frac{\pi_2}{\vdots}}{\Upsilon_1, \Upsilon_2 \vdash B} \text{Weakening}}{\Upsilon_1, !\Gamma, \Upsilon_2 \vdash B} \text{Cut}$$

is transformed into the proof

$$\frac{\frac{\frac{\pi_2}{\vdots}}{\Upsilon_1, \Upsilon_2 \vdash B}}{\Upsilon_1, !\Gamma, \Upsilon_2 \vdash B} \text{Series of Weakenings}$$

3.9.3 Promotion vs. contraction

The proof

$$\frac{\frac{\frac{\pi_1}{\vdots}}{\Gamma \vdash A} \text{Promotion} \quad \frac{\frac{\pi_2}{\vdots}}{\Upsilon_1, !A, \Upsilon_2 \vdash B} \text{Contraction}}{\Upsilon_1, !\Gamma, \Upsilon_2 \vdash B} \text{Cut}$$

is transformed into the proof

$$\frac{\frac{\frac{\pi_1}{\vdots}}{\Gamma \vdash A} \text{Promotion} \quad \frac{\frac{\frac{\pi_1}{\vdots}}{\Gamma \vdash A} \text{Promotion} \quad \frac{\frac{\pi_2}{\vdots}}{\Upsilon_1, !A, \Upsilon_2 \vdash B} \text{Cut}}{\Upsilon_1, !\Gamma, \Upsilon_2 \vdash B} \text{Cut}}{\Upsilon_1, !\Gamma, \Upsilon_2 \vdash B} \text{Series of Contractions and Exchanges}$$

3.10 Cut-elimination: secondary conclusion

In this section, we explain how the cut-elimination procedure transforms a proof

$$\frac{\frac{\frac{\pi_1}{\vdots}}{\Gamma \vdash A} \quad \frac{\frac{\pi_2}{\vdots}}{\Upsilon_1, A, \Upsilon_2 \vdash B}}{\Upsilon_1, \Gamma, \Upsilon_2 \vdash B} \text{Cut}$$

in which the conclusion A is *secondary* in the proof π_1 . This leads us to a case analysis, where we describe how the proof evolves depending on the last rule of the proof π_1 . The six cases are treated in turn:

- a left introduction of the linear implication,
- a dereliction,
- a weakening,
- a contraction,
- an exchange,
- a left introduction of the tensor product (with low priority)
- a left introduction of the tensor unit (with low priority).

The last two cases are treated at the end of the section because they are given a lower priority in the procedure.

3.10.1 Left introduction of the linear implication

The proof

$$\frac{\frac{\frac{\pi_1}{\vdots}}{\Gamma \vdash A} \quad \frac{\frac{\pi_2}{\vdots}}{\Upsilon_2, B, \Upsilon_3 \vdash C} \text{Left } \multimap \quad \frac{\frac{\pi_3}{\vdots}}{\Upsilon_1, C, \Upsilon_4 \vdash D}}{\Upsilon_1, \Upsilon_2, \Gamma, A \multimap B, \Upsilon_3, \Upsilon_4 \vdash D} \text{Cut}$$

is transformed into the proof

$$\frac{\frac{\frac{\pi_1}{\vdots}}{\Gamma \vdash A} \quad \frac{\frac{\frac{\pi_2}{\vdots}}{\Upsilon_2, B, \Upsilon_3 \vdash C} \quad \frac{\frac{\pi_3}{\vdots}}{\Upsilon_1, C, \Upsilon_4 \vdash D}}{\Upsilon_1, \Upsilon_2, B, \Upsilon_3, \Upsilon_4 \vdash D} \text{Cut}}{\Upsilon_1, \Upsilon_2, \Gamma, A \multimap B, \Upsilon_3, \Upsilon_4 \vdash D} \text{Left } \multimap$$

3.10.2 A generic description of the structural rules: dereliction, weakening, contraction, exchange

Four cases remain to be treated in order to describe entirely how the cut-elimination procedure transforms a proof

$$\frac{\frac{\frac{\pi_1}{\vdots}}{\Gamma \vdash A} \quad \frac{\frac{\pi_2}{\vdots}}{\Upsilon_1, A, \Upsilon_4 \vdash B}}{\Upsilon_1, \Gamma, \Upsilon_4 \vdash B} \text{Cut}$$

in which the conclusion A is *secondary* in the proof π_1 . Each case depends on the last rule of the proof π_1 , which may be:

- a dereliction,
- a weakening,
- a contraction,
- an exchange.

Each of the four rules is of the form

$$\frac{\Upsilon_2, \Phi, \Upsilon_3 \vdash A}{\Upsilon_2, \Psi, \Upsilon_3 \vdash A}$$

where the context Φ is transformed into the context Ψ in a way depending on the specific rule:

- dereliction: the context Φ consists of a formula C , and the context Ψ consists of the formula $!C$,

- weakening: the context Φ is empty, and the context Ψ consists of a formula $!C$,
- contraction: the context Φ consists of two formulas $!C, !C$ and the context Ψ consists of the formula $!C$,
- exchange: the context Φ consists of two formulas C, D and the context Ψ consists of the two formulas D, C .

By hypothesis, the proof π_1 decomposes in the following way:

$$\frac{\begin{array}{c} \pi_3 \\ \vdots \end{array}}{\frac{\Upsilon_2, \Phi, \Upsilon_3 \vdash A}{\Upsilon_2, \Psi, \Upsilon_3 \vdash A}} \text{ the specific rule}$$

The proof

$$\frac{\frac{\begin{array}{c} \pi_3 \\ \vdots \end{array}}{\frac{\Upsilon_2, \Phi, \Upsilon_3 \vdash A}{\Upsilon_2, \Psi, \Upsilon_3 \vdash A}} \text{ the specific rule} \quad \frac{\begin{array}{c} \pi_2 \\ \vdots \end{array}}{\Upsilon_1, A, \Upsilon_4 \vdash B}}{\Upsilon_1, \Upsilon_2, \Psi, \Upsilon_3, \Upsilon_4 \vdash B} \text{ Cut}$$

is then transformed into the proof

$$\frac{\frac{\begin{array}{c} \pi_3 \\ \vdots \end{array}}{\Upsilon_2, \Phi, \Upsilon_3 \vdash A} \quad \frac{\begin{array}{c} \pi_2 \\ \vdots \end{array}}{\Upsilon_1, A, \Upsilon_4 \vdash B}}{\frac{\Upsilon_1, \Upsilon_2, \Phi, \Upsilon_3, \Upsilon_4 \vdash B}{\Upsilon_1, \Upsilon_2, \Psi, \Upsilon_3, \Upsilon_4 \vdash B}} \text{ Cut the specific rule}$$

3.10.3 Left introduction of the tensor (with low priority)

The proof

$$\frac{\frac{\begin{array}{c} \pi_1 \\ \vdots \end{array}}{\frac{\Upsilon_2, A, B, \Upsilon_3 \vdash C}{\Upsilon_2, A \otimes B, \Upsilon_3 \vdash C}} \text{ Left } \otimes \quad \frac{\begin{array}{c} \pi_2 \\ \vdots \end{array}}{\Upsilon_1, C, \Upsilon_4 \vdash D}}{\Upsilon_1, \Upsilon_2, A \otimes B, \Upsilon_3, \Upsilon_4 \vdash D} \text{ Cut}$$

is transformed into the proof

$$\frac{\frac{\begin{array}{c} \pi_1 \\ \vdots \end{array}}{\Upsilon_2, A, B, \Upsilon_3 \vdash C} \quad \frac{\begin{array}{c} \pi_2 \\ \vdots \end{array}}{\Upsilon_1, C, \Upsilon_4 \vdash D}}{\frac{\Upsilon_1, \Upsilon_2, A, B, \Upsilon_3, \Upsilon_4 \vdash D}{\Upsilon_1, \Upsilon_2, A \otimes B, \Upsilon_3, \Upsilon_4 \vdash D}} \text{ Cut Left } \otimes$$

Note that this coincides with the transformation described in Section 3.10.2 for the contexts $\Phi = A, B$ and $\Psi = A \otimes B$.

3.10.4 Left introduction of the tensor unit (with low priority)

The proof

$$\frac{\frac{\frac{\pi_1}{\vdots}}{\Upsilon_2, \Upsilon_3 \vdash A} \text{Left 1} \quad \frac{\frac{\pi_2}{\vdots}}{\Upsilon_1, A, \Upsilon_4 \vdash B}}{\Upsilon_1, \Upsilon_2, 1, \Upsilon_3, \Upsilon_4 \vdash B} \text{Cut}$$

is transformed into the proof

$$\frac{\frac{\frac{\pi_1}{\vdots}}{\Upsilon_2, \Upsilon_3 \vdash A} \quad \frac{\frac{\pi_2}{\vdots}}{\Upsilon_1, A, \Upsilon_4 \vdash B}}{\Upsilon_1, \Upsilon_2, \Upsilon_3, \Upsilon_4 \vdash B} \text{Cut}}{\Upsilon_1, \Upsilon_2, 1, \Upsilon_3, \Upsilon_4 \vdash B} \text{Left 1}$$

Note that this coincides with the transformation described in Section 3.10.2 for an empty context Φ , and $\Psi = 1$.

3.11 Cut-elimination: secondary hypothesis

In this section, we explain how the cut-elimination procedure transforms a proof

$$\frac{\frac{\frac{\pi_1}{\vdots}}{\Gamma \vdash A} \quad \frac{\frac{\pi_2}{\vdots}}{\Upsilon_1, A, \Upsilon_2 \vdash B}}{\Upsilon_1, \Gamma, \Upsilon_2 \vdash B} \text{Cut}$$

in which the hypothesis A is *secondary* in the proof π_2 . This leads us to a long case analysis, in which we describe how the proof evolves depending on the last rule of the proof π_2 . The nine cases are treated in turn in the section:

- the right introduction of the tensor,
- the left introduction of the linear implication,
- the four structural rules: dereliction, weakening, contraction, exchange,
- the left introduction of the tensor (with low priority),
- the left introduction of the tensor unit (with low priority),
- the right introduction of the linear implication (with low priority).

The last three cases are treated at the end of the section, because they are given a low priority in the procedure.

3.11.1 Right introduction of the tensor (first case)

The proof

$$\frac{\frac{\frac{\pi_1}{\vdots}}{\Gamma \vdash A} \quad \frac{\frac{\pi_2}{\vdots}}{\Upsilon_1, A, \Upsilon_2 \vdash B} \quad \frac{\pi_3}{\vdots}}{\Upsilon_1, A, \Upsilon_2, \Delta \vdash B \otimes C} \text{Right } \otimes}{\Upsilon_1, \Gamma, \Upsilon_2, \Delta \vdash B \otimes C} \text{Cut}$$

is transformed into the proof

$$\frac{\frac{\frac{\pi_1}{\vdots}}{\Gamma \vdash A} \quad \frac{\pi_2}{\vdots}}{\Upsilon_1, \Gamma, \Upsilon_2 \vdash B} \text{Cut} \quad \frac{\pi_3}{\vdots}}{\Delta \vdash C} \text{Right } \otimes}{\Upsilon_1, \Gamma, \Upsilon_2, \Delta \vdash B \otimes C}$$

3.11.2 Right introduction of the tensor (second case)

The proof

$$\frac{\frac{\frac{\pi_1}{\vdots}}{\Gamma \vdash A} \quad \frac{\pi_2}{\vdots}}{\Delta \vdash B} \quad \frac{\pi_3}{\vdots}}{\Upsilon_1, A, \Upsilon_2 \vdash C} \text{Right } \otimes}{\Delta, \Upsilon_1, \Gamma, \Upsilon_2 \vdash B \otimes C} \text{Cut}$$

is transformed into the proof

$$\frac{\frac{\pi_2}{\vdots}}{\Delta \vdash B} \quad \frac{\frac{\pi_1}{\vdots}}{\Gamma \vdash A} \quad \frac{\pi_3}{\vdots}}{\Upsilon_1, A, \Upsilon_2 \vdash C} \text{Cut}}{\Delta, \Upsilon_1, \Gamma, \Upsilon_2 \vdash B \otimes C} \text{Right } \otimes$$

3.11.3 Left introduction of the linear implication (first case)

The proof

$$\frac{\frac{\frac{\pi_1}{\vdots}}{\Gamma \vdash A} \quad \frac{\pi_2}{\vdots}}{\Upsilon_2, A, \Upsilon_3 \vdash B} \quad \frac{\pi_3}{\vdots}}{\Upsilon_1, C, \Upsilon_4 \vdash D} \text{Left } \multimap}{\Upsilon_1, \Upsilon_2, \Gamma, \Upsilon_3, B \multimap C, \Upsilon_4 \vdash D} \text{Cut}$$

is transformed into the proof

$$\frac{\frac{\pi_1}{\vdots} \quad \frac{\pi_2}{\vdots}}{\Gamma \vdash A} \quad \frac{\pi_3}{\vdots}}{\frac{\Upsilon_2, A, \Upsilon_3 \vdash B}{\Upsilon_2, \Gamma, \Upsilon_3 \vdash B} \text{Cut} \quad \frac{\Upsilon_1, C, \Upsilon_4 \vdash D}{\Upsilon_1, \Upsilon_2, \Gamma, \Upsilon_3, B \multimap C, \Upsilon_4 \vdash D} \text{Left } \multimap}$$

3.11.4 Left introduction of the linear implication (second case)

The proof

$$\frac{\frac{\pi_1}{\vdots} \quad \frac{\pi_2}{\vdots} \quad \frac{\pi_3}{\vdots}}{\Gamma \vdash A} \quad \frac{\frac{\Upsilon_3 \vdash B}{\Upsilon_1, A, \Upsilon_2, \Upsilon_3, B \multimap C, \Upsilon_4 \vdash D} \text{Left } \multimap} \text{Cut}}{\frac{\Upsilon_1, \Gamma, \Upsilon_2, \Upsilon_3, B \multimap C, \Upsilon_4 \vdash D}$$

is transformed into the proof

$$\frac{\frac{\pi_2}{\vdots} \quad \frac{\pi_1}{\vdots} \quad \frac{\pi_3}{\vdots}}{\Upsilon_3 \vdash B} \quad \frac{\frac{\Gamma \vdash A}{\Upsilon_1, \Gamma, \Upsilon_2, C, \Upsilon_4 \vdash D} \text{Left } \multimap} \text{Cut}}{\frac{\Upsilon_1, \Gamma, \Upsilon_2, \Upsilon_3, B \multimap C, \Upsilon_4 \vdash D}$$

3.11.5 Left introduction of the linear implication (third case)

The proof

$$\frac{\frac{\pi_1}{\vdots} \quad \frac{\pi_2}{\vdots} \quad \frac{\pi_3}{\vdots}}{\Gamma \vdash A} \quad \frac{\frac{\Upsilon_2 \vdash B}{\Upsilon_1, \Upsilon_2, B \multimap C, \Upsilon_3, A, \Upsilon_4 \vdash D} \text{Left } \multimap} \text{Cut}}{\frac{\Upsilon_1, \Upsilon_2, B \multimap C, \Upsilon_3, \Gamma, \Upsilon_4 \vdash D}$$

is transformed into the proof

$$\frac{\frac{\pi_2}{\vdots} \quad \frac{\pi_1}{\vdots} \quad \frac{\pi_3}{\vdots}}{\Upsilon_2 \vdash B} \quad \frac{\frac{\Gamma \vdash A}{\Upsilon_1, C, \Upsilon_3, A, \Upsilon_4 \vdash D} \text{Left } \multimap} \text{Cut}}{\frac{\Upsilon_1, \Upsilon_2, B \multimap C, \Upsilon_3, \Gamma, \Upsilon_4 \vdash D}$$

3.11.6 A generic description of the structural rules: dereliction, weakening, contraction, exchange

Four cases remain to be treated in order to describe how the cut-elimination procedure transforms a proof

$$\frac{\frac{\pi_1}{\vdots} \quad \frac{\pi_2}{\vdots}}{\frac{\Gamma \vdash A \quad \Upsilon_1, A, \Upsilon_2 \vdash B}{\Upsilon_1, \Gamma, \Upsilon_2 \vdash B} \text{Cut}}$$

in which the hypothesis A is *secondary* in the proof π_2 . Each case depends on the last rule of the proof π_2 , which may be:

- a dereliction,
- a weakening,
- a contraction,
- an exchange.

Each of the four rules is of the form

$$\frac{\Upsilon_1, \Phi, \Upsilon_2 \vdash B}{\Upsilon_1, \Psi, \Upsilon_2 \vdash B}$$

where the context Φ is transformed into the context Ψ in a way depending on the specific rule:

- dereliction: the context Φ consists of a formula C , and the context Ψ consists of the formula $!C$,
- weakening: the context Φ is empty, and the context Ψ consists of a formula $!C$,
- contraction: the context Φ consists of two formulas $!C, !C$ and the context Ψ consists of the formula $!C$,
- exchange: the context Φ consists of two formulas C, D and the context Ψ consists of the two formulas D, C .

From this follows that the proof π_2 decomposes as a proof of the form

$$\frac{\frac{\pi_3}{\vdots}}{\frac{\Upsilon_1, A, \Upsilon_2, \Phi, \Upsilon_3 \vdash C}{\Upsilon_1, A, \Upsilon_2, \Psi, \Upsilon_3 \vdash C} \text{the specific rule}}$$

or as a proof of the form

$$\frac{\frac{\pi_3}{\vdots}}{\frac{\Upsilon_1, \Phi, \Upsilon_2, A, \Upsilon_3 \vdash C}{\Upsilon_1, \Psi, \Upsilon_2, A, \Upsilon_3 \vdash C} \text{the specific rule}}$$

depending on the relative position of the secondary hypothesis A and of the contexts Φ and Ψ among the hypothesis of the proof π_2 . In the first case, the proof

$$\frac{\frac{\pi_1}{\vdots} \quad \frac{\frac{\pi_3}{\vdots}}{\Upsilon_1, A, \Upsilon_2, \Phi, \Upsilon_3 \vdash B} \text{ the specific rule}}{\Gamma \vdash A \quad \frac{\Upsilon_1, A, \Upsilon_2, \Psi, \Upsilon_3 \vdash B}{\Upsilon_1, \Gamma, \Upsilon_2, \Psi, \Upsilon_3 \vdash B} \text{ Cut}} \text{ Cut}$$

is transformed into the proof

$$\frac{\frac{\pi_1}{\vdots} \quad \frac{\frac{\pi_3}{\vdots}}{\Upsilon_1, A, \Upsilon_2, \Phi, \Upsilon_3 \vdash B} \text{ Cut}}{\frac{\Upsilon_1, \Gamma, \Upsilon_2, \Phi, \Upsilon_3 \vdash B}{\Upsilon_1, \Gamma, \Upsilon_2, \Psi, \Upsilon_3 \vdash B} \text{ the specific rule}} \text{ Cut}$$

In the second case, the proof

$$\frac{\frac{\pi_1}{\vdots} \quad \frac{\frac{\pi_3}{\vdots}}{\Upsilon_1, \Phi, \Upsilon_2, A, \Upsilon_3 \vdash B} \text{ the specific rule}}{\Gamma \vdash A \quad \frac{\Upsilon_1, \Psi, \Upsilon_2, A, \Upsilon_3 \vdash B}{\Upsilon_1, \Psi, \Upsilon_2, \Gamma, \Upsilon_3 \vdash B} \text{ Cut}} \text{ Cut}$$

is transformed into the proof

$$\frac{\frac{\pi_1}{\vdots} \quad \frac{\frac{\pi_3}{\vdots}}{\Upsilon_1, \Phi, \Upsilon_2, A, \Upsilon_3 \vdash B} \text{ Cut}}{\frac{\Upsilon_1, \Phi, \Upsilon_2, \Gamma, \Upsilon_3 \vdash B}{\Upsilon_1, \Psi, \Upsilon_2, \Gamma, \Upsilon_3 \vdash B} \text{ the specific rule}} \text{ Cut}$$

3.11.7 Left introduction of the tensor (first case) (with low priority)

The proof

$$\frac{\frac{\pi_1}{\vdots} \quad \frac{\frac{\pi_2}{\vdots}}{\Upsilon_1, A, \Upsilon_2, B, C, \Upsilon_3 \vdash D} \text{ Left } \otimes}}{\Gamma \vdash A \quad \frac{\Upsilon_1, A, \Upsilon_2, B \otimes C, \Upsilon_3 \vdash D}{\Upsilon_1, \Gamma, \Upsilon_2, B \otimes C, \Upsilon_3 \vdash D} \text{ Cut}} \text{ Cut}$$

is transformed into the proof

$$\frac{\frac{\pi_1}{\vdots} \quad \frac{\frac{\pi_2}{\vdots}}{\Upsilon_1, A, \Upsilon_2, B, C, \Upsilon_3 \vdash D} \text{ Cut}}{\frac{\Upsilon_1, \Gamma, \Upsilon_2, B, C, \Upsilon_3 \vdash D}{\Upsilon_1, \Gamma, \Upsilon_2, B \otimes C, \Upsilon_3 \vdash D} \text{ Left } \otimes}} \text{ Cut}$$

Note that this coincides with the transformation described in Section 3.11.6 for the contexts $\Phi = A, B$ and $\Psi = A \otimes B$.

3.11.8 Left introduction of the tensor (second case) (with low priority)

The proof

$$\frac{\frac{\pi_1}{\vdots} \quad \frac{\frac{\pi_2}{\vdots}}{\frac{\Upsilon_1, A, B, \Upsilon_2, C, \Upsilon_3 \vdash D}{\Upsilon_1, A \otimes B, \Upsilon_2, C, \Upsilon_3 \vdash D}}{\Upsilon_1, A \otimes B, \Upsilon_2, \Gamma, \Upsilon_3 \vdash D} \text{Left } \otimes}{\Gamma \vdash C} \text{Cut}$$

is transformed into the proof

$$\frac{\frac{\pi_1}{\vdots} \quad \frac{\pi_2}{\vdots}}{\frac{\Upsilon_1, A, B, \Upsilon_2, C, \Upsilon_3 \vdash D}{\Upsilon_1, A, B, \Upsilon_2, \Gamma, \Upsilon_3 \vdash D}} \text{Cut} \quad \frac{\Upsilon_1, A, B, \Upsilon_2, \Gamma, \Upsilon_3 \vdash D}{\Upsilon_1, A \otimes B, \Upsilon_2, \Gamma, \Upsilon_3 \vdash D} \text{Left } \otimes$$

Note that this coincides with the second transformation described in Section 3.11.6 for the contexts $\Phi = A, B$ and $\Psi = A \otimes B$.

3.11.9 Left introduction of the tensor unit (with low priority)

The proof

$$\frac{\frac{\pi_1}{\vdots} \quad \frac{\frac{\pi_2}{\vdots}}{\frac{\Upsilon_1, A, \Upsilon_2, \Upsilon_3 \vdash D}{\Upsilon_1, A, \Upsilon_2, 1, \Upsilon_3 \vdash D}}{\Upsilon_1, \Gamma, \Upsilon_2, 1, \Upsilon_3 \vdash D} \text{Left } 1}{\Gamma \vdash A} \text{Cut}$$

is transformed into the proof

$$\frac{\frac{\pi_1}{\vdots} \quad \frac{\pi_2}{\vdots}}{\frac{\Upsilon_1, A, \Upsilon_2, \Upsilon_3 \vdash D}{\Upsilon_1, \Gamma, \Upsilon_2, \Upsilon_3 \vdash D}} \text{Cut} \quad \frac{\Upsilon_1, \Gamma, \Upsilon_2, \Upsilon_3 \vdash D}{\Upsilon_1, \Gamma, \Upsilon_2, 1, \Upsilon_3 \vdash D} \text{Left } 1$$

Similarly, the proof

$$\frac{\frac{\pi_1}{\vdots} \quad \frac{\frac{\pi_2}{\vdots}}{\frac{\Upsilon_1, \Upsilon_2, A, \Upsilon_3 \vdash D}{\Upsilon_1, 1, \Upsilon_2, A, \Upsilon_3 \vdash D}}{\Upsilon_1, 1, \Upsilon_2, \Gamma, \Upsilon_3 \vdash D} \text{Left } 1}{\Gamma \vdash A} \text{Cut}$$

is transformed into the proof

$$\frac{\frac{\frac{\pi_1}{\vdots}}{\Gamma \vdash A} \quad \frac{\frac{\pi_2}{\vdots}}{\Upsilon_1, \Upsilon_2, A, \Upsilon_3 \vdash D}}{\Upsilon_1, \Upsilon_2, \Gamma, \Upsilon_3 \vdash D} \text{Cut}}{\Upsilon_1, \Gamma, \Upsilon_2, \Gamma, \Upsilon_3 \vdash D} \text{Left 1}$$

Note that this coincides with the two transformations described in Section 3.11.6 for the empty context Φ and the context $\Psi = 1$.

3.11.10 Right introduction of the linear implication (with low priority)

The proof

$$\frac{\frac{\frac{\pi_1}{\vdots}}{\Gamma \vdash A} \quad \frac{\frac{\pi_2}{\vdots}}{B, \Upsilon_1, A, \Upsilon_2 \vdash C}}{\Upsilon_1, A, \Upsilon_2 \vdash B \multimap C} \text{Right } \multimap}}{\Upsilon_1, \Gamma, \Upsilon_2 \vdash B \multimap C} \text{Cut}$$

is transformed into the proof

$$\frac{\frac{\frac{\pi_1}{\vdots}}{\Gamma \vdash A} \quad \frac{\frac{\pi_2}{\vdots}}{B, \Upsilon_1, A, \Upsilon_2 \vdash C}}{B, \Upsilon_1, \Gamma, \Upsilon_2 \vdash C} \text{Cut}}{\Upsilon_1, \Gamma, \Upsilon_2 \vdash B \multimap C} \text{Right } \multimap}$$

3.12 Discussion

Let us briefly come back to the core of the discussion of Sections 2.4 and 2.5 concerning the structure of a category of proof invariants. We show that such a category is monoidal when one relaxes the priorities assigned to the various transformation steps in the cut-elimination procedure. The proof

$$\frac{\frac{\frac{\pi_1}{\vdots}}{\Gamma, C, D \vdash A}}{\Gamma, C \otimes D \vdash A} \text{Left } \otimes \quad \frac{\frac{\pi_2}{\vdots}}{\Delta \vdash B}}{\Delta \vdash B} \text{Right } \otimes}{\Gamma, C \otimes D, \Delta \vdash A \otimes B} \text{Right } \otimes} \quad (30)$$

may be cut against the identity proof

$$\frac{\frac{\frac{A \vdash A}{\text{Axiom}} \quad \frac{B \vdash B}{\text{Axiom}}}{A, B \vdash A \otimes B} \text{Right } \otimes}{A \otimes B \vdash A \otimes B} \text{Left } \otimes}$$

this resulting in the proof

$$\frac{\frac{\frac{\pi_1}{\vdots} \quad \frac{\Gamma, C, D \vdash A}{\Gamma, C \otimes D \vdash A} \text{Left } \otimes}{\Gamma, C \otimes D, \Delta \vdash A \otimes B} \quad \frac{\frac{\pi_2}{\vdots} \quad \frac{\Delta \vdash B}{\Delta \vdash B} \text{Right } \otimes}{\Gamma, C \otimes D, \Delta \vdash A \otimes B} \quad \frac{\frac{\frac{\overline{A \vdash A} \text{Axiom} \quad \frac{\overline{B \vdash B} \text{Axiom}}{A, B \vdash A \otimes B} \text{Right } \otimes}{A \otimes B \vdash A \otimes B} \text{Left } \otimes}{\Gamma, C \otimes D, \Delta \vdash A \otimes B} \text{Cut}}{\Gamma, C \otimes D, \Delta \vdash A \otimes B} \text{Cut}$$

The compositionality requirement on the category of invariants ensures that this proof has the same denotation as the original proof (30). Now, the cut-elimination step described in Section 3.8.1 rewrites the proof into

$$\frac{\frac{\frac{\pi_1}{\vdots} \quad \frac{\Gamma, C, D \vdash A}{\Gamma, C \otimes D \vdash A} \text{Left } \otimes}{\Gamma, C \otimes D, \Delta \vdash A \otimes B} \quad \frac{\frac{\frac{\pi_2}{\vdots} \quad \frac{\overline{A \vdash A} \text{Axiom} \quad \frac{\overline{B \vdash B} \text{Axiom}}{A, B \vdash A \otimes B} \text{Right } \otimes}{A, \Delta \vdash A \otimes B} \text{Cut}}{A, \Delta \vdash A \otimes B} \text{Cut}}{\Gamma, C \otimes D, \Delta \vdash A \otimes B} \text{Cut}$$

which is itself transformed by the step described in Section 3.11.2 which permutes the cut rule and the right introduction of the tensor product, this leading to the proof

$$\frac{\frac{\frac{\pi_1}{\vdots} \quad \frac{\Gamma, C, D \vdash A}{\Gamma, C \otimes D \vdash A} \text{Left } \otimes}{\Gamma, C \otimes D, \Delta \vdash A \otimes B} \quad \frac{\frac{\overline{A \vdash A} \text{Axiom} \quad \frac{\frac{\frac{\pi_2}{\vdots} \quad \frac{\overline{\Delta \vdash B} \quad \frac{\overline{B \vdash B} \text{Axiom}}{\Delta \vdash B} \text{Cut}}{\Delta \vdash B} \text{Right } \otimes}{A, \Delta \vdash A \otimes B} \text{Cut}}{A, \Delta \vdash A \otimes B} \text{Cut}}{\Gamma, C \otimes D, \Delta \vdash A \otimes B} \text{Cut}}{\Gamma, C \otimes D, \Delta \vdash A \otimes B} \text{Cut}$$

Now, the cut rule and the axiom rule disappear thanks to the cut-elimination step described in Section 3.6.2

$$\frac{\frac{\frac{\pi_1}{\vdots} \quad \frac{\Gamma, C, D \vdash A}{\Gamma, C \otimes D \vdash A} \text{Left } \otimes}{\Gamma, C \otimes D, \Delta \vdash A \otimes B} \quad \frac{\frac{\overline{A \vdash A} \text{Axiom} \quad \frac{\overline{\Delta \vdash B} \text{Right } \otimes}{\Delta \vdash B} \text{Right } \otimes}{A, \Delta \vdash A \otimes B} \text{Cut}}{\Gamma, C \otimes D, \Delta \vdash A \otimes B} \text{Cut} \quad (31)$$

Then, the cut rule and the left introduction of the tensor are permuted by the cut-elimination step described in Section 3.10.3. Note that this rewriting step is not permitted by our original priority policy: the step described in Section 3.11.1 permuting the cut rule and the right introduction of the tensor should be performed first. Hence, this transformation from (31) to (32) is only

Similarly, the rule of Section 3.9.3 which describes how promotion interacts with contraction becomes, once restated classically, the rule which transforms the proof

$$\frac{\frac{\frac{\pi_1}{\vdots}}{\frac{\vdash ?\Gamma, A}{\vdash ?\Gamma, !A}} \text{Promotion} \quad \frac{\frac{\frac{\pi_2}{\vdots}}{\frac{\vdash ?A^\perp, ?A^\perp, \Delta}{\vdash ?A^\perp, \Delta}}{\vdash ?A^\perp, \Delta} \text{Contraction}}{\vdash \Gamma, \Delta} \text{Cut}}$$

into the proof

$$\frac{\frac{\frac{\pi_1}{\vdots}}{\frac{\vdash ?\Gamma, A}{\vdash ?\Gamma, !A}} \text{Promotion} \quad \frac{\frac{\frac{\frac{\pi_1}{\vdots}}{\frac{\vdash ?\Gamma, A}{\vdash ?\Gamma, !A}} \text{Promotion} \quad \frac{\frac{\frac{\pi_2}{\vdots}}{\frac{\vdash ?A^\perp, ?A^\perp, \Delta}{\vdash ?A^\perp, \Delta}}{\vdash ?\Gamma, ?A^\perp, \Delta}}{\vdash ?\Gamma, ?A^\perp, \Delta} \text{Cut}}{\frac{\vdash ?\Gamma, ?\Gamma, \Delta}{\vdash ?\Gamma, \Delta} \text{Contraction}} \text{Cut}}$$

Adapting in this way all the cut-elimination rules of intuitionistic linear logic presented in Sections 3.4 – 3.11, one obtains a legitimate cut-elimination procedure for classical linear logic.

4 Monoidal categories and duality

After recalling the definition of a monoidal category, as well as the string diagram notation, we describe two alternative ways to define duality and the notion of $*$ -autonomous category (read star-autonomous). On the one hand, a $*$ -autonomous category may be seen as a symmetric monoidal closed category equipped with a dualizing object. This is developed in Sections 4.1—4.8 according to the topography below.

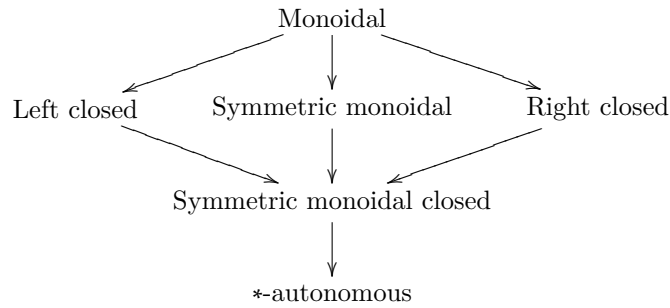

On the other hand, a $*$ -autonomous category may also be seen as a symmetric linearly distributive category equipped with a duality. The notion of linearly distributive category and its connection to $*$ -autonomous categories is developed in Sections 4.9—4.13 following the topography below.

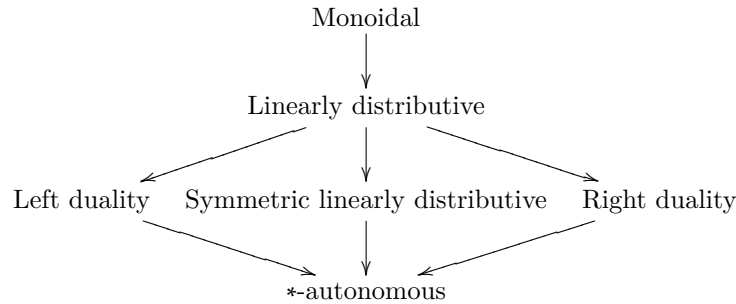

Alternatively, a $*$ -autonomous category may be seen as a dialogue category whose negation is involutive. This point is developed in Sections 4.14—4.15 where the notion of dialogue category is introduced.

4.1 Monoidal categories

A monoidal category is a category \mathbf{C} equipped with a bifunctor

$$\otimes : \mathbf{C} \times \mathbf{C} \longrightarrow \mathbf{C}$$

associative up to a natural isomorphism

$$\alpha_{A,B,C} : (A \otimes B) \otimes C \longrightarrow A \otimes (B \otimes C)$$

and with an object e unit up to natural isomorphisms

$$\lambda_A : e \otimes A \longrightarrow A, \quad \rho_A : A \otimes e \longrightarrow A.$$

The structure maps α, λ, ρ must satisfy two axioms. First, the pentagonal diagram

$$\begin{array}{ccc} & (A \otimes B) \otimes (C \otimes D) & \\ \alpha \nearrow & & \searrow \alpha \\ ((A \otimes B) \otimes C) \otimes D & & A \otimes (B \otimes (C \otimes D)) \\ \alpha \otimes D \downarrow & & \uparrow A \otimes \alpha \\ (A \otimes (B \otimes C)) \otimes D & \xrightarrow{\alpha} & A \otimes ((B \otimes C) \otimes D) \end{array}$$

should commute for all objects A, B, C, D of the category. Second, the triangular diagram

$$\begin{array}{ccc} (A \otimes e) \otimes B & \xrightarrow{\alpha} & A \otimes (e \otimes B) \\ \rho \otimes B \searrow & & \swarrow A \otimes \lambda \\ & A \otimes B & \end{array}$$

should commute for all objects A and B of the category. Note that for clarity's sake, we generally drop the indices on the structure maps α, λ, ρ in our diagrams, and write A instead of id_A in compound morphisms like $A \otimes \alpha = id_A \otimes \alpha$.

The pentagon and triangle axioms ensure that every diagram made of structure maps commutes in the category \mathbf{C} . This property is called the *coherence property* of monoidal categories. It implies among other things that the structure morphisms $\lambda_e : e \otimes e \longrightarrow e$ and $\rho_e : e \otimes e \longrightarrow e$ coincide. This point is worth stressing, since the equality of these two maps is often given as a third axiom of monoidal categories. The equality follows in fact from the pentagon and triangle axioms. We clarify this point in Proposition 2, after the preliminary Proposition 1.

Proposition 1 *The triangles*

$$\begin{array}{ccc} (e \otimes A) \otimes B & \xrightarrow{\alpha} & e \otimes (A \otimes B) \\ \lambda \otimes B \searrow & & \swarrow \lambda \\ & A \otimes B & \end{array}$$

and

$$\begin{array}{ccc} (A \otimes B) \otimes e & \xrightarrow{\alpha} & A \otimes (B \otimes e) \\ \rho \searrow & & \swarrow A \otimes \rho \\ & A \otimes B & \end{array}$$

commute in any monoidal category \mathbf{C} .

Proof. The proof is based on the observation that the functor $e \otimes - : \mathbf{C} \rightarrow \mathbf{C}$ is full and faithful, because λ is a natural isomorphism from this functor to the identity functor. So, two morphisms $f, g : A \rightarrow B$ coincide if and only if the morphisms $e \otimes f, e \otimes g : e \otimes A \rightarrow e \otimes B$ coincide as well. In particular, the first triangle of the proposition commutes if and only if the triangle

$$\begin{array}{ccc}
 e \otimes ((e \otimes A) \otimes B) & \xrightarrow{e \otimes \alpha} & e \otimes (e \otimes (A \otimes B)) \\
 & \searrow^{e \otimes (\lambda \otimes B)} & \swarrow_{e \otimes \lambda} \\
 & e \otimes (A \otimes B) &
 \end{array}$$

commutes. Now, this triangle commutes if and only if the triangle obtained by adjoining a pentagon on top of it

$$\begin{array}{ccc}
 ((e \otimes e) \otimes A) \otimes B & \xrightarrow{\alpha} & (e \otimes e) \otimes (A \otimes B) \\
 \alpha \otimes B \downarrow & & \downarrow \alpha \\
 (e \otimes (e \otimes A)) \otimes B & & \\
 \alpha \downarrow & & \\
 e \otimes ((e \otimes A) \otimes B) & \xrightarrow{\dots e \otimes \alpha \dots} & e \otimes (e \otimes (A \otimes B)) \\
 & \searrow^{e \otimes (\lambda \otimes B)} & \swarrow_{e \otimes \lambda} \\
 & e \otimes (A \otimes B) &
 \end{array}$$

commutes as well — this comes from the fact that α is an isomorphism. We leave as an exercise to the reader the elementary “diagram-chase” proving that this last triangle commutes, with its two borders equal to:

$$((e \otimes e) \otimes A) \otimes B \xrightarrow{(\rho \otimes A) \otimes B} (e \otimes A) \otimes B \xrightarrow{\alpha} e \otimes (A \otimes B).$$

This establishes that the first triangle of the proposition commutes. The second triangle is shown to commute in a similar way. \square

Proposition 2 *The two morphisms λ_e and ρ_e coincide in any monoidal category \mathbf{C} .*

Proof. Naturality of λ implies that the diagram

$$\begin{array}{ccc}
 e \otimes (e \otimes B) & \xrightarrow{\lambda} & e \otimes B \\
 e \otimes \lambda \downarrow & & \downarrow \lambda \\
 e \otimes B & \xrightarrow{\lambda} & B
 \end{array}$$

commutes. From this follows that the two structure morphisms

$$e \otimes (e \otimes B) \xrightarrow{\lambda} e \otimes B \qquad e \otimes (e \otimes B) \xrightarrow{e \otimes \lambda} e \otimes B$$

coincide — because the morphism $\lambda : e \otimes B \rightarrow B$ is an isomorphism. This is the crux of the proof. Then, one instantiates the object A by the unit object e in the first triangle of Proposition 1, and replaces the morphism λ by the morphism $e \otimes \lambda$, to obtain that the triangle

$$\begin{array}{ccc} (e \otimes e) \otimes B & \xrightarrow{\alpha} & e \otimes (e \otimes B) \\ \lambda \otimes B \downarrow & & \downarrow e \otimes \lambda \\ e \otimes B & = & e \otimes B \end{array}$$

commutes for every object B of the category \mathbf{C} . The triangular axiom of monoidal categories indicates then that the two morphisms:

$$(e \otimes e) \otimes B \xrightarrow{\lambda_e \otimes B} e \otimes B \qquad (e \otimes e) \otimes B \xrightarrow{\rho_e \otimes B} e \otimes B$$

coincide for every object B , and in particular for the object $B = e$. This shows that the two morphisms $\lambda_e \otimes e$ and $\rho_e \otimes e$ coincide. Just as in the proof of Proposition 1, we conclude from the fact that the functor $- \otimes e : \mathbf{C} \rightarrow \mathbf{C}$ is full and faithful: the two morphisms λ_e and ρ_e coincide. \square

One is generally interested in combining objects A_1, \dots, A_n of a monoidal category \mathbf{C} using the “monoidal structure” or “tensor product” of the category, in order to obtain an object like $\bigotimes_i A_i$. Unfortunately, the tensor product is only associative up to natural isomorphism. Thus, there are generally several candidates for $\bigotimes_i A_i$. Typically, $(A_1 \otimes A_2) \otimes A_3$ and $A_1 \otimes (A_2 \otimes A_3)$ are two isomorphic objects of the category, candidates for the tensor product of A_1, A_2, A_3 . This is the reason why the coherence property is so useful: it enables us to “identify” the various candidates for $\bigotimes_i A_i$ in a *coherent* way. One may thus proceed “as if” the isomorphisms α, λ, ρ were identities.

This aspect of coherence is important. It may be expressed in a quite elegant and conceptual way. A monoidal category is *strict* when its structure maps α, λ and ρ are identities. So, in a strict monoidal category, there is only *one* candidate for $\bigotimes_i A_i$. The coherence theorem states that every monoidal category is *equivalent* to a strict monoidal category. Equivalence of monoidal categories is expressed conveniently in the 2-category of monoidal categories, monoidal functors, and monoidal natural transformations. We come back to this point, and provide all definitions, in Chapter 5.

Exercise. Show that in every monoidal category \mathbf{C} , the set of endomorphisms of the unit object e defines a *commutative* monoid for the composition, in the sense that $f \circ g = g \circ f$ for every two morphisms $f, g : e \rightarrow e$. Show moreover that composition coincides with tensor product up to the isomorphism $\rho_e = \lambda_e$, in the sense that $f \otimes g = \rho_e^{-1} \circ (f \circ g) \circ \rho_e$. \blacksquare

4.2 String diagrams

String diagrams provide a pleasant topological account of morphisms in monoidal categories. The idea is to depict a morphism $f : A \otimes B \otimes C \rightarrow D \otimes E$ of the monoidal category as

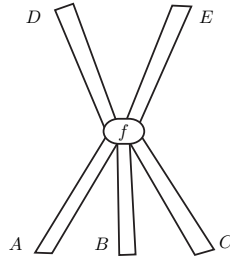

The composite $g \circ f : A \rightarrow C$ of two morphisms $f : A \rightarrow B$ and $g : B \rightarrow C$ is then depicted as:

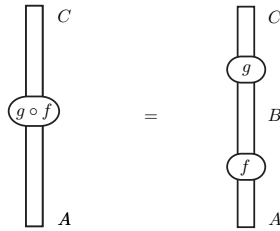

and the tensor product $f \otimes g : A \otimes C \rightarrow B \otimes D$ of two morphisms $f : A \rightarrow B$ and $g : C \rightarrow D$ as:

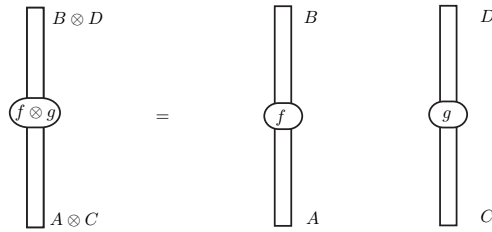

Observe that composition and tensor product are depicted as *vertical* and *horizontal* composition in string diagrams, respectively.

The interested reader will find more on the topic in [55, 56, 86]. See also [73] for an introduction to the topic in the context of linear logic.

4.3 Braided monoidal categories

A braided monoidal category is a monoidal category \mathbf{C} equipped with a braiding. A braiding is a natural isomorphism

$$\gamma_{A,B} : A \otimes B \rightarrow B \otimes A$$

making the hexagonal diagrams

$$\begin{array}{ccccc}
 & \alpha & \rightarrow & A \otimes (B \otimes C) & \xrightarrow{\gamma} & (B \otimes C) \otimes A & \xrightarrow{\alpha} & B \otimes (C \otimes A) \\
 & & & \searrow & & \nearrow & & \\
 (A \otimes B) \otimes C & & & & & & & \\
 & \xrightarrow{\gamma \otimes C} & & (B \otimes A) \otimes C & \xrightarrow{\alpha} & B \otimes (A \otimes C) & \xrightarrow{B \otimes \gamma} & B \otimes (C \otimes A)
 \end{array}$$

and

$$\begin{array}{ccccc}
 & \alpha^{-1} & \rightarrow & (A \otimes B) \otimes C & \xrightarrow{\gamma} & C \otimes (A \otimes B) & \xrightarrow{\alpha^{-1}} & (C \otimes A) \otimes B \\
 & & & \searrow & & \nearrow & & \\
 A \otimes (B \otimes C) & & & & & & & \\
 & \xrightarrow{A \otimes \gamma} & & A \otimes (C \otimes B) & \xrightarrow{\alpha^{-1}} & (A \otimes C) \otimes B & \xrightarrow{\gamma \otimes B} & (C \otimes A) \otimes B
 \end{array}$$

commute. Here, we should mention that the name “braiding” comes from the topological account offered by string diagrams. Typically, the first hexagonal coherence diagram is depicted as the equality

$$\begin{array}{ccc}
 \begin{array}{c} B \quad C \quad A \\ \text{[Diagram 1]} \\ A \quad B \quad C \end{array} & = & \begin{array}{c} B \quad C \quad A \\ \text{[Diagram 2]} \\ A \quad B \quad C \end{array} \quad (34)
 \end{array}$$

whereas the second hexagonal coherence diagram is depicted as the equality

$$\begin{array}{ccc}
 \begin{array}{c} C \quad A \quad B \\ \text{[Diagram 3]} \\ A \quad B \quad C \end{array} & = & \begin{array}{c} C \quad A \quad B \\ \text{[Diagram 4]} \\ A \quad B \quad C \end{array}
 \end{array}$$

Here, the diagrams should be read from bottom to top, each positive braid permutation corresponding to a morphism γ . One advantage of the pictorial notation is that the associativity morphisms are not indicated.

Note that the second hexagon is just the first one in which the morphism γ has been replaced by its inverse γ^{-1} . Diagrammatically speaking, this amounts

to the fact that the second pictorial equality reads upside down (that is, from top to bottom) as the first pictorial equality (34) where every positive braid permutation γ has been replaced by its inverse γ^{-1} , the negative braid permutation:

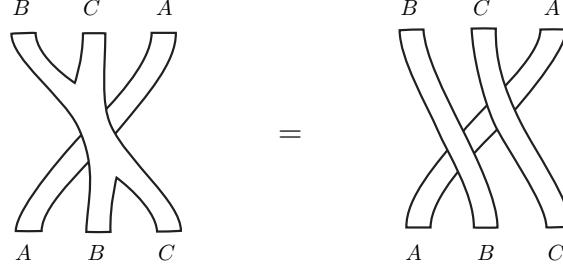

The braiding and the unit of the monoidal category are related in the following way.

Proposition 3 *The triangles*

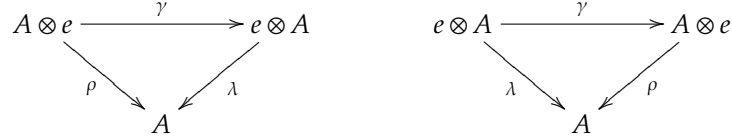

commute in any braided monoidal category \mathbf{C} .

Proof. The idea is to fill the first commutative hexagon with five smaller commutative diagrams:

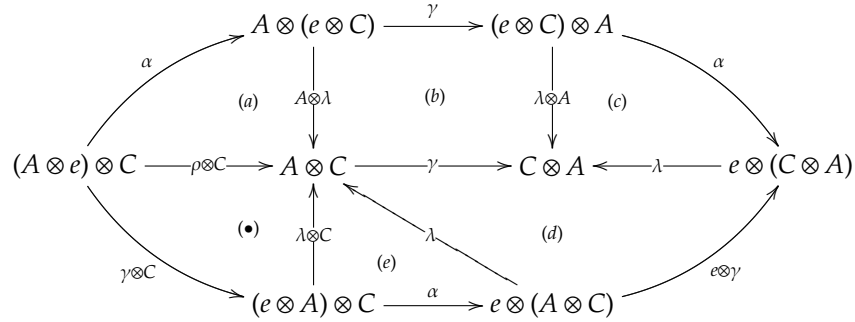

In clockwise order, these diagrams commute (a) by the triangle axiom of monoidal categories, (b) by naturality of γ , (c) by Proposition 1, (d) by naturality of λ , (e) by Proposition 1. From this and the fact that γ is an isomorphism, follows that diagram (•) commutes.

Now, one instantiates diagram (•) with $C = e$. Just as in the proofs of Proposition 1 and 2, one uses the fact that the functor $- \otimes e : \mathbf{C} \rightarrow \mathbf{C}$ is full and faithful, in order to deduce that the first triangle of the proposition commutes. The second triangle of the proposition is shown to commute in a similar way. \square

4.4 Symmetric monoidal categories

A symmetric monoidal category \mathbf{C} is a braided monoidal category whose braiding is a symmetry. A symmetry is a braiding satisfying $\gamma_{B,A} = \gamma_{A,B}^{-1}$ for all objects A, B of the category. Note that, in that case, the second hexagonal diagram may be dropped in the definition of braiding, since this diagram commutes for $\gamma_{A,B}$ if and only if the first hexagonal diagram commutes for $\gamma_{B,A} = \gamma_{A,B}^{-1}$.

4.5 Monoidal closed categories

A *left closed structure* in a monoidal category (\mathbf{C}, \otimes, e) is the data of

- an object $A \multimap B$,
- a morphism $eval_{A,B} : A \otimes (A \multimap B) \rightarrow B$,

for every two objects A and B of the category \mathbf{C} . The morphism $eval_{A,B}$ is called the *left evaluation* morphism. It must satisfy the following universal property. For every morphism

$$f : A \otimes X \rightarrow B$$

there exists a unique morphism

$$h : X \rightarrow A \multimap B$$

making the diagram

$$\begin{array}{ccc} A \otimes X & & \\ \downarrow A \otimes h & \searrow f & \\ A \otimes (A \multimap B) & \xrightarrow{eval_{A,B}} & B \end{array} \quad (35)$$

commute.

A monoidal closed category \mathbf{C} is a monoidal category equipped with a left closed structure. There are several alternative definitions of a closed structure, which we review here.

It follows from the universality property (35) that every object A of the category \mathbf{C} defines an endofunctor

$$B \mapsto (A \multimap B) \quad (36)$$

of the category \mathbf{C} . Besides, for every object A , this functor is right adjoint to the functor

$$B \mapsto (A \otimes B). \quad (37)$$

This means that there exists a bijection between the sets of morphisms

$$\mathbf{C}(A \otimes B, C) \cong \mathbf{C}(B, A \multimap C) \quad (38)$$

natural in B and C . This provides an alternative definition of a left closed structure: a right adjoint to the functor (37), for every object A . The reader

interested in the notion of adjunction will find a comprehensive study of the notion in Chapter 5.

Then, the parameter theorem (see Theorem 3 in Chapter IV, Section 7 of MacLane's book [66]) enables us to structure the family of functors (36) indexed by objects of \mathbf{A} , as a bifunctor

$$(A, B) \mapsto A \multimap B : \mathbf{C}^{op} \times \mathbf{C} \longrightarrow \mathbf{C} \quad (39)$$

contravariant in its first argument, covariant in its second argument. This bifunctor is defined as the unique bifunctor making the bijection (38) natural in A , B and C . This provides yet another alternative definition of left closed structure: a bifunctor (39) and a bijection (38) natural in A , B and C .

Exercise. Show that in a monoidal closed category \mathbf{C} with monoidal unit e , every object A is isomorphic to the object $e \multimap A$. Show moreover that the isomorphism between A and $e \multimap A$ is natural in A . ■

4.6 Monoidal biclosed categories

A monoidal biclosed category is a monoidal category equipped with a left closed structure as well as a right closed structure. By definition, a *right closed structure* in a monoidal category (\mathbf{C}, \otimes, e) is the data of

- an object $A \multimap B$,
- a morphism $eval_{A,B} : (B \multimap A) \otimes A \longrightarrow B$,

for every two objects A and B of the category \mathbf{C} . The morphism $eval_{A,B}$ is called the *right evaluation* morphism. It must satisfy a similar universal property as the left evaluation morphism in Section 4.5, that for every morphism

$$f : X \otimes A \longrightarrow B$$

there exists a unique morphism

$$h : X \longrightarrow B \multimap A$$

making the diagram below commute:

$$\begin{array}{ccc} X \otimes A & & \\ \downarrow h \otimes A & \searrow f & \\ (B \multimap A) \otimes A & \xrightarrow{eval_{A,B}} & B \end{array} \quad (40)$$

As for the left closed structure in Section 4.5, this is equivalent to the property that the endofunctor

$$B \mapsto (B \otimes A)$$

has a right adjoint

$$B \mapsto (B \multimap A)$$

for every object A of the category. The parameter theorem ensures then that this family of functors indexed by the object A defines a bifunctor

$$\multimap : \mathbf{C} \times \mathbf{C}^{op} \longrightarrow \mathbf{C}$$

and a family of bijections

$$\mathbf{C}(B \otimes A, C) \cong \mathbf{C}(B, C \multimap A) \quad (41)$$

natural in the objects A , B and C .

4.7 Symmetric monoidal closed categories

A symmetric monoidal closed category \mathbf{C} is a monoidal category equipped with a symmetry and a left closed structure. It is not difficult to show that any symmetric monoidal closed category is also equipped with a right closed structure, defined as follows:

- the object $B \multimap A$ is defined as the object $A \multimap B$,
- the right evaluation morphism $eval_{A,B}$ is defined as

$$(A \multimap B) \otimes A \xrightarrow{\gamma_{A \multimap B, A}} A \otimes (A \multimap B) \xrightarrow{eval_{A,B}} B$$

Symmetric monoidal closed categories provide the necessary structure to interpret the formulas and proofs of the *multiplicative* and *intuitionistic* fragment of linear logic. The symmetry interprets *exchange*, the operation of permuting formulas in a sequent, while the tensor product and closed structure interpret the multiplicative conjunction and implication of the logic, respectively.

This logical perspective on categories with structure is often enlightening, both for logic and for categories. By way of illustration, there is a famous principle in intuitionistic logic that every formula A implies its double negation $\neg\neg A$. This principle holds also in intuitionistic *linear* logic. In that case, the negation of a formula A is given by the formula $A \multimap \perp$, where \perp stands for the multiplicative formula *False*. As a matter of fact, the formula *False* may be replaced by any other formula \perp for that purpose, in particular when no formula *False* is available in the logic. So, there is a proof π in intuitionistic linear logic that every formula A implies its double negation $(A \multimap \perp) \multimap \perp$, whatever the chosen formula \perp .

This fundamental principle of logic has a categorical counterpart in any monoidal *biclosed* category \mathbf{C} , and more specifically, in any symmetric monoidal closed category. Like in linear logic, any object of the category \mathbf{C} can play the role of \perp , understood intuitively as the formula *False*. One shows that there exists a morphism

$$\partial_A : A \longrightarrow \perp \multimap (A \multimap \perp)$$

for every object A of the monoidal biclosed category \mathbb{C} , and that this morphism is natural in A . This reflects the logical phenomenon in a non commutative framework: indeed, when the category \mathbb{C} is symmetric, the two objects

$$\perp \multimap (A \multimap \perp) \qquad (A \multimap \perp) \multimap \perp$$

coincide (up to isomorphism) and the map

$$\partial_A : A \longrightarrow (A \multimap \perp) \multimap \perp$$

is precisely the interpretation of the proof π that every formula A implies its double negation $(A \multimap \perp) \multimap \perp$ in intuitionistic linear logic.

The morphism ∂_A is constructed by a series of manipulations on the identity morphism:

$$id_{A \multimap \perp} : (A \multimap \perp) \longrightarrow (A \multimap \perp).$$

First, one applies the bijection (38) associated to the left closed structure, from right to left, in order to obtain the morphism:

$$A \otimes (A \multimap \perp) \longrightarrow \perp \tag{42}$$

Then, one applies the bijection (41) associated to the right closed structure, from left to right, in order to obtain the morphism:

$$\partial_A : A \longrightarrow \perp \multimap (A \multimap \perp).$$

When the category \mathbb{C} is symmetric monoidal closed, the morphism ∂_A is alternatively constructed by pre-composing the morphism (42) with the symmetry

$$\gamma_{A, A \multimap \perp} : (A \multimap \perp) \otimes A \longrightarrow A \otimes (A \multimap \perp)$$

so as to obtain the morphism

$$(A \multimap \perp) \otimes A \longrightarrow \perp.$$

then the bijection (38) from left to right:

$$\partial_A : A \longrightarrow (A \multimap \perp) \multimap \perp.$$

Exercise. For every object \perp of a monoidal biclosed category \mathbb{C} , construct a morphism

$$\bar{\partial}_A : A \longrightarrow (\perp \multimap A) \multimap \perp.$$

Show that the two morphisms ∂_A and $\bar{\partial}_A$ are natural in A . ■

4.8 *-autonomous categories

A *-autonomous category is a monoidal biclosed category \mathbf{C} equipped with a dualizing object. A dualizing object \perp is an object of the category such that the two morphisms

$$\partial_A : A \longrightarrow \perp \circlearrowleft (A \multimap \perp) \qquad \bar{\partial}_A : A \longrightarrow (\perp \circlearrowleft A) \multimap \perp$$

constructed in Section 4.7 are isomorphisms, for every object A of the category. From now on, we will only consider in this survey the situation when the monoidal biclosed category \mathbf{C} is in fact symmetric monoidal closed. In that case, an object \perp is dualizing precisely when the canonical morphism

$$\partial_A : A \longrightarrow (A \multimap \perp) \multimap \perp$$

is an isomorphism for every object A of the category.

This notion of dualizing object may be given a logical flavor. There is a governing principle in classical logic that the disjunction of a formula A and of its negation $\neg A$ is necessarily true. This principle of *Tertium non Datur* is supported by the idea that a formula is either true or false. Interestingly, this principle of classical logic may be formulated alternatively as the property that every formula A is equivalent to its double negation $\neg\neg A$. This principle does not hold in intuitionistic logic: a formula A implies its double negation $\neg\neg A$ intuitionistically, but the converse is not necessarily true.

On the other hand, the existence of a dualizing object \perp in a symmetric monoidal closed category enables an interpretation of *classical* multiplicative linear logic and its involutive negation, instead of just *intuitionistic* multiplicative linear logic. Typically, the multiplicative disjunction $A \wp B$ is defined as follows:

$$A \wp B = ((A \multimap \perp) \otimes (B \multimap \perp)) \multimap \perp. \quad (43)$$

Exercise. Show that the object $\perp \multimap \perp$ is isomorphic to the unit object e in any *-autonomous category. ■

Exercise. Show that the multiplicative disjunction $A \wp B$ induces a monoidal structure (\mathbf{C}, \wp, \perp) in any symmetric monoidal closed category \mathbf{C} with dualizing object \perp . ■

4.9 Linearly distributive categories

A linearly distributive category \mathbf{C} is a monoidal category twice: once for the bifunctor $\otimes : \mathbf{C} \times \mathbf{C} \longrightarrow \mathbf{C}$ with unit e and natural isomorphisms

$$\begin{aligned} \alpha_{A,B,C}^{\otimes} &: (A \otimes B) \otimes C \longrightarrow A \otimes (B \otimes C), \\ \lambda_A^{\otimes} &: e \otimes A \longrightarrow A, \qquad \rho_A^{\otimes} : A \otimes e \longrightarrow A, \end{aligned}$$

and again for the bifunctor $\bullet : \mathbb{C} \times \mathbb{C} \longrightarrow \mathbb{C}$ with unit u and natural isomorphisms

$$\begin{aligned} \alpha_{A,B,C}^\bullet &: (A \bullet B) \bullet C \longrightarrow A \bullet (B \bullet C), \\ \lambda_A^\bullet &: u \bullet A \longrightarrow A, \quad \rho_A^\bullet : A \bullet u \longrightarrow A. \end{aligned}$$

In order to distinguish them, the operations \otimes and \bullet are called ‘‘tensor product’’ and ‘‘cotensor product’’ respectively. The tensor product is required to distribute over the cotensor product by natural morphisms

$$\begin{aligned} \delta_{A,B,C}^L &: A \otimes (B \bullet C) \longrightarrow (A \otimes B) \bullet C, \\ \delta_{A,B,C}^R &: (A \bullet B) \otimes C \longrightarrow A \bullet (B \otimes C). \end{aligned}$$

These structure maps must satisfy a series of commutativity axioms: six pentagons and four triangles, which we review below.

The pentagons relate the distributions δ^L and δ^R to the associativity laws, and to themselves. We were careful to draw these pentagons in a uniform way. This presentation emphasizes the fact that the distributions are (lax) *associativity laws* between the tensor and the cotensor products. Consequently, each of the pentagonal diagram below is a variant of the usual pentagonal diagram for monoidal categories. Note that there are exactly $2^3 = 8$ different ways to combine four objects A, B, C, D by a tensor and a cotensor product. The two extremal cases (only tensors, only cotensors) are treated by the requirement that the tensor and cotensor products define monoidal categories. Each of the six remaining cases is treated by one pentagon below.

$$\begin{array}{ccc} & (A \bullet B) \otimes (C \otimes D) & \\ \alpha^\otimes \nearrow & & \searrow \delta^R \\ ((A \bullet B) \otimes C) \otimes D & & A \bullet (B \otimes (C \otimes D)) \\ \delta^R \otimes D \downarrow & & \uparrow A \bullet \alpha^\otimes \\ (A \bullet (B \otimes C)) \otimes D & \xrightarrow{\delta^R} & A \bullet ((B \otimes C) \otimes D) \end{array}$$

$$\begin{array}{ccc} & (A \bullet B) \bullet (C \otimes D) & \\ \delta^R \nearrow & & \searrow \alpha^\bullet \\ ((A \bullet B) \bullet C) \otimes D & & A \bullet (B \bullet (C \otimes D)) \\ \alpha^\bullet \otimes D \downarrow & & \uparrow A \bullet \delta^R \\ (A \bullet (B \bullet C)) \otimes D & \xrightarrow{\delta^R} & A \bullet ((B \bullet C) \otimes D) \end{array}$$

$$\begin{array}{ccc} & (A \otimes B) \bullet (C \bullet D) & \\ \alpha^\bullet \nearrow & & \searrow \delta^L \\ (A \otimes B) \bullet C \bullet D & & A \otimes (B \bullet (C \bullet D)) \\ \delta^L \bullet D \uparrow & & \uparrow A \otimes \alpha^\bullet \\ (A \otimes (B \bullet C)) \bullet D & \xleftarrow{\delta^L} & A \otimes ((B \bullet C) \bullet D) \end{array}$$

$$\begin{array}{ccc}
& (A \otimes B) \otimes (C \bullet D) & \\
\delta^L \swarrow & & \searrow \alpha^\otimes \\
((A \otimes B) \otimes C) \bullet D & & A \otimes (B \otimes (C \bullet D)) \\
\alpha^\otimes \bullet D \downarrow & & \downarrow A \otimes \delta^L \\
(A \otimes (B \otimes C)) \bullet D & \xleftarrow{\delta^L} & A \otimes ((B \otimes C) \bullet D)
\end{array}$$

$$\begin{array}{ccc}
& (A \bullet B) \otimes (C \bullet D) & \\
\delta^L \swarrow & & \searrow \delta^R \\
((A \bullet B) \otimes C) \bullet D & & A \bullet (B \otimes (C \bullet D)) \\
\delta^R \bullet D \downarrow & & \downarrow A \bullet \delta^L \\
(A \bullet (B \otimes C)) \bullet D & \xrightarrow{\alpha^\bullet} & A \bullet ((B \otimes C) \bullet D)
\end{array}$$

$$\begin{array}{ccc}
& (A \otimes B) \bullet (C \otimes D) & \\
\delta^R \swarrow & & \searrow \delta^L \\
((A \otimes B) \bullet C) \otimes D & & A \otimes (B \bullet (C \otimes D)) \\
\delta^L \otimes D \uparrow & & \uparrow A \otimes \delta^R \\
(A \otimes (B \bullet C)) \otimes D & \xrightarrow{\alpha^\otimes} & A \otimes ((B \bullet C) \otimes D)
\end{array}$$

The triangles relate the distributions to the units. Again, each triangle is a variant of the familiar diagram in monoidal categories, analyzed in Proposition 1.

$$\begin{array}{ccc}
e \otimes (A \bullet B) \xrightarrow{\delta^L} (e \otimes A) \bullet B & (A \bullet B) \otimes e \xrightarrow{\delta^R} A \bullet (B \otimes e) \\
\lambda^\otimes \downarrow & \downarrow \lambda^\otimes \bullet B & \rho^\otimes \downarrow & \downarrow A \bullet \rho^\otimes \\
A \bullet B = A \bullet B & & A \bullet B = A \bullet B
\end{array}$$

$$\begin{array}{ccc}
A \otimes (B \bullet u) \xrightarrow{\delta^L} (A \otimes B) \bullet u & (u \bullet A) \otimes B \xrightarrow{\delta^R} u \bullet (A \otimes B) \\
A \otimes \rho^\bullet \downarrow & \downarrow \rho^\bullet & \lambda^* \otimes B \downarrow & \downarrow \lambda^* \\
A \otimes B = A \otimes B & & A \otimes B = A \otimes B
\end{array}$$

Exercise. Show that every monoidal category defines a linearly distributive category in which the tensor and cotensor products coincide. ■

4.10 Duality in linearly distributive categories

Let \mathbf{C} be a linearly distributive category, formulated with the same notations as in Section 4.9. A right duality in \mathbf{C} is the data of:

- an object A^* ,
- two morphisms $ax_A^R : e \rightarrow A^* \bullet A$ and $cut_A^R : A \otimes A^* \rightarrow u$

for every object A of the category \mathbf{C} . The morphisms are required to make the diagrams

$$\begin{array}{ccc}
A \otimes e & \xrightarrow{A \otimes ax^R} & A \otimes (A^* \bullet A) \\
\downarrow \rho^\circ & & \downarrow \delta^L \\
& & (A \otimes A^*) \bullet A \\
& & \downarrow cut^R \bullet A \\
A & \xleftarrow{\lambda^*} & u \bullet A
\end{array}
\qquad
\begin{array}{ccc}
e \otimes A^* & \xrightarrow{ax^R \otimes A^*} & (A^* \bullet A) \otimes A^* \\
\downarrow \lambda^\circ & & \downarrow \delta^R \\
& & A^* \bullet (A \otimes A^*) \\
& & \downarrow A^* \bullet cut^R \\
A^* & \xleftarrow{\rho^*} & A^* \bullet u
\end{array}$$

commute. To every morphism $f : A \rightarrow B$ in the category \mathbf{C} , one associates the morphism $f^* : B^* \rightarrow A^*$ constructed in the following way:

$$\begin{array}{ccccc}
B^* & & A^* \bullet (A \otimes B^*) & \xrightarrow{A^* \bullet (f \otimes B^*)} & A^* \bullet (B \otimes B^*) & \xrightarrow{A^* \bullet cut^R} & A^* \bullet u \\
(\lambda^\circ)^{-1} \downarrow & & \delta^R \uparrow & & \delta^R \uparrow & & \downarrow \rho^* \\
e \otimes B^* & \xrightarrow{ax^R \otimes B^*} & (A^* \bullet A) \otimes B^* & \xrightarrow{(A^* \bullet f) \otimes B^*} & (A^* \bullet B) \otimes B^* & & A^*
\end{array}$$

The coherence diagrams ensure that this operation on morphisms defines a contravariant functor

$$(A \mapsto A^*) : \mathbf{C}^{op} \rightarrow \mathbf{C}.$$

Moreover, one shows that

Proposition 4 *In any linearly distributive category \mathbf{C} with a right duality,*

- *the functor $(A \otimes -)$ is left adjoint to the functor $(A^* \bullet -)$,*
- *the functor $(- \bullet B)$ is right adjoint to the functor $(- \otimes B^*)$,*

for all objects A, B of the category. In particular, any such category is monoidal closed.

There is also a notion of left duality in a linearly distributive category \mathbf{C} , which is given by the data of:

- an object *A ,
- two morphisms $ax_A^L : e \rightarrow A \bullet {}^*A$ and $cut_A^L : {}^*A \otimes A \rightarrow u$

for every object A of the category \mathbf{C} . Just as in the case of a right duality, the morphisms are required to make the coherence diagrams

$$\begin{array}{ccc}
e \otimes A & \xrightarrow{ax^L \otimes A} & (A \bullet {}^*A) \otimes A \\
\downarrow \lambda^\circ & & \downarrow \delta^R \\
& & A \bullet ({}^*A \otimes A) \\
& & \downarrow A \bullet cut^L \\
A & \xleftarrow{\rho^*} & A \bullet u
\end{array}
\qquad
\begin{array}{ccc}
{}^*A \otimes e & \xrightarrow{{}^*A \otimes ax^L} & {}^*A \otimes (A \bullet {}^*A) \\
\downarrow \rho^\circ & & \downarrow \delta^L \\
& & ({}^*A \otimes A) \bullet {}^*A \\
& & \downarrow cut^L \bullet {}^*A \\
{}^*A & \xleftarrow{\lambda^*} & u \bullet {}^*A
\end{array}$$

commute.

Proposition 5 *In any linearly distributive category \mathbf{C} with a left duality,*

- *the functor $(- \otimes B)$ is left adjoint to the functor $(- \bullet {}^*B)$,*
- *the functor $(A \bullet -)$ is right adjoint to the functor $({}^*A \otimes -)$,*

for all objects A, B of the category.

Exercise. Show that there is a natural isomorphism between A , ${}^*(A^*)$ and $({}^*A)^*$ in any linearly distributive category with a left and right duality. Hint: show that the bijections

$$\mathbf{C}(A, B) \cong \mathbf{C}(e, A^* \bullet B) \cong \mathbf{C}({}^*(A^*), B)$$

are natural in A and B . Deduce that there exists a natural isomorphism between A and ${}^*(A^*)$. Proceed similarly to establish the existence of a natural isomorphism between A and $({}^*A)^*$. ■

Exercise. Suppose that \mathbf{C} is a linearly distributive category with a right duality. Deduce from the previous exercise, and some diagrammatic inspection, that there exists at most one left duality in the category \mathbf{C} , up to the expected notion of isomorphism between left dualities. ■

4.11 Braided linearly distributive categories

A braided linearly distributive category \mathbf{C} is a linearly distributive category in which the two monoidal structures are braided, with braidings given by natural isomorphisms:

$$\gamma_{A,B}^{\otimes} : A \otimes B \longrightarrow B \otimes A, \quad \gamma_{A,B}^{\bullet} : A \bullet B \longrightarrow B \bullet A.$$

Moreover, the braidings and the distributions should make the diagrams

$$\begin{array}{ccccc} A \otimes (B \bullet C) & \xrightarrow{A \otimes \gamma^{\bullet}} & A \otimes (C \bullet B) & \xrightarrow{\gamma^{\otimes}} & (C \bullet B) \otimes A \\ \delta^L \downarrow & & & & \downarrow \delta^R \\ (A \otimes B) \bullet C & \xrightarrow{\gamma^{\bullet}} & C \bullet (A \otimes B) & \xrightarrow{C \bullet \gamma^{\otimes}} & C \bullet (B \otimes A) \end{array} \quad (44)$$

$$\begin{array}{ccccc} (A \bullet B) \otimes C & \xrightarrow{\gamma^{\bullet \otimes C}} & (B \bullet A) \otimes C & \xrightarrow{\gamma^{\otimes}} & C \otimes (B \bullet A) \\ \delta^R \downarrow & & & & \downarrow \delta^L \\ A \bullet (B \otimes C) & \xrightarrow{\gamma^{\bullet}} & (B \otimes C) \bullet A & \xrightarrow{\gamma^{\otimes \bullet A}} & (C \otimes B) \bullet A \end{array} \quad (45)$$

commute, for all objects A, B, C .

Exercise. Show that every braided monoidal category defines a braided linearly distributive category in which the tensor and cotensor products coincide. ■

4.12 Symmetric linearly distributive categories

A symmetric linear distributive category \mathbb{C} is a braided linearly distributive category whose two braidings γ^\otimes and γ^\bullet are symmetries. Here, recall that a symmetry γ is a braiding satisfying $\gamma_{B,A} = \gamma_{A,B}^{-1}$ for all objects A, B of the category. Just as in the case of symmetries in monoidal categories, note that the second coherence diagram (44) may be dropped in the definition of braided linearly distributive category. Indeed, the diagram commutes for $\gamma_{A,B}^\otimes$ and $\gamma_{A,B}^\bullet$ if and only if the second diagram commutes for their inverse $(\gamma_{A,B}^\otimes)^{-1} = \gamma_{B,A}^\otimes$ and $(\gamma_{A,B}^\bullet)^{-1} = \gamma_{B,A}^\bullet$.

4.13 *-autonomous categories as linearly distributive categories

In a symmetric linearly distributive category, any right duality ($A \mapsto A^*$) induces a left duality ($A \mapsto {}^*A$) given by ${}^*A = A^*$ and the structure morphisms:

$$ax_A^L = \gamma_{A^*,A}^\bullet \circ ax_{A^*}^R, \quad cut_A^L = cut_A^R \circ \gamma_{A^*,A}^\otimes.$$

We have seen in Section 4.10 (last exercise) that this defines the unique left duality in the category \mathbb{C} , up to the expected notion of isomorphism between left duality. In fact, Cockett and Seely prove that this provides another formulation

Proposition 6 (Cockett-Seely) *The three notions below coincide:*

- **-autonomous categories,*
- *symmetric linearly distributive categories with a right duality,*
- *symmetric linearly distributive categories with a left duality.*

4.14 Dialogue categories

We conclude the chapter by introducing the notion of dialogue category, which generalizes the notion of *-autonomous category by relaxing the hypothesis that negation is involutive. Several definitions of dialogue category are possible. So, we find clarifying to review here four of these definitions – and to explain in which way they differ.

First definition. A dialogue category is defined as a symmetric monoidal category $(\mathbb{C}, \otimes, 1)$ equipped with an exponentiable object \perp , called the *tensorial pole* of the category. Recall that an object \perp is exponentiable when every functor

$$A \mapsto \mathbb{C}(A \otimes B, \perp) : \mathbb{C}^{op} \longrightarrow \mathbf{Cat}$$

is representable by an object $B \multimap \perp$ and a bijection

$$\phi_{A,B} : \mathbb{C}(A \otimes B, \perp) \cong \mathbb{C}(A, B \multimap \perp)$$

natural in A . A simple argument based on the Yoneda principle shows that the family of objects $B \multimap \perp$ induces (in a unique way) a functor

$$B \mapsto B \multimap \perp : \mathbf{C}^{op} \longrightarrow \mathbf{C} \quad (46)$$

such that the family $\phi_{A,B}$ is natural in A and B .

Second definition. An alternative (and essentially equivalent) definition of dialogue category is possible, where one asks of the exponentiable object \perp that every functor

$$A \mapsto \mathbf{C}(A \otimes B_1 \otimes \cdots \otimes B_n, \perp) : \mathbf{C}^{op} \longrightarrow \mathbf{Cat}$$

is representable by an object

$$B_1 \multimap \cdots \multimap B_n \multimap \perp \quad (47)$$

and a bijection

$$\phi_{A,B_1,\dots,B_n} : \mathbf{C}(A \otimes B_1 \otimes \cdots \otimes B_n, \perp) \cong \mathbf{C}(A, B_1 \multimap \cdots \multimap B_n \multimap \perp)$$

natural in A , for every sequence B_1, \dots, B_n of objects of the category \mathbf{C} . Here, the tensor product

$$A \otimes B_1 \otimes \cdots \otimes B_n := (\cdots((A \otimes B_1) \otimes B_2) \otimes \cdots \otimes B_n)$$

should be parsed as a left to right sequence of binary tensor products. This n -ary definition of tensorial pole is equivalent to the previous one, up to the choice of objects (47) for $n \geq 2$. In particular, there exists for each natural number $n \in \mathbb{N}$ a (uniquely determined) functor

$$(B_1, \dots, B_n) \mapsto B_1 \multimap \cdots \multimap B_n \multimap \perp : \overbrace{\mathbf{C}^{op} \times \cdots \times \mathbf{C}^{op}}^n \longrightarrow \mathbf{C}$$

such that the family ϕ_{A,B_1,\dots,B_n} is natural in A and B_1, \dots, B_n .

Third definition. This observation leads to an equivalent definition of dialogue category, where the notion of exponentiable object \perp is replaced by a family $(S_n)_{n \in \mathbb{N}}$ of n -ary functors, expressing negation. In this style, a dialogue category is defined as a symmetric monoidal category $(\mathbf{C}, \otimes, 1)$ equipped with a *tensorial negation* defined as a family of functors

$$S_n : \overbrace{\mathbf{C}^{op} \times \cdots \times \mathbf{C}^{op}}^n \longrightarrow \mathbf{C} \quad (48)$$

for each natural number $n \in \mathbb{N}$, equipped with a bijection

$$\psi_{A,B_1,B_2,\dots,B_n} : \mathbf{C}(A \otimes B_1, S_{n-1}(B_2, \dots, B_n)) \cong \mathbf{C}(A, S_n(B_1, B_2, \dots, B_n))$$

natural in A, B_1, \dots, B_n . This notion of tensorial negation reformulates precisely the n -ary notion of tensorial pole formulated in the second definition. On the one hand, every tensorial pole \perp defines a tensorial negation as

$$S_n(A_1, \dots, A_n) := A_1 \multimap \dots \multimap A_n \multimap \perp$$

with family of bijections defined as

$$\psi_{A, B_1, \dots, B_n} := \phi_{A, B_1, B_2, \dots, B_n} \circ \phi_{A \otimes B_1, B_2, \dots, B_n}^{-1}$$

Conversely, every tensorial negation S induces a tensorial pole $\perp = S_0$ with representing objects and bijections defined as expected:

$$A_1 \multimap \dots \multimap A_n \multimap \perp := S_n(A_1, \dots, A_n)$$

$$\phi_{A_1, \dots, A_n} := \psi_{A_1, A_2, \dots, A_{n-1}, A_n} \circ \dots \circ \psi_{A_1 \otimes \dots \otimes A_{n-2}, A_{n-1}, A_n} \circ \psi_{A_1 \otimes \dots \otimes A_{n-1}, A_n}$$

This back and forth translation induces a one-to-one relationship between the tensorial negations S and the exponentiable objects \perp with choice of representing objects (47).

Fourth definition. The n -ary definition of tensorial negation S formulated in (48) may be replaced by an unary definition, but at the price of a coherence diagram. In this alternative formulation, a tensorial negation is defined as a functor

$$\neg : \mathbf{C}^{op} \rightarrow \mathbf{C} \quad (49)$$

equipped with a bijection

$$\psi_{A, B, C} : \mathbf{C}(A \otimes B, \neg C) \cong \mathbf{C}(A, \neg(B \otimes C))$$

natural in A, B and C . One requires moreover that the coherence diagram

$$\begin{array}{ccc} \mathbf{C}(A \otimes (B \otimes C), \neg D) & \xrightarrow{\mathbf{C}(\alpha, \neg D)} & \mathbf{C}((A \otimes B) \otimes C, \neg D) \\ \downarrow \psi_{A, B \otimes C, D} & & \downarrow \psi_{A \otimes B, C, D} \\ \mathbf{C}(A, \neg((B \otimes C) \otimes D)) & \xleftarrow{\mathbf{C}(A, \neg \alpha)} & \mathbf{C}(A, \neg(B \otimes (C \otimes D))) \end{array} \quad (50)$$

commutes for all objects A, B, C and D . This single coherence axiom ensures in particular that the other expected coherence diagram

$$\begin{array}{ccc} \mathbf{C}(A \otimes 1, \neg B) & \xrightarrow{\psi_{A, 1, B}} & \mathbf{C}(A, \neg(1 \otimes B)) \\ \searrow \mathbf{C}(\rho, \neg B) & & \nearrow \mathbf{C}(A, \neg \lambda) \\ & \mathbf{C}(A, \neg B) & \end{array}$$

commutes, for all objects A and B .

At this point, it is worth explaining in what sense this definition of unary negation coincides with the definition of tensorial pole \perp in our second definition of dialogue category, or of n -ary negation S in our third definition of dialogue category, up to a straightforward notion of equivalence. On the one hand, every unary negation induces a tensorial pole \perp with representing objects defined as

$$A_1 \multimap \cdots \multimap A_n \multimap \perp \quad := \quad \neg (A_1 \otimes \cdots \otimes A_n)$$

equipped with the natural family of bijections ϕ_{A,B_1,\dots,B_n} defined as

$$\begin{array}{ccc} \mathbb{C}(A \otimes B_1 \otimes \cdots \otimes B_n, \perp) & & \mathbb{C}(A, (B \otimes C) \multimap \perp) \\ \mathbb{C}(\alpha, \perp) \downarrow & & \uparrow \mathbb{C}(A, \neg \rho^{-1}) \\ \mathbb{C}(A \otimes (B_1 \otimes \cdots \otimes B_n), \perp) & \xrightarrow{\psi_{A,B_1 \otimes \cdots \otimes B_n, 1}} & \mathbb{C}(A, \neg((B_1 \otimes \cdots \otimes B_n) \otimes 1)) \end{array}$$

where α denotes a sequence of associativity laws α and α^{-1} . Conversely, every tensorial pole \perp induces the unary negation defined as

$$\neg \quad : \quad A \quad \mapsto \quad A \multimap \perp$$

equipped with the natural family of bijections $\psi_{A,B,C}$ defined as

$$\begin{array}{ccc} \mathbb{C}(A \otimes B, C \multimap \perp) & & \mathbb{C}(A, (B \otimes C) \multimap \perp) \\ \phi_{A \otimes B, C}^{-1} \downarrow & & \uparrow \phi_{A, B \otimes C} \\ \mathbb{C}((A \otimes B) \otimes C, \perp) & \xrightarrow{\mathbb{C}(\alpha^{-1}, \perp)} & \mathbb{C}(A \otimes (B \otimes C), \perp) \end{array} \quad (51)$$

Note that it is not necessary to assume the coherence diagram (50) in order to construct the tensorial pole \perp from the tensorial negation. Consequently, every tensorial negation (without coherence) induces a tensorial negation (with coherence) by translating back the tensorial pole \perp into the language of tensorial negations. So, the coherence diagram (50) is simply here to ensure that there is no extra information in the original tensorial negation, and that the back and forth translation between (unary) negations and poles keeps the negation invariant. This implies in particular that the family of isomorphisms $\psi_{A,B,C}$ is of the particular form (51).

On the other hand, the back and forth translation preserves the tensorial poles up to a natural isomorphism

$$A_1 \multimap \cdots \multimap A_n \multimap \perp \quad \cong \quad (A_1 \otimes \cdots \otimes A_n) \multimap \perp$$

which relates the original choice of representing objects, to the choice of representing objects induced by back and forth translation.

4.15 *-autonomous as dialogue categories

The notion of dialogue category is motivated by its ubiquity: indeed, every object \perp in a symmetric monoidal closed category \mathbf{C} defines a tensorial pole, and thus a dialogue category. Another motivation comes from the deep connections with game semantics mentioned in Section 2.7 and discussed further in the concluding Chapter 9. Observe already that every tensorial negation induces an adjunction

$$\mathbf{C} \begin{array}{c} \xrightarrow{L} \\ \perp \\ \xleftarrow{R} \end{array} \mathbf{C}^{op} \quad (52)$$

between the dialogue category \mathbf{C} and its opposite category \mathbf{C}^{op} , where R coincides with the functor \neg whereas the functor L is defined as the opposite functor \neg^{op} . The adjunction simply mirrors the existence of bijections

$$\mathbf{C}(A, \neg B) \cong \mathbf{C}(B, \neg A) \cong \mathbf{C}^{op}(\neg A, B)$$

natural in A and B , obtained in the following way:

$$\mathbf{C}(A, \neg B) \xrightarrow{\phi_{A,B}^{-1}} \mathbf{C}(A \otimes B, \perp) \xrightarrow{-\circ\gamma_{B,A}} \mathbf{C}(B \otimes A, \perp) \xrightarrow{\phi_{B,A}} \mathbf{C}(B, \neg A)$$

The adjunction $L \dashv R$ induces a monad $R \circ L$ whose unit η defines the well-known family of morphisms

$$\eta_A : A \longrightarrow \neg\neg A \quad (53)$$

reflecting the logical principle that every formula A implies its double negation $\neg\neg A$. This leads to yet another formulation of *-autonomous category, based this time on dialogue categories:

Proposition 7 *The three notions below coincide:*

- **-autonomous categories,*
- *dialogue categories where the adjunction (52) is an equivalence,*
- *dialogue categories where the unit (53) is an isomorphism.*

The notion of adjunction is studied at length in the next Chapter 5. Recall here that an adjunction $L \dashv R$ is called an equivalence when its unit η and its counit ε are isomorphisms.

4.16 Notes and references

The notion of linearly distributive is introduced by Robin Cockett and Robert Seely in [26]. A coherence theorem for linearly distributive categories has been established by the two authors, in collaboration with Rick Blute and David Trimble [19]. The construction of the free linearly distributive category over a given category \mathbf{C} (or more generally, a polycategory) is described in full details.

The approach is based on the proof-net notation introduced by Jean-Yves Girard in linear logic [40]. The main difficulty is to describe properly the equality of proof-nets induced by the free linearly distributive category. An interesting conservativity result is established there: the canonical functor from a linearly distributive category to the free $*$ -autonomous category over it, is a full and faithful embedding. The notion of $*$ -autonomous category was introduced by Michael Barr, see [7]. Note that there also exists a non symmetric variant of $*$ -autonomous category, defined and studied in [8].

5 Adjunctions between monoidal categories

In this chapter as well as in its companion Chapter 7, we discuss one of the earliest and most debated questions of linear logic: what is a categorical model of linear logic? This topic is surprisingly subtle and interesting. A few months only after the introduction of linear logic, there was already a general agreement among specialists

- that the category of denotations \mathbb{L} should be symmetric monoidal closed in order to interpret intuitionistic linear logic,
- that the category \mathbb{L} should be $*$ -autonomous in order to interpret classical linear logic,
- that the category \mathbb{L} should be cartesian in order to interpret the additive connective $\&$, and cocartesian in order to interpret the additive connective \oplus .

But difficulties (and possible disagreements) arose when people started to axiomatize the categorical properties of the exponential modality “!”. These categorical properties should ensure that the category \mathbb{L} defines a modular invariant of proofs for the whole of linear logic. Several alternative definitions were formulated, each one adapted to a particular situation or philosophy: Seely categories, Lafont categories, Linear categories, etc.

Today, twenty years after the formulation of linear logic, it seems that a consensus has finally emerged between these various definitions — around the notion of *symmetric monoidal adjunction*. It appears indeed that each of the axiomatizations of the exponential modality ! implements a particular recipe to produce a symmetric monoidal adjunction between the category of denotations \mathbb{L} and a specific cartesian category \mathbb{M} , as depicted below.

$$\begin{array}{ccc}
 & \xrightarrow{(L,m)} & \\
 (\mathbb{M}, \times, e) & \perp & (\mathbb{L}, \otimes, 1) \\
 & \xleftarrow{(M,n)} &
 \end{array}$$

Our presentation in Chapter 7 of the categorical models of linear logic is thus regulated by the theory of monoidal categories, and more specifically, by the notion of symmetric monoidal adjunction. For that reason, we devote the present chapter to the elementary theory of monoidal categories and monoidal adjunctions, with an emphasis on the 2-categorical aspects of the theory:

- Sections 5.1 – 5.6: we recall the notions of lax and oplax monoidal functor, this including the symmetric case, and the notion of monoidal natural transformation between such functors,
- Section 5.7: we extend the string diagram notation with a notion of *functorial box*, enabling us to depict monoidal functors,

- Section 5.8 – 5.9: after recalling the definition of a 2-category, we construct the 2-category **LaxMonCat** with monoidal categories as objects, lax monoidal functors as horizontal morphisms, and monoidal natural transformations as vertical morphisms,
- Sections 5.10 – 5.14: the 2-categorical definition of adjunction is formulated in three different ways, and applied to the 2-category **LaxMonCat** in order to define the notion of monoidal adjunction,
- Section 5.15 – 5.16: the notion of monoidal adjunction is characterized as an adjunction $F_* \dashv F^*$ between monoidal categories, in which the left adjoint functor (F_*, m) is strong monoidal.
- Section 5.17: in this last section, we explicate the notion of *symmetric* monoidal adjunction, and characterize it as a monoidal adjunction in which the left adjoint functor (F_*, m) is strong and symmetric.

The various categorical axiomatizations of linear logic: Lafont categories, Seely categories, Linear categories, and their relationship to monoidal adjunctions, are discussed thoroughly in the companion Chapter 7.

5.1 Lax monoidal functors

A *lax monoidal functor* (F, m) between monoidal categories (\mathbb{C}, \otimes, e) and (\mathbb{D}, \bullet, u) is a functor $F : \mathbb{C} \rightarrow \mathbb{D}$ equipped with natural transformations

$$m_{A,B}^2 : FA \bullet FB \rightarrow F(A \otimes B), \quad m^0 : u \rightarrow Fe,$$

making the three diagrams

$$\begin{array}{ccc}
 (FA \bullet FB) \bullet FC & \xrightarrow{\alpha^\bullet} & FA \bullet (FB \bullet FC) \\
 \downarrow m \bullet FC & & \downarrow FA \bullet m \\
 F(A \otimes B) \bullet FC & & FA \bullet F(B \otimes C) \\
 \downarrow m & & \downarrow m \\
 F((A \otimes B) \otimes C) & \xrightarrow{F\alpha^\otimes} & F(A \otimes (B \otimes C))
 \end{array}$$

$$\begin{array}{ccc}
 FA \bullet u & \xrightarrow{\rho^\bullet} & FA \\
 \downarrow FA \bullet m & & \uparrow F\rho^\otimes \\
 FA \bullet Fe & \xrightarrow{m} & F(A \otimes e)
 \end{array}
 \quad
 \begin{array}{ccc}
 u \bullet FB & \xrightarrow{\lambda^\bullet} & FB \\
 \downarrow m \bullet FB & & \uparrow F\lambda^\otimes \\
 Fe \otimes FB & \xrightarrow{m} & F(e \otimes B)
 \end{array}$$

commute in the category \mathbb{D} for all objects A, B, C of the category \mathbb{C} .

A *strong monoidal functor* is defined as a lax monoidal functor whose mediating maps m^2 and m^0 are isomorphisms. A *strict monoidal functor* is a strong monoidal functor whose mediating maps are identities.

Remark. Our terminology is based on the idea that lax monoidal functors are lax morphisms between pseudo-algebras for a particular 2-dimensional monad in the 2-category of categories: the monad which associates to a category its free symmetric monoidal category, see for instance [62]. At the same time, we have chosen to call *strong monoidal* functor what would be probably called pseudo (or weak) monoidal functor in this philosophy.

Remark. We will encounter at the beginning of Chapter 6 one of the original motivations for the definition of lax monoidal functor, discussed by Jean Bénabou in [11]. The category $\mathbb{1}$ with one object and its identity morphism defines a monoidal category in a unique way. It appears then that a lax monoidal functor from this monoidal category $\mathbb{1}$ to a monoidal category \mathbb{C} is the same thing as a monoid in the category \mathbb{C} . As we will see in Section 6.2, this has the remarkable consequence that the structure of monoid (and of monoid morphism) is preserved by lax monoidal functors.

5.2 Oplax monoidal functors

The definition of a lax monoidal functor is based on a particular orientation of the mediating maps: from the object $FA \bullet FB$ to the object $F(A \otimes B)$, and from the object u to the object Fe . Reversing the orientation leads to another notion of “lax” monoidal functor, explicated now. An *oplax monoidal functor* (F, n) between monoidal categories (\mathbb{C}, \otimes, e) and (\mathbb{D}, \bullet, u) consists of a functor $F : \mathbb{C} \rightarrow \mathbb{D}$ and natural transformations

$$n_{A,B}^2 : F(A \otimes B) \rightarrow FA \bullet FB \quad n^0 : Fe \rightarrow u$$

making the three diagrams

$$\begin{array}{ccc}
 F((A \otimes B) \otimes C) & \xrightarrow{F\alpha^\otimes} & F(A \otimes (B \otimes C)) \\
 \downarrow n & & \downarrow n \\
 F(A \otimes B) \bullet FC & & FA \bullet F(B \otimes C) \\
 \downarrow n \bullet FC & & \downarrow FA \bullet n \\
 (FA \bullet FB) \bullet FC & \xrightarrow{\alpha^\bullet} & FA \bullet (FB \bullet FC)
 \end{array}$$

$$\begin{array}{ccc}
 F(A \otimes e) & \xrightarrow{F\rho^\otimes} & FA \\
 \downarrow n & & \uparrow \rho^\bullet \\
 FA \bullet Fe & \xrightarrow{FA \bullet n} & FA \bullet u
 \end{array}
 \quad
 \begin{array}{ccc}
 F(e \otimes B) & \xrightarrow{F\lambda^\otimes} & FB \\
 \downarrow n & & \uparrow \lambda^\bullet \\
 Fe \bullet FB & \xrightarrow{n \bullet FB} & u \bullet FB
 \end{array}$$

commute in the category \mathbb{D} , for all objects A, B, C of the category \mathbb{C} .

The notion of oplax monoidal functor is slightly less familiar than its lax counterpart. It may be justified by the following observation.

Exercise. Show that every functor $F : \mathbf{C} \rightarrow \mathbf{D}$ between cartesian categories defines an oplax monoidal functor (F, n) in a unique way. ■

The definition of oplax monoidal functor leads to an alternative definition of strong monoidal functor, defined now as an *oplax* monoidal functor whose mediating maps n^2 and n^0 are isomorphisms. We leave the reader to prove in the next exercise that this definition of strong monoidal functor is equivalent to the definition given in Section 5.1.

Exercise. Show that every oplax monoidal functor (F, n) whose mediating morphisms n^2 and n^0 are isomorphisms, defines a lax monoidal functor (F, m) with mediating morphisms $m_{A,B}^2$ and m^0 the inverse of $n_{A,B}^2$ and n^0 . ■

5.3 Natural transformations

Suppose that F and G are two functors between the same categories:

$$\mathbf{C} \rightarrow \mathbf{D}.$$

We recall that a natural transformation

$$\theta : F \Rightarrow G : \mathbf{C} \rightarrow \mathbf{D}$$

between the two functors F and G is a family θ of morphisms

$$\theta_A : FA \rightarrow GA$$

of the category \mathbf{D} indexed by the objects A of the category \mathbf{C} , making the diagram

$$\begin{array}{ccc} FA & \xrightarrow{\theta_A} & GA \\ Ff \downarrow & & \downarrow Gf \\ FB & \xrightarrow{\theta_B} & GB \end{array}$$

commute in the category \mathbf{D} , for every morphism $f : A \rightarrow B$ in the category \mathbf{C} .

5.4 Monoidal natural transformations (between lax functors)

We suppose here that (F, m) and (G, n) are lax monoidal functors between the same monoidal categories:

$$(\mathbf{C}, \otimes, e) \rightarrow (\mathbf{D}, \bullet, u).$$

A *monoidal natural transformation*

$$\theta : (F, m) \Rightarrow (G, n) : (\mathbf{C}, \otimes, e) \rightarrow (\mathbf{D}, \bullet, u)$$

between the lax monoidal functors (F, m) and (G, n) is a natural transformation

$$\theta : F \Rightarrow G : \mathbf{C} \longrightarrow \mathbf{D}$$

between the underlying functors, making the two diagrams

$$\begin{array}{ccc}
 FA \bullet FB & \xrightarrow{\theta_A \bullet \theta_B} & GA \bullet GB \\
 \downarrow m & & \downarrow n \\
 F(A \otimes B) & \xrightarrow{\theta_{A \otimes B}} & G(A \otimes B)
 \end{array}
 \qquad
 \begin{array}{ccc}
 & u & \\
 m \swarrow & & \searrow n \\
 Fe & \xrightarrow{\theta_e} & Ge
 \end{array}$$

commute, for all objects A and B of the category \mathbf{C} .

5.5 Monoidal natural transformations (between oplax functors)

The definition of monoidal natural transformation formulated in Section 5.4 for lax monoidal functors is easily adapted to the oplax situation. A *monoidal natural transformation*

$$\theta : (F, m) \Rightarrow (G, n) : (\mathbf{C}, \otimes, e) \longrightarrow (\mathbf{D}, \bullet, u)$$

between two oplax monoidal functors (F, m) and (G, n) is a natural transformation

$$\theta : F \Rightarrow G : \mathbf{C} \longrightarrow \mathbf{D}$$

between the underlying functors, making the two diagrams

$$\begin{array}{ccc}
 F(A \otimes B) & \xrightarrow{\theta_{A \otimes B}} & G(A \otimes B) \\
 \downarrow m & & \downarrow n \\
 FA \bullet FB & \xrightarrow{\theta_A \bullet \theta_B} & GA \bullet GB
 \end{array}
 \qquad
 \begin{array}{ccc}
 Fe & \xrightarrow{\theta_e} & Ge \\
 m \swarrow & & \searrow n \\
 & u &
 \end{array}$$

commute, for all objects A and B of the category \mathbf{C} . We have seen in Section 5.2 that every functor F between cartesian categories is oplax in a canonical way. We leave the reader to establish as an exercise that natural transformations between such functors are themselves monoidal.

Exercise. Suppose that $\theta : F \Rightarrow G : \mathbf{C} \longrightarrow \mathbf{D}$ is a natural transformation between two functors F and G acting on cartesian categories \mathbf{C} and \mathbf{D} . Show that the natural transformation θ is monoidal between the functors F and G understood as oplax monoidal functors. ■

5.6 Symmetric monoidal functors (lax and oplax)

We suppose here that the two monoidal categories (\mathbf{C}, \otimes, e) and (\mathbf{D}, \bullet, u) are symmetric, with symmetries noted γ^\otimes and γ^\bullet respectively. A lax monoidal functor

$$(F, m) : (\mathbf{C}, \otimes, e) \longrightarrow (\mathbf{D}, \bullet, u)$$

is called *symmetric* when the diagram

$$\begin{array}{ccc} FA \bullet FB & \xrightarrow{\gamma^\bullet} & FB \bullet FA \\ m \downarrow & & \downarrow m \\ F(A \otimes B) & \xrightarrow{F\gamma^\otimes} & F(B \otimes A) \end{array}$$

commutes in the category \mathbf{D} for all objects A and B of the category \mathbf{C} . Similarly, an oplax monoidal functor

$$(F, n) : (\mathbf{C}, \otimes, e) \longrightarrow (\mathbf{D}, \bullet, u)$$

is called *symmetric* when the diagram

$$\begin{array}{ccc} F(A \otimes B) & \xrightarrow{F\gamma^\otimes} & F(B \otimes A) \\ n \downarrow & & \downarrow n \\ FA \bullet FB & \xrightarrow{\gamma^\bullet} & FB \bullet FA \end{array}$$

commutes in the category \mathbf{D} for all objects A and B of the category \mathbf{C} .

Exercise. We have seen in Section 5.2 that every functor F between cartesian categories lifts to an oplax monoidal functor (F, n) in a unique way. Show that this oplax monoidal functor is symmetric. ■

5.7 Functorial boxes in string diagrams

String diagrams may be extended with a notion of *functorial box* in order to depict functors between categories. In this notation, a functor

$$F : \mathbf{C} \longrightarrow \mathbf{D}$$

is represented as a *box* labeled by the label F , drawn around the morphism

$$f : A \longrightarrow B$$

transported by the functor from the category \mathbf{C} to the category \mathbf{D} .

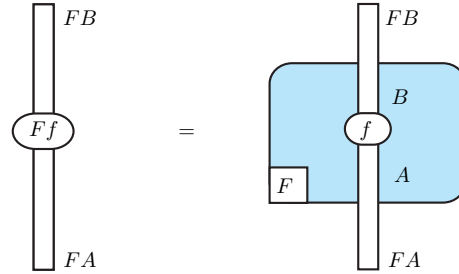

The purpose of a box is to separate an inside world from an outside world. In this case, the inside world is the source category \mathbb{C} and the outside world is the target category \mathbb{D} . Observe in particular that a string of type FA outside the box (thus, in the category \mathbb{D}) becomes a string of type A (thus, in the category \mathbb{C}) when it crosses the frontier and enters the box. Similarly, a string of type B inside the box (in the category \mathbb{C}) becomes a string of type FB (in the category \mathbb{D}) when it crosses the frontier and leaves the box.

Given a pair of morphisms $f : A \rightarrow B$ and $g : B \rightarrow C$, the two functorial equalities

$$F(g \circ f) = Fg \circ Ff \quad F(A) = FA$$

are depicted in a graphically pleasant way:

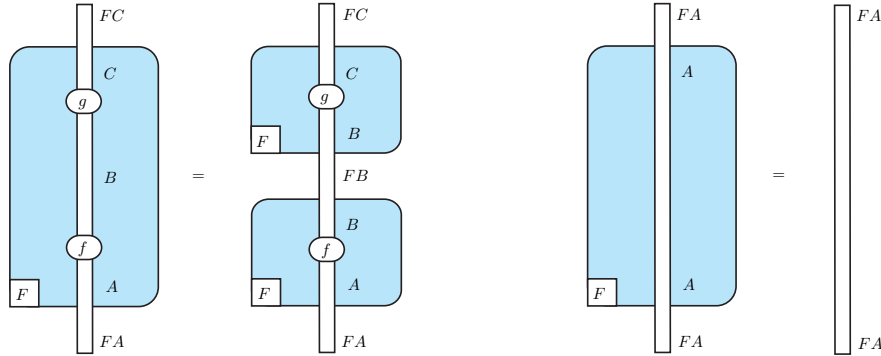

Observe that exactly one string enters and exits each functorial box F . We will see below that the purpose of monoidal functors is precisely to implement functorial boxes with multiple inputs and outputs.

Let us explain how this is achieved. Consider a lax monoidal functor F with coercion maps m . Given k objects in the category \mathbb{C} , there are several ways to combine the coercion maps m in order to construct the morphism

$$m_{A_1, \dots, A_k} : F(A_1) \bullet \dots \bullet F(A_k) \rightarrow F(A_1 \otimes \dots \otimes A_k).$$

The definition of a lax monoidal functor, and more specifically the coherence diagrams recalled in Section 5.1, ensure that these various combinations define the same morphism m_{A_1, \dots, A_k} in the end. This morphism is nicely depicted as a box F in which k strings labelled A_1, \dots, A_k enter simultaneously, join together as

a unique string labelled $A_1 \otimes \cdots \otimes A_k$, which then exits the box. For illustration, the two structural morphisms $m_{[A_1, A_2, A_3]}$ and $m_{[-]}$ are depicted as follows:

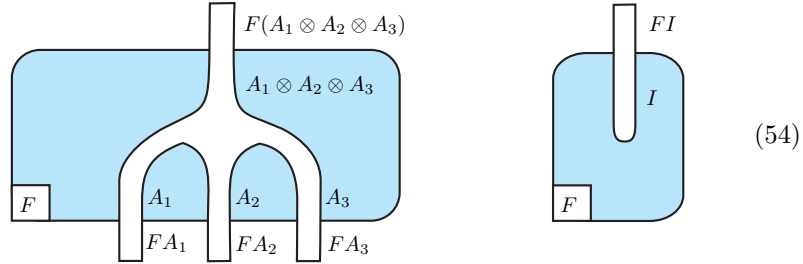

More generally, given a morphism

$$f : A_1 \otimes \cdots \otimes A_k \longrightarrow B$$

in the source category \mathbb{C} , one depicts the morphism

$$F(f) \circ m_{A_1 \dots A_k} : FA_1 \otimes \cdots \otimes FA_k \longrightarrow F(A_1 \otimes \cdots \otimes A_k) \longrightarrow FB$$

obtained by precomposing the image $F(f)$ with the coercion map $m_{A_1 \dots A_k}$ in the target category \mathbb{D} , as the functorial box below, with k inputs and exactly one output:

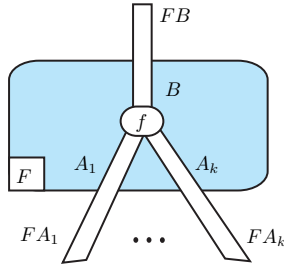

The coherence properties of a monoidal functor enable to “merge” two monoidal boxes in a string diagram, without changing its meaning:

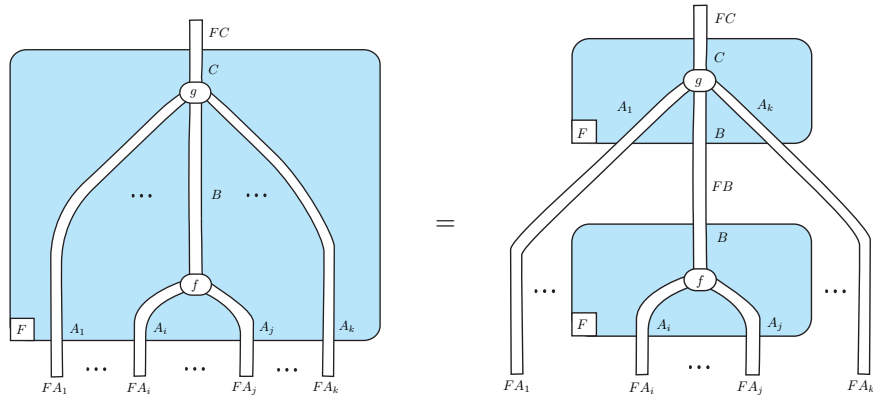

Note that an oplax monoidal functor may be depicted in a similar fashion, as a functorial box in which exactly one string enters, and several strings (possibly none) exit. A strong monoidal functor is at the same time a lax monoidal functor (F, m) and an oplax monoidal functor (F, n) . It is thus depicted as a functorial box in which several strings may enter, and several strings may exit. Besides, the coercion maps m are inverse to the coercion maps n . Two diagrammatic equalities follow, which enable to split a “strong monoidal” box horizontally:

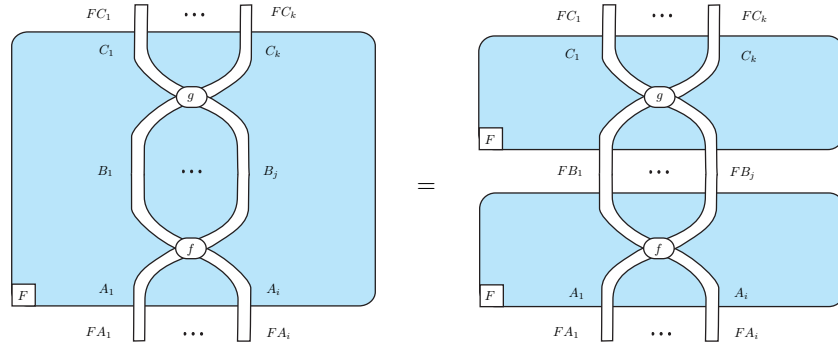

as well as vertically:

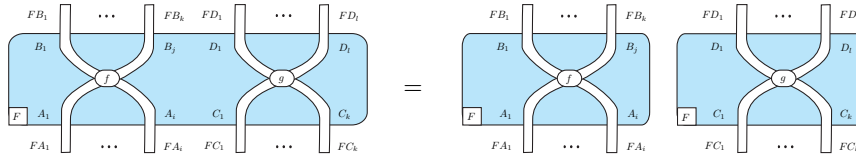

This diagrammatic account of monoidal functors extends to natural transformations. Suppose given a natural transformation

$$\theta : F \rightarrow G : \mathbf{C} \rightarrow \mathbf{D}$$

between two functors F and G . The naturality property of θ is depicted as the diagrammatic equality:

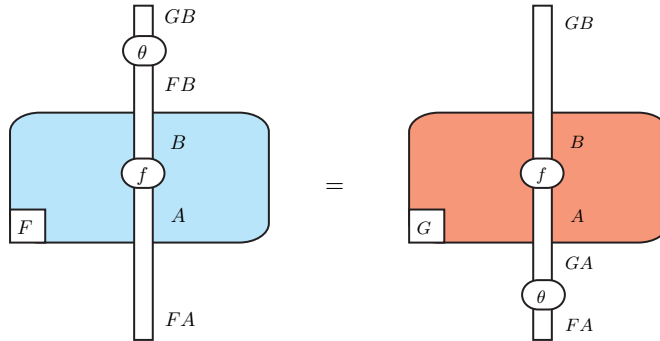

Now, suppose that the two categories \mathbf{C} and \mathbf{D} are monoidal, and that the natural transformation θ is *monoidal* between the two lax monoidal functors F and G . The monoidality condition on the natural transformation θ ensures the diagrammatic equality:

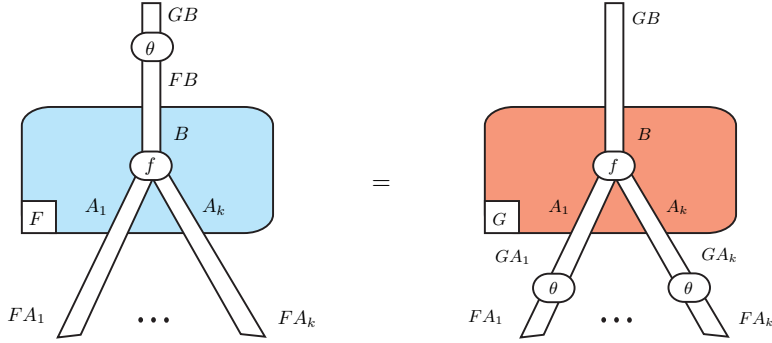

in which the natural transformation θ “transforms” the lax monoidal box F into the lax monoidal box G , and “replicates” as one natural transformation θ on each of the k strings A_1, \dots, A_k entering the lax monoidal boxes F and G . The notion of monoidal natural transformation between *oplax* monoidal functors leads to a similar pictorial equality, which the reader will easily guess by turning the page upside down.

5.8 The language of 2-categories

In order to define the notion of *monoidal adjunction* between monoidal categories, we proceed in three stages:

- In this section, we recall the notion of 2-category,
- In Section 5.9, we construct the 2-category **LaxMonCat** with monoidal categories as objects, lax monoidal functors as horizontal morphisms, and monoidal natural transformations as vertical morphisms,
- In Section 5.11, we define what one means by an *adjunction* in a 2-category, and apply the definition to the 2-category **LaxMonCat** in order to define the notion of monoidal adjunction.

Basically, a 2-category \mathcal{C} is a category in which the class $\mathcal{C}(A, B)$ of morphisms between two objects A and B is not a set, but a category. In other words, a 2-category is a category in which there exist morphisms $f : A \rightarrow B$ between objects, and also morphisms $\alpha : f \Rightarrow g$ between morphisms $f : A \rightarrow B$ and $g : A \rightarrow B$ with the same source and target. The underlying category is noted \mathcal{C}_0 . The morphisms $f : A \rightarrow B$ are called *horizontal morphisms*, and the morphisms $\alpha : f \Rightarrow g$ are called *vertical morphisms* or *cells*. They are generally represented as *2-dimensional arrows* between the *1-dimensional*

arrows $f : A \longrightarrow B$ and $g : A \longrightarrow B$ of the underlying category \mathcal{C}_0 :

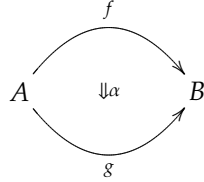

Cells may be composed “vertically” and “horizontally”. We write

$$\beta * \alpha \quad : \quad f \Rightarrow h$$

for the *vertical composite* of two cells $\alpha : f \Rightarrow g$ and $\beta : g \Rightarrow h$, which is represented diagrammatically as:

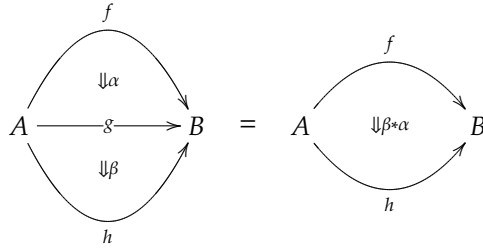

We write

$$\alpha_1 \circ \alpha_2 \quad : \quad f_2 \circ f_1 \Rightarrow g_2 \circ g_1$$

for the *horizontal composite* of two cells $\alpha_1 : f_1 \Rightarrow g_1$ and $\alpha_2 : f_2 \Rightarrow g_2$, represented diagrammatically as:

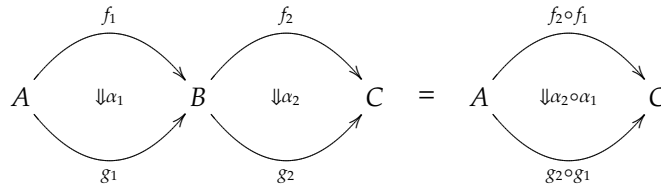

The vertical and horizontal composition laws are required to define categories: they are associative and have identities:

- the vertical composition has an identity cell $1^f : f \Rightarrow f$ for every morphism f of the underlying category \mathcal{C}_0 ,
- the horizontal composition has an identity cell $1_A : id_A \Rightarrow id_A$ for every object A and associated identity morphism $id_A : A \longrightarrow A$ of the underlying category \mathcal{C}_0 .

The interchange law asks that composing four cells

$$\alpha_1 : f_1 \Rightarrow g_1 \quad \beta_1 : g_1 \Rightarrow h_1 \quad \alpha_2 : f_2 \Rightarrow g_2 \quad \beta_2 : g_2 \Rightarrow h_2$$

vertically then horizontally as

$$(\beta_2 * \alpha_2) \circ (\beta_1 * \alpha_1) \quad : \quad f_2 \circ f_1 \Rightarrow h_2 \circ h_1$$

or horizontally then vertically as

$$(\beta_2 \circ \beta_1) * (\alpha_2 \circ \alpha_1) \quad : \quad f_2 \circ f_1 \Rightarrow h_2 \circ h_1$$

as in the diagram below

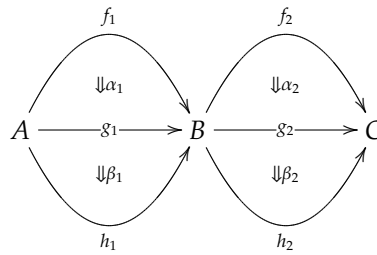

makes no difference:

$$(\beta_2 * \alpha_2) \circ (\beta_1 * \alpha_1) \quad = \quad (\beta_2 \circ \beta_1) * (\alpha_2 \circ \alpha_1)$$

Finally, two coherence axioms are required on the identities: first of all

$$1^{f_2} \circ 1^{f_1} \quad = \quad 1^{f_2 \circ f_1}$$

for every pair of horizontal morphisms $f_1 : A \longrightarrow B$ and $f_2 : B \longrightarrow C$, then

$$1_A \quad = \quad 1^{id_A}$$

requiring that the horizontal 2-dimensional identity 1_A coincides with the vertical 2-dimensional identity 1^{id_A} on the 1-dimensional identity morphism $id_A : A \longrightarrow A$, for every object A .

Exercise. Show that every pair of morphisms $h_1 : A \longrightarrow B$ and $h_2 : C \longrightarrow D$ in a 2-category \mathcal{C} defines a functor from the category $\mathcal{C}(B, C)$ to the category $\mathcal{C}(A, D)$ which transports every cell

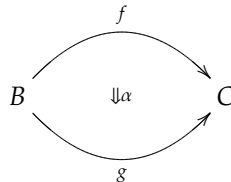

to the cell

$$\begin{array}{ccc}
 & h_2 \circ f \circ h_1 & \\
 & \curvearrowright & \\
 A & \Downarrow 1^{h_2} \circ \alpha \circ 1^{h_1} & D \\
 & \curvearrowleft & \\
 & h_2 \circ g \circ h_1 &
 \end{array}$$

■

5.9 The 2-category of monoidal categories and lax functors

We start by recalling a well-known property of category theory:

Proposition 8 *Categories, functors and natural transformations define a 2-category, noted \mathbf{Cat} .*

Proof. The vertical composite $\theta * \zeta$ of two natural transformations

$$\zeta : F \Rightarrow G : \mathbb{C} \longrightarrow \mathbb{D} \quad \text{and} \quad \theta : G \Rightarrow H : \mathbb{C} \longrightarrow \mathbb{D}$$

is defined as the natural transformation

$$\theta * \zeta : F \Rightarrow H : \mathbb{C} \longrightarrow \mathbb{D}$$

with components

$$(\theta * \zeta)_A : FA \xrightarrow{\zeta_A} GA \xrightarrow{\theta_A} HA.$$

The horizontal composite $\theta \circ \zeta$ of two natural transformations

$$\zeta : F_1 \Rightarrow G_1 : \mathbb{C} \longrightarrow \mathbb{D} \quad \text{and} \quad \theta : F_2 \Rightarrow G_2 : \mathbb{D} \longrightarrow \mathbb{E}$$

is defined as the natural transformation

$$\theta \circ \zeta : F_2 \circ F_1 \Rightarrow G_2 \circ G_1 : \mathbb{C} \longrightarrow \mathbb{E}$$

with components

$$(\theta \circ \zeta)_A : F_2 F_1 A \longrightarrow G_2 G_1 A$$

defined as the diagonal of the commutative square

$$\begin{array}{ccc}
 F_2 F_1 A & \xrightarrow{F_2 \zeta_A} & F_2 G_1 A \\
 \theta_{F_1 A} \downarrow & & \downarrow \theta_{G_1 A} \\
 G_2 F_1 A & \xrightarrow{G_2 \zeta_A} & G_2 G_1 A
 \end{array}$$

We leave the reader to check as an exercise that the constructions just defined satisfy the axioms of a 2-category. \square

The whole point of introducing the notion of 2-category in Section 5.8 is precisely that:

Proposition 9 *Monoidal categories, lax monoidal functors and monoidal natural transformations between lax monoidal functors define a 2-category, noted **LaxMonCat**.*

Proof. The composite of two lax monoidal functors

$$(F, m) : (\mathbf{C}, \otimes, e) \longrightarrow (\mathbf{D}, \bullet, u) \quad \text{and} \quad (G, n) : (\mathbf{D}, \bullet, u) \longrightarrow (\mathbf{E}, \cdot, i)$$

is defined as the composite $G \circ F$ of the two underlying functors F and G , equipped with the mediating maps:

$$GFA \cdot GFB \xrightarrow{n} G(FA \bullet FB) \xrightarrow{Gm} GF(A \otimes B)$$

and

$$i \xrightarrow{n} Gu \xrightarrow{Gm} GFe.$$

The vertical and horizontal composition of monoidal natural transformations are defined just as in the 2-category **Cat**. We leave the reader to check that the vertical and horizontal composites of monoidal natural transformations define *monoidal* natural transformations, and from this, that the constructions satisfy the axioms of a 2-category. \square

It is not difficult to establish in the same way that

Proposition 10 *Symmetric monoidal categories, symmetric lax monoidal functors and monoidal natural transformations between lax monoidal functors define a 2-category, noted **SymMonCat**.*

Proposition 11 *Symmetric monoidal categories, symmetric oplax monoidal functors and monoidal natural transformations between oplax monoidal functors define a 2-category, noted **SymOplaxMonCat**.*

Exercise. Show that every 2-category considered in this section:

Cat **LaxMonCat** **SymMonCat** **SymOplaxMonCat**

are cartesian as categories, and also as 2-categories. This means that every pair of objects A and B is equipped with two projection morphisms

$$A \times B \xrightarrow{\pi_1} A \qquad A \times B \xrightarrow{\pi_2} B$$

satisfying the following universal property: for every pair of vertical morphisms

$$\theta_f \quad : \quad f_1 \Rightarrow f_2 \quad : \quad X \longrightarrow A$$

$$\theta_g : g_1 \Rightarrow g_2 : X \longrightarrow B$$

there exists a unique vertical morphism

$$\langle \theta_f, \theta_g \rangle : \langle f_1, g_1 \rangle \Rightarrow \langle f_2, g_2 \rangle : X \longrightarrow A \times B$$

satisfying the two equalities below:

$$\begin{array}{ccc}
 \begin{array}{c}
 \langle f_1, g_1 \rangle \\
 \curvearrowright \\
 X \xrightarrow{\quad} A \times B \xrightarrow{\pi_1} A \\
 \curvearrowleft \\
 \langle f_2, g_2 \rangle \\
 \Downarrow \langle \theta_f, \theta_g \rangle
 \end{array}
 & = &
 \begin{array}{c}
 f_1 \\
 \curvearrowright \\
 X \xrightarrow{\quad} A \\
 \curvearrowleft \\
 f_2 \\
 \Downarrow \theta_f
 \end{array} \\
 \\
 \begin{array}{c}
 \langle f_1, g_1 \rangle \\
 \curvearrowright \\
 X \xrightarrow{\quad} A \times B \xrightarrow{\pi_2} B \\
 \curvearrowleft \\
 \langle f_2, g_2 \rangle \\
 \Downarrow \langle \theta_f, \theta_g \rangle
 \end{array}
 & = &
 \begin{array}{c}
 g_1 \\
 \curvearrowright \\
 X \xrightarrow{\quad} B \\
 \curvearrowleft \\
 g_2 \\
 \Downarrow \theta_g
 \end{array}
 \end{array}$$

Show that every such cartesian 2-category is also a cartesian category [Hint: restrict the universality property to vertical identity morphisms.] ■

5.10 Adjunctions between functors

By definition, an adjunction is a triple (F_*, F^*, ϕ) consisting of two functors

$$F_* : \mathbf{C} \longrightarrow \mathbf{D} \quad F^* : \mathbf{D} \longrightarrow \mathbf{C}$$

and a family of bijections

$$\phi_{A,B} : \mathbf{C}(A, F^*B) \cong \mathbf{D}(F_*A, B)$$

indexed by objects A of the category \mathbf{C} , and objects B of the category \mathbf{D} . The functor F_* is called *left adjoint* to the functor F^* , and one writes

$$F_* \dashv F^*.$$

Besides, the family ϕ is required to be natural in A and B . This point is sometimes misunderstood, or simply forgotten. For that reason, we explain it briefly here. Suppose we have a morphism

$$h : A \longrightarrow F^*B$$

in the category \mathbf{C} , and a pair of morphisms $h_A : A' \longrightarrow A$ in the category \mathbf{C} and $h_B : B \longrightarrow B'$ in the category \mathbf{D} . The two morphisms h_A and h_B should be

understood as *actions* in the group-theoretic sense, transporting the morphism h to the morphism

$$h' = F^*(h_B) \circ h \circ h_A \quad : \quad A' \longrightarrow F^*B'.$$

The morphism h' is alternatively defined as making the diagram

$$\begin{array}{ccc} A & \xrightarrow{h} & F^*B \\ h_A \uparrow & & \downarrow F^*h_B \\ A' & \xrightarrow{h'} & F^*B' \end{array}$$

commute in the category \mathbf{C} .

Note however that the action of h_A and h_B on the set $\mathbf{C}(A, F^*B)$ is not *exactly* a group action, because the action transports an element $h \in \mathbf{C}(A, F^*B)$ to an element $h' \in \mathbf{C}(A', F^*B')$ of a *potentially different* set of morphisms. It is worth remembering at this point that a category may be seen as a monoid with several objects. Accordingly, the function

$$\mathbf{C}(A, F^*B) \longrightarrow \mathbf{C}(A', F^*B')$$

defined by the action of h_A and h_B may be seen as component of a functor

$$\mathbf{C}(-, F^*-) \quad : \quad \mathbf{C}^{op} \times \mathbf{D} \quad \longrightarrow \quad \mathbf{Set}$$

where \mathbf{Set} denotes the category with sets as objects, and functions as morphisms. This functor generalizes the familiar notion of *group action* to a setting with several objects. Thus, it may be called a *categorical action* of the categories \mathbf{C}^{op} and \mathbf{D} on the family of sets $\mathbf{C}(A, F^*B)$.

Naturality means that the bijection ϕ preserves this action of the categories \mathbf{C}^{op} and \mathbf{D} on the families of sets $\mathbf{C}(A, F^*B)$ and $\mathbf{D}(F_*A, B)$. Hence, expressed in a concise and conceptual fashion, naturality in A and B means that ϕ defines a natural transformation

$$\phi \quad : \quad \mathbf{C}(-, F^*-) \Rightarrow \mathbf{D}(F_*-, -) \quad : \quad \mathbf{C}^{op} \times \mathbf{D} \longrightarrow \mathbf{Set}.$$

Equivalently, naturality in A and B means that the equality

$$\phi_{A', B'}(h') \quad = \quad h_B \circ \phi_{A, B}(h) \circ F_*(h_A)$$

is satisfied, that is, that the diagram

$$\begin{array}{ccc} F_*A & \xrightarrow{\phi_{A, B}(h)} & B \\ F_*h_A \uparrow & & \downarrow h_B \\ F_*A' & \xrightarrow{\phi_{A', B'}(h')} & B' \end{array}$$

commutes in the category \mathbf{D} , for all morphisms h , h_A and h_B .

5.11 Adjunctions in the language of 2-categories

The definition of adjunction exposed in the previous section may be reformulated in an elegant and conceptual way, using the language of 2-categories. This reformulation is based on the observation

- that an object A in the category \mathbf{C} is the same thing as a functor $[A]$ from the category $\mathbb{1}$ (the category with one object equipped with its identity morphism) to the category \mathbf{C} ,
- that a morphism $h : A \rightarrow B$ in the category \mathbf{C} is the same thing as a natural transformation $[h] : [A] \Rightarrow [B]$ between the functors representing the objects A and B ,
- that the functor $[A] : \mathbb{1} \rightarrow \mathbf{C}$ composed with the functor $F_* : \mathbf{C} \rightarrow \mathbf{D}$ coincides with the functor $[F_*A]$ associated to the object F_*A

$$F_* \circ [A] = [F_*A] : \mathbb{1} \rightarrow \mathbf{D}$$

for every object A of the category \mathbf{C} . And similarly, that

$$F^* \circ [B] = [F^*B] : \mathbb{1} \rightarrow \mathbf{C}$$

for every object B of the category \mathbf{D} .

Putting all this together, the adjunction $\phi_{A,B}$ becomes a bijection between the natural transformations

$$[A] \Rightarrow F^* \circ [B] : \mathbb{1} \rightarrow \mathbf{C}$$

and the natural transformations

$$F_* \circ [A] \Rightarrow [B] : \mathbb{1} \rightarrow \mathbf{D}.$$

Diagrammatically, the bijection $\phi_{A,B}$ defines a one-to-one relationship between the cells

$$\begin{array}{ccc}
 & [A] \rightarrow & \mathbf{C} \\
 \mathbb{1} & \curvearrowright & \downarrow F^* \\
 & [B] \rightarrow & \mathbf{D}
 \end{array}$$

and the cells

$$\begin{array}{ccc}
 & [A] \rightarrow & \mathbf{C} \\
 \mathbb{1} & \curvearrowright & \downarrow F_* \\
 & [B] \rightarrow & \mathbf{D}
 \end{array}$$

in the 2-category **Cat**. Interestingly, it is possible to replace the category \mathbb{I} by any category \mathbb{E} in the bijection below. We leave the proof as pedagogical exercise to the reader.

Exercise. Show that for every adjunction (F_*, F^*, ϕ) the family ϕ extends to a family (also noted ϕ) indexed by pairs of coinitial functors

$$A : \mathbb{E} \longrightarrow \mathbf{C} \qquad B : \mathbb{E} \longrightarrow \mathbf{D}$$

whose components $\phi_{A,B}$ define a bijection between the natural transformations

$$A \Rightarrow F^* \circ B \quad : \quad \mathbb{E} \longrightarrow \mathbf{C}$$

and the natural transformations

$$F_* \circ A \Rightarrow B \quad : \quad \mathbb{E} \longrightarrow \mathbf{C}.$$

Formulate accordingly the naturality condition on the extended family ϕ . ■

The discussion (and exercise) leads us to a pleasant definition of adjunction in a 2-category. From now on, we suppose given a 2-category \mathcal{C} . An *adjunction* in the 2-category \mathcal{C} is defined as a triple (f_*, f^*, ϕ) consisting of two morphisms

$$f_* : C \longrightarrow D \qquad f^* : D \longrightarrow C$$

and a family of bijections

$$\phi_{a,b} \quad : \quad \mathbf{C}(E, C)(a, f^* \circ b) \cong \mathbf{C}(E, D)(f_* \circ a, b)$$

indexed by pairs of coinitial morphisms

$$a : E \longrightarrow C \qquad b : E \longrightarrow D$$

in the 2-category \mathcal{C} . In that case, the morphism f_* is called *left adjoint* to the morphism f^* in the 2-category \mathcal{C} , and one writes

$$f_* \dashv f^*.$$

The family ϕ is required to be natural in a and b , in the following sense. Suppose that the bijection $\phi_{a,b}$ transports the cell θ to the cell $\zeta = \phi_{a,b}(\theta)$ — as depicted below.

$$\begin{array}{ccc}
 \begin{array}{ccc}
 & a \longrightarrow & C \\
 E & \Downarrow \theta & \uparrow f^* \\
 & b \longrightarrow & D
 \end{array}
 & \xrightarrow{\phi_{a,b}} &
 \begin{array}{ccc}
 & a \longrightarrow & C \\
 E & \Downarrow \zeta & \downarrow f_* \\
 & b \longrightarrow & D
 \end{array}
 \end{array}$$

Suppose given a morphism $h : F \longrightarrow E$ and two cells

$$\alpha : a' \Rightarrow a \circ h : F \longrightarrow C \qquad \beta : b \circ h \Rightarrow b' : F \longrightarrow D$$

represented diagrammatically as:

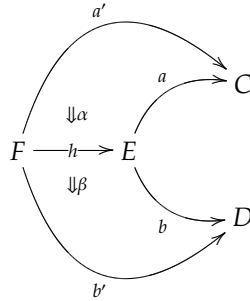

Naturality in a and b means that the bijection $\phi_{a,b}$ preserves the actions of the cells α and β , in the following sense: the bijection $\phi_{a',b'}$ transports the cell θ' obtained by pasting together the three cells α, β, θ to the cell ζ' obtained by pasting together the three cells α, β, ζ — as depicted below.

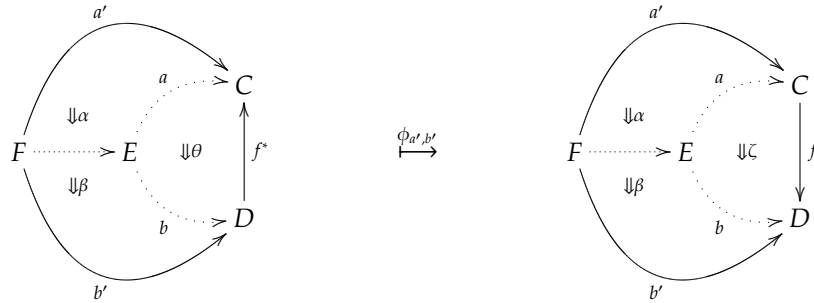

Exercise. Show that the definition of adjunction given in Section 5.10 coincides with this definition of adjunction expressed in the 2-category **Cat**. Show moreover that the original formulation of naturality is limited to the instance in which $E = F$ is the category $\mathbb{1}$ with one object, and $h : F \rightarrow E$ is the identity functor on that category. ■

5.12 Another formulation: the triangular identities

As just defined in Section 5.11, suppose given an adjunction (f_*, f^*, ϕ) in a 2-category \mathcal{C} . The two cells

$$\eta : id_C \Rightarrow f^* \circ f_* \qquad \varepsilon : f_* \circ f^* \Rightarrow id_D$$

are defined respectively as the cells related to the vertical identity cells 1^{f_*} and 1^{f^*} by the bijections ϕ_{id_C, f_*} and ϕ_{f^*, id_D} — as depicted below.

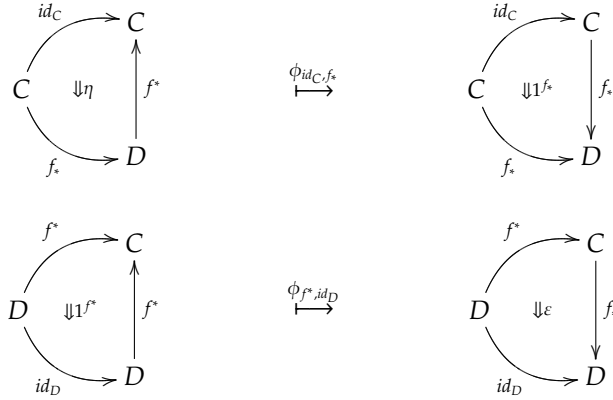

This leads to a purely algebraic (and equivalent) definition of adjunction in the 2-category \mathcal{C} . An adjunction is alternatively defined as a quadruple $(f_*, f^*, \eta, \epsilon)$ consisting of two morphisms:

$$f_* : C \longrightarrow D \quad f^* : D \longrightarrow C$$

and two cells

$$\eta : id_C \Rightarrow f^* \circ f_* \quad \epsilon : f_* \circ f^* \Rightarrow id_D$$

satisfying the two *triangular identities* below:

$$(\epsilon \circ f_*) * (f_* \circ \eta) = 1^{f_*} : C \longrightarrow D$$

and

$$(f^* \circ \epsilon) * (\eta \circ f^*) = 1^{f^*} : D \longrightarrow C.$$

The morphisms $f^* \circ f_*$ and $f_* \circ f^*$ are called the *monad* and the *comonad* of the adjunction, respectively. The cells η and ϵ are called respectively the *unit* of the monad $f^* \circ f_*$ and the *counit* of the comonad $f_* \circ f^*$.

Diagrammatically, the two triangular identities are represented as:

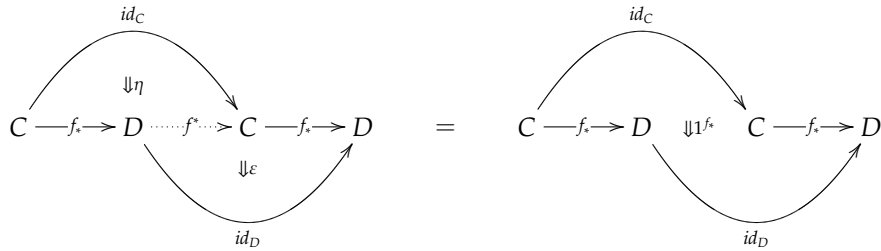

$$\begin{array}{ccc}
 & \text{id}_C & \\
 & \curvearrowright & \\
 D & \xrightarrow{f^*} C & \xrightarrow{\dots f_* \dots} D \xrightarrow{f^*} C \\
 & \Downarrow \eta & \\
 & \text{id}_D & \\
 & \curvearrowleft & \\
 & \Downarrow \varepsilon & \\
 & \text{id}_D & \\
 & \curvearrowright & \\
 & \text{id}_C & \\
 & \Downarrow \eta^* & \\
 D & \xrightarrow{f^*} C & \xrightarrow{f^*} D \xrightarrow{f^*} C \\
 & \Downarrow \varepsilon & \\
 & \text{id}_D & \\
 & \curvearrowleft & \\
 & \text{id}_D & \\
 & \curvearrowright & \\
 & \text{id}_C &
 \end{array} =$$

We leave to the reader (exercise below) the proof that this formulation of adjunction coincides with the previous one.

Exercise. Show that the definition of adjunction based on triangular identities is equivalent to the definition of adjunction in a 2-category \mathcal{C} formulated in Section 5.11. ■

5.13 A dual definition of adjunction

The definition of adjunction formulated in Section 5.12 is not only remarkable for its conciseness; it is also remarkable for its self-duality. Notice indeed that an adjunction $(f_*, f^*, \eta, \varepsilon)$ in a 2-category \mathcal{C} induces an adjunction

$$(f_*)^{op} \dashv (f^*)^{op}$$

between the morphisms

$$(f_*)^{op} : D \longrightarrow C \quad (f^*)^{op} : C \longrightarrow D$$

in the 2-category \mathcal{C}^{op} in which the direction of every morphism is reversed (but the direction of cells is maintained.)

From this, it follows mechanically that the original definition of adjunction formulated in Section 5.11 may be dualized! An adjunction in a 2-category \mathcal{C} is thus alternatively defined as a triple (f_*, f^*, ψ) consisting of two morphisms

$$f_* : C \longrightarrow D \quad f^* : D \longrightarrow C$$

and a family of bijections

$$\psi_{a,b} : \mathbb{C}(C, E)(a, b \circ f_*) \cong \mathbb{C}(D, E)(a \circ f^*, b)$$

indexed by pairs of cofinal morphisms

$$a : C \longrightarrow E, \quad b : D \longrightarrow E$$

in the 2-category \mathcal{C} . The family ψ of bijections should be natural in a and b in a dualized sense of Section 5.11. Suppose that the bijection $\psi_{a,b}$ transports the cell θ to the cell $\zeta = \psi_{a,b}(\theta)$ — as depicted below.

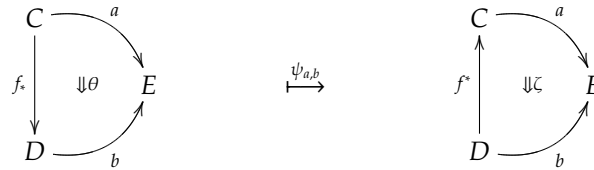

Suppose given a morphism $h : E \rightarrow F$ and two cells

$$\alpha : a' \Rightarrow h \circ a : C \rightarrow F \quad \beta : h \circ b \Rightarrow b' : D \rightarrow F$$

represented diagrammatically as:

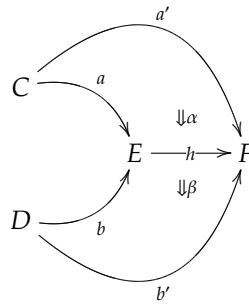

Just as in Section 5.11, naturality in a and b means that the bijection $\psi_{a,b}$ preserves the actions of the cells α and β . Namely, the bijection $\psi_{a',b'}$ transports the cell θ' obtained by pasting together the three cells α, β, θ to the cell ζ' obtained by pasting together the three cells α, β, ζ — as depicted below.

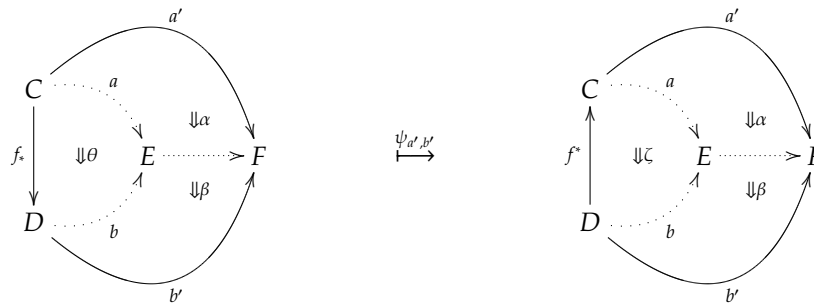

It is thus possible to define an adjunction as a triple (f_*, f^*, ϕ) in the style of Section 5.11, or as a triple (f_*, f^*, ψ) as just done here. Remarkably, the two bijections ϕ and ψ are *compatible* in the following sense. Suppose given two cells

$$\theta_1 : f_* \circ a_1 \Rightarrow b_1 : E_1 \rightarrow D \quad \theta_2 : a_2 \circ f^* \Rightarrow b_2 : D \rightarrow E_2$$

depicted as follows:

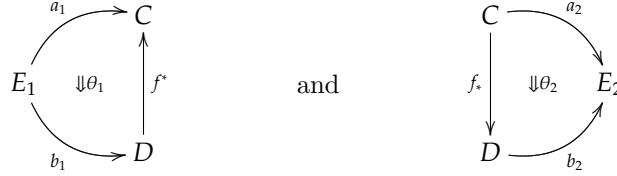

The equality

$$(\psi_{a_2, b_2}(\theta_2) \circ 1^{b_1}) * (1^{a_2} \circ \theta_1) = (1^{b_2} \circ \phi_{a_1, b_1}(\theta_1)) * (\theta_2 \circ 1^{a_1})$$

between cells $a_2 \circ a_1 \Rightarrow b_2 \circ b_1$ is then satisfied; diagrammatically speaking:

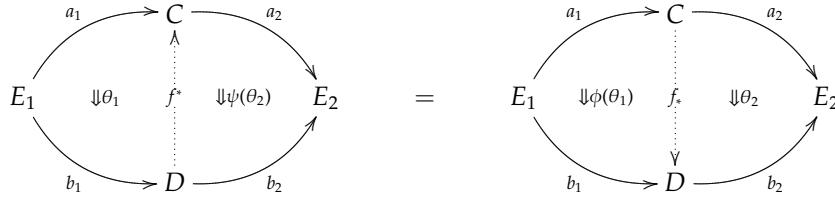

Exercise. Deduce the triangular identities of Section 5.12 from the compatibility just mentioned between the bijections ϕ and ψ . ■

5.14 Monoidal adjunctions

Basically, the notion of *monoidal adjunction* is defined by instantiating the general definition of adjunction in a 2-category, to the particular 2-category **LaxMonCat** introduced in Section 5.9. Among the three equivalent definitions of adjunction, we choose to apply the definition based on triangular identities (in Section 5.11). This definition provides indeed a particularly simple formulation of monoidal adjunctions, seen as refinements of usual adjunctions in **Cat**. We will see later, in Section 5.16, how to characterize these monoidal adjunctions in a very simple way – this providing a precious tool for the construction of models of linear logic. Suppose given a pair of lax monoidal functors:

$$(F_*, m) : (\mathbf{C}, \otimes, e) \longrightarrow (\mathbf{D}, \bullet, u) \quad (F^*, n) : (\mathbf{D}, \bullet, u) \longrightarrow (\mathbf{C}, \otimes, e).$$

A monoidal adjunction

$$(F_*, m) \dashv (F^*, n)$$

between the lax monoidal functors is simply defined as an adjunction $(F_*, F^*, \eta, \varepsilon)$ between the underlying functors

$$F_* : \mathbf{C} \longrightarrow \mathbf{D} \quad F^* : \mathbf{D} \longrightarrow \mathbf{C}$$

whose natural transformations

$$\eta : id_{\mathbf{C}} \Rightarrow F^* \circ F_* \quad \varepsilon : F_* \circ F^* \Rightarrow id_{\mathbf{D}}$$

are *monoidal* in the sense elaborated in Section 5.4.

5.15 A duality between lax and oplax monoidal functors

As a preliminary step towards the characterization of monoidal adjunctions formulated next section, we establish the existence of a one-to-one relationship between the lax monoidal structures p equipping a right adjoint functor F^* and the oplax monoidal structures n equipping a left adjoint functor F_* between two monoidal categories. So, suppose given two monoidal categories (\mathbb{C}, \otimes, e) and (\mathbb{D}, \bullet, u) as well as a functor $F_* : \mathbb{C} \rightarrow \mathbb{D}$ left adjoint to a functor $F^* : \mathbb{D} \rightarrow \mathbb{C}$. Diagrammatically:

$$\begin{array}{ccc} & F_* & \\ \mathbb{C} & \begin{array}{c} \curvearrowright \\ \perp \\ \curvearrowleft \end{array} & \mathbb{D} \\ & F^* & \end{array}$$

In this situation,

Proposition 12 *Every lax monoidal structure (F^*, p) on the functor F^* induces an oplax monoidal structure (F_*, n) on the functor F_* , defined as follows:*

$$n_{A,B}^2 : \begin{array}{ccc} F_*(A \otimes B) & & F_*A \bullet F_*B \\ \downarrow F_*(\eta \otimes \eta) & & \uparrow \varepsilon \\ F_*(F^*F_*A \otimes F^*F_*B) & \xrightarrow{F_*p} & F_*F^*(F_*A \bullet F_*B) \end{array}$$

$$n^0 : F_*e \xrightarrow{F_*p} F_*F^*u \xrightarrow{\varepsilon} u.$$

Conversely, every oplax monoidal structure (F_*, n) on the functor F_* induces a lax monoidal structure (F^*, p) on the functor F^* , defined as follows:

$$p_{A,B}^2 : \begin{array}{ccc} F^*A \otimes F^*B & & F_*A \bullet F_*B \\ \downarrow \eta & & \uparrow F^*(\varepsilon \bullet \varepsilon) \\ F^*F_*(F^*A \otimes F^*B) & \xrightarrow{F^*n} & F^*(F_*F^*A \bullet F_*F^*B) \end{array}$$

$$p^0 : e \xrightarrow{\eta} F^*F_*e \xrightarrow{F^*n} F^*u.$$

Moreover, the two functions $(p \mapsto n)$ and $(n \mapsto p)$ are inverse, and thus define a one-to-one relationship between the lax monoidal structures on the functor F^* and the oplax monoidal structures on the functor F_* .

Note that the oplax monoidal structure n may be defined alternatively from the lax monoidal structure p as the unique family of morphisms making the

5.16 A characterization of monoidal adjunctions

Here, we suppose given two monoidal categories (\mathbb{C}, \otimes, e) and (\mathbb{D}, \bullet, u) and a monoidal functor

$$(F_*, m) : (\mathbb{C}, \otimes, e) \longrightarrow (\mathbb{D}, \bullet, u).$$

Just as in Section 5.15, we suppose moreover that the functor F_* is left adjoint to a functor $F^* : \mathbb{D} \longrightarrow \mathbb{C}$. We investigate now when the adjunction

$$F_* \dashv F^*$$

may be lifted to a monoidal adjunction

$$(F_*, m) \dashv (F^*, p). \quad (55)$$

Obviously, this depends on the lax structure p chosen to equip the functor F^* . By Proposition 12 in Section 5.15, every such lax structure p is associated in a one-to-one fashion to an oplax structure n on the functor F_* . Hence, the question becomes: when does a pair of lax and oplax structures m and n on the functor F_* define a monoidal adjunction $(F_*, m) \dashv (F^*, p)$ by the bijection $n \mapsto p$?

The answer to this question is remarkably simple. We leave the reader to establish as an exercise that:

Exercise. Establish the two statements below:

- the oplax structure n is right inverse to the lax structure m if and only if the natural transformation η is monoidal from the identity functor on the category \mathbb{C} to the lax monoidal functor $(F^*, p) \circ (F_*, m)$,
- the oplax structure n is left inverse to the lax structure m if and only if the natural transformation ε is monoidal from the lax monoidal functor $(F_*, m) \circ (F^*, p)$ to the identity functor on the category \mathbb{D} .

By the oplax structure n is right inverse to the lax structure m , we mean that the morphisms

$$m_{A,B}^2 \circ n_{A,B}^2 : F_*(A \otimes B) \xrightarrow{n} F_*A \bullet F_*B \xrightarrow{m} F_*(A \otimes B)$$

$$m^0 \circ n^0 : F_*e \xrightarrow{n} u \xrightarrow{m} F_*e$$

coincide with the identity for every pair of objects A and B of the category \mathbb{C} . Similarly, by the oplax structure n is left inverse to the lax structure m , we mean that the morphisms

$$n_{A,B}^2 \circ m_{A,B}^2 : F_*A \bullet F_*B \xrightarrow{m} F_*(A \otimes B) \xrightarrow{n} F_*A \bullet F_*B$$

$$n^0 \circ m^0 : u \xrightarrow{m} F_*e \xrightarrow{n} u$$

coincide with the identity for every pair of objects A and B of the category \mathbb{C} .

■

This leads to the following characterization of monoidal adjunctions, originally noticed by Max Kelly.

Proposition 13 *Suppose given two monoidal categories (\mathbb{C}, \otimes, e) and (\mathbb{D}, \bullet, u) and a lax monoidal functor*

$$(F_*, m) : (\mathbb{C}, \otimes, e) \longrightarrow (\mathbb{D}, \bullet, u).$$

Suppose that the functor F_ is left adjoint to a functor*

$$F^* : \mathbb{D} \longrightarrow \mathbb{C}.$$

Then, the adjunction

$$F_* \dashv F^*$$

lifts to a monoidal adjunction

$$(F_*, m) \dashv (F^*, p)$$

if and only if the lax monoidal functor (F_, m) is strong. In that case, the lax structure p is associated by the bijection of Proposition 12 to the oplax structure $n = m^{-1}$ provided by the inverse of the lax structure m .*

In particular, the left adjoint functor (F_*, m) is strongly monoidal in every monoidal adjunction $(F_*, m) \dashv (F^*, p)$.

5.17 Symmetric monoidal adjunctions

The notion of *symmetric monoidal adjunction* is defined in the same fashion as for monoidal adjunctions, that is, by instantiating the general definition of adjunction in a 2-category, to the particular 2-category **SymMonCat** defined in Proposition 10 of Section 5.14. We explain briefly how the characterization of monoidal adjunctions formulated in the previous section is adapted to the symmetric case.

The 2-category **SymMonCat** has *symmetric* monoidal categories as objects, *symmetric* monoidal functors as horizontal morphisms, and monoidal natural transformations as vertical morphisms. So, a symmetric monoidal adjunction is simply a monoidal adjunction

$$(F_*, m) \dashv (F^*, p)$$

between two lax monoidal functors

$$(F_*, m) : (\mathbb{C}, \otimes, e) \longrightarrow (\mathbb{D}, \bullet, u) \qquad (F^*, p) : (\mathbb{D}, \bullet, u) \longrightarrow (\mathbb{C}, \otimes, e)$$

in which:

- the two monoidal categories (\mathbb{C}, \otimes, e) and (\mathbb{D}, \bullet, u) are equipped with symmetries γ^\otimes and γ^\bullet ,
- the two lax monoidal functors (F_*, m) and (F^*, p) are symmetric in the sense of Section 5.6.

Symmetric monoidal adjunctions may be characterized in the same way as monoidal adjunctions in Proposition 13. The important point to observe is that in Proposition 12 of Section 5.15, the lax monoidal functor (F^*, p) is symmetric if and only if the oplax monoidal functor (F_*, n) is symmetric. This leads to the following variant of the previous proposition:

Proposition 14 *Suppose given two symmetric monoidal categories (\mathbb{C}, \otimes, e) and (\mathbb{D}, \bullet, u) and a symmetric lax monoidal functor*

$$(F_*, m) : (\mathbb{C}, \otimes, e) \longrightarrow (\mathbb{D}, \bullet, u).$$

Suppose that the functor F_ is left adjoint to a functor*

$$F^* : \mathbb{D} \longrightarrow \mathbb{C}.$$

Then, the adjunction

$$F_* \dashv F^*$$

lifts to a symmetric monoidal adjunction

$$(F_*, m) \dashv (F^*, p)$$

if and only if the lax monoidal functor (F_, m) is strong. In that case, the lax structure p is associated by the bijection of Proposition 12 to the oplax structure $n = m^{-1}$ provided by the inverse of the lax structure m .*

5.18 Notes and references

The notion of adjunction was formulated for the first time in 1958 in an article by Daniel Kan [58]. The 2-categorical definition of adjunction was introduced in a seminal article by Ross Street [84]. We do not introduce the notion of Kan extension in this chapter, although the trained reader will recognize them immediately in our treatment of adjunctions exposed in Section 5.11. In fact, our description of adjunctions may be understood as a bottom-up reconstruction of the notion of *mate cell* introduced by Ross Street in [84]. The interested reader will find the relationship between adjunctions and Kan extensions already mentioned in the original paper by Daniel Kan, as well as in Chapter 10 of MacLane's book [66].

6 Monoids and monads

In this chapter, we recall the definitions and main properties of monoids and monads. Once dualized as comonoids and comonads, the two notions play a central role in the definition of the various categorical models of linear logic exposed in our next Chapter 7.

6.1 Monoids

A *monoid* in a monoidal category $(\mathbf{C}, \otimes, 1)$ is defined as a triple (A, m, u) consisting of an object A and two morphisms

$$1 \xrightarrow{u} A \xleftarrow{m} A \otimes A$$

making the *associativity* diagram

$$\begin{array}{ccc} (A \otimes A) \otimes A & \xrightarrow{m \otimes A} & A \otimes A \\ \alpha \downarrow & & \downarrow m \\ A \otimes (A \otimes A) & \xrightarrow{A \otimes m} & A \otimes A \xrightarrow{m} A \end{array}$$

and the two *unit* diagrams

$$\begin{array}{ccccc} 1 \otimes A & \xrightarrow{u \otimes A} & A \otimes A & \xleftarrow{A \otimes u} & A \otimes 1 \\ & \searrow \lambda & \downarrow m & \swarrow \rho & \\ & & A & & \end{array}$$

commute. A *monoid morphism*

$$f : (A, m_A, u_A) \longrightarrow (B, m_B, u_B)$$

between monoids (A, m_A, u_A) and (B, m_B, u_B) is defined as a morphism

$$f : A \longrightarrow B$$

between the underlying objects in the category \mathbf{C} , making the two diagrams

$$\begin{array}{ccc} A \otimes A & \xrightarrow{f \otimes f} & B \otimes B \\ m_A \downarrow & & \downarrow m_B \\ A & \xrightarrow{f} & B \end{array} \qquad \begin{array}{ccc} & 1 & \\ u_A \swarrow & & \searrow u_B \\ A & \xrightarrow{f} & B \end{array}$$

commute. A monoid defined in a symmetric monoidal category $(\mathbf{C}, \otimes, 1)$ is called *commutative* when the diagram

$$\begin{array}{ccc}
 A \otimes A & \xrightarrow{\gamma} & A \otimes A \\
 & \searrow m & \swarrow m \\
 & A &
 \end{array}$$

commutes.

Exercise. Show that one retrieves the usual notions of monoid, of commutative monoid and of monoid morphism when one applies these definitions to the monoidal category $(\mathbf{Set}, \times, 1)$ with sets as objects, functions as morphisms, cartesian product as tensor product, and terminal object as unit. ■

6.2 The category of monoids

One reason invoked by Jean Bénabou for introducing the notion of lax monoidal functor is its remarkable affinity with the traditional notion of monoid, see [11]. This affinity is witnessed by the following *lifting* property. To every monoidal category $(\mathbf{C}, \otimes, 1)$, one associates the category $\mathbf{Mon}(\mathbf{C}, \otimes, 1)$

- with objects the monoids,
- with morphisms the monoid morphisms.

Then, every lax monoidal functor

$$(F, n) : (\mathbf{C}, \otimes, e) \longrightarrow (\mathbf{D}, \bullet, u)$$

induces a functor

$$\mathbf{Mon}(F, n) : \mathbf{Mon}(\mathbf{C}, \otimes, e) \longrightarrow \mathbf{Mon}(\mathbf{D}, \bullet, u)$$

which transports a monoid (A, m_A, u_A) to the monoid (FA, m_{FA}, u_{FA}) defined as follows:

$$\begin{array}{l}
 m_{FA} : FA \otimes FA \xrightarrow{n^2} F(A \otimes A) \xrightarrow{Fm_A} FA \\
 u_{FA} : u \xrightarrow{n^0} Fe \xrightarrow{u_A} FA
 \end{array}$$

We leave it to the reader to check that $\mathbf{Mon}(F, n)$ does indeed define a functor. This may be established directly by simple diagram chasing, or more conceptually by completing the exercise below.

Exercise. Show that the category $\mathbb{1}$ consisting of one object and its identity morphism is monoidal. Show that a lax monoidal functor from the monoidal category $\mathbb{1}$ to a monoidal category $\mathbf{C} = (\mathbf{C}, \otimes, 1)$ is the same thing as a monoid

in this category; and that the category $\mathbf{LaxMonCat}(\mathbb{1}, \mathbf{C})$ coincides with the category $\mathbf{Mon}(\mathbf{C}, \otimes, 1)$ with monoids as objects and monoid morphisms as morphisms. Deduce the existence of the functor $\mathbf{Mon}(F, n)$ from 2-categorical considerations. ■

Note that the category $\mathbf{Mon}(\mathbf{C}, \otimes, 1)$ is not monoidal in general. However, the category becomes monoidal, even symmetric monoidal, when the underlying category $(\mathbf{C}, \otimes, 1)$ is *symmetric* monoidal.

Proposition 15 *Every symmetric monoidal category $(\mathbf{C}, \otimes, 1)$ induces a symmetric monoidal category $\mathbf{Mon}(\mathbf{C}, \otimes, 1)$ with the monoidal unit defined as*

$$1 \xrightarrow{id_1} 1 \xleftarrow{\lambda=\rho} 1 \otimes 1 \quad (56)$$

and the tensor product $(A \otimes B, m_{A \otimes B}, u_{A \otimes B})$ defined as

$$u_{A \otimes B} : \quad 1 \xrightarrow{\rho^{-1}=\lambda^{-1}} 1 \otimes 1 \xrightarrow{u_A \otimes u_B} A \otimes B$$

$$m_{A \otimes B} : \quad \begin{array}{ccc} (A \otimes B) \otimes (A \otimes B) & (A \otimes A) \otimes (B \otimes B) & \xrightarrow{m_A \otimes m_B} A \otimes B. \\ \alpha \downarrow & \uparrow \alpha & \\ A \otimes (B \otimes (A \otimes B)) & A \otimes (A \otimes (B \otimes B)) & \\ A \otimes \alpha^{-1} \downarrow & \uparrow A \otimes \alpha & \\ A \otimes ((B \otimes A) \otimes B) & \xrightarrow{A \otimes (\gamma \otimes B)} & A \otimes ((A \otimes B) \otimes B) \end{array}$$

as tensor product of two monoids (A, m_A, u_A) and (B, m_B, u_B) . Moreover, the forgetful functor

$$U : \mathbf{Mon}(\mathbf{C}, \otimes, 1) \longrightarrow (\mathbf{C}, \otimes, 1)$$

which transports a monoid (A, m, u) to its underlying object A is strict monoidal (that is, its coercion maps are provided by identities) and symmetric.

We observed at the beginning of the section that every lax monoidal functor between monoidal categories

$$(F, n) : (\mathbf{C}, \otimes, e) \longrightarrow (\mathbb{D}, \bullet, u)$$

lifts to a functor

$$\mathbf{Mon}(F, n) : \mathbf{Mon}(\mathbf{C}, \otimes, e) \longrightarrow \mathbf{Mon}(\mathbb{D}, \bullet, u).$$

We have seen moreover in Proposition 15 that when the monoidal categories (\mathbf{C}, \otimes, e) and (\mathbb{D}, \bullet, u) are symmetric, they induce symmetric monoidal categories $\mathbf{Mon}(\mathbf{C}, \otimes, e)$. In that situation, and when the lax monoidal functor (F, n) is symmetric, the functor $\mathbf{Mon}(F, n)$ lifts to a symmetric lax monoidal functor — equipped with the coercions n . This induces a commutative diagram of

symmetric lax monoidal functors:

$$\begin{array}{ccc} \text{Mon}(\mathbf{C}, \otimes, e) & \xrightarrow{\text{Mon}(F,n)} & \text{Mon}(\mathbf{D}, \bullet, u) \\ u \downarrow & & \downarrow u \\ (\mathbf{C}, \otimes, e) & \xrightarrow{(F,n)} & (\mathbf{D}, \bullet, u) \end{array}$$

A monoid in the category of monoid is the same thing as a commutative monoid: this phenomenon was first observed by Eckmann and Hilton. We suggest that the reader check this fact for himself in the following exercise. *Exercise.* Show that every commutative monoid in a symmetric monoidal category $(\mathbf{C}, \otimes, 1)$ lifts to a commutative monoid in the category $\text{Mon}(\mathbf{C}, \otimes, 1)$. Conversely, show that every monoid in the category $\text{Mon}(\mathbf{C}, \otimes, 1)$ is obtained in such a way. Conclude that the category $\text{Mon}(\text{Mon}(\mathbf{C}, \otimes, 1), \otimes, 1)$ is isomorphic (as a symmetric monoidal category) to the full subcategory of $\text{Mon}(\mathbf{C}, \otimes, 1)$ with commutative monoids as objects, equipped with the same monoidal structure as the surrounding category $\text{Mon}(\mathbf{C}, \otimes, 1)$. ■

André Joyal and Ross Street observe in [56] that the Eckmann-Hilton phenomenon applies also to monoidal categories: this says that a monoidal category in the 2-category of monoidal categories and strong monoidal functors, is the same thing as a braided monoidal category. The interested reader will check this fact in the following exercise.

Exercise. A *multiplication* on a monoidal category (\mathbf{C}, \otimes, e) is defined as a pair of strong monoidal functors

$$\begin{aligned} (\boxtimes, m) & : (\mathbf{C}, \otimes, e) \times (\mathbf{C}, \otimes, e) & \longrightarrow & (\mathbf{C}, \otimes, e) \\ (u, n) & : \mathbb{1} & \longrightarrow & (\mathbf{C}, \otimes, e) \end{aligned}$$

equipped with two monoidal natural transformations

$$\begin{array}{ccc} \mathbf{C} & \xrightarrow{id} & \mathbf{C} \\ \cong \downarrow & \Downarrow \bar{\lambda} & \uparrow \boxtimes \\ \mathbb{1} \times \mathbf{C} & \xrightarrow{u \times \mathbf{C}} & \mathbf{C} \times \mathbf{C} \end{array} \qquad \begin{array}{ccc} \mathbf{C} & \xrightarrow{id} & \mathbf{C} \\ \cong \downarrow & \Downarrow \bar{\rho} & \uparrow \boxtimes \\ \mathbf{C} \times \mathbb{1} & \xrightarrow{\mathbf{C} \times u} & \mathbf{C} \times \mathbf{C} \end{array}$$

Observe in particular that every multiplication includes an isomorphism

$$m_{A,B,C,D} : (A \otimes B) \boxtimes (C \otimes D) \longrightarrow (A \boxtimes C) \otimes (B \boxtimes D).$$

natural in A, B, C and D . Now, show that every braiding γ on a monoidal category $(\mathbf{C}, \otimes, 1)$ induces a multiplication where the two binary products coincide

$$A \boxtimes B := A \otimes B$$

and $m_{A,B,C,D}$ makes the diagram commute

$$\begin{array}{ccc}
 (A \otimes B) \otimes (C \otimes D) & \xrightarrow{m_{A,B,C,D}} & (A \otimes C) \otimes (B \otimes D) \\
 \downarrow \alpha & & \downarrow \alpha \\
 A \otimes (B \otimes (C \otimes D)) & & A \otimes (C \otimes (B \otimes D)) \\
 \downarrow A \otimes \alpha^{-1} & & \downarrow A \otimes \alpha^{-1} \\
 A \otimes ((B \otimes C) \otimes D) & \xrightarrow{A \otimes (\gamma_{B,C} \otimes D)} & A \otimes ((C \otimes B) \otimes D)
 \end{array}$$

and the extra structure defined just as expected:

$$\bar{\lambda}_A := \lambda_A^{-1} : A \longrightarrow 1 \otimes A \quad \bar{\rho}_A := \rho_A^{-1} : A \longrightarrow A \otimes 1 \quad u(*) := e.$$

Conversely, show that every multiplication on a monoidal category $(\mathbf{C}, \otimes, 1)$ induces a braiding γ possibly formulated as a natural transformation

$$\begin{array}{ccc}
 \mathbf{C} \times \mathbf{C} & \xrightarrow{\bar{\gamma}_{\mathbf{C}\mathbf{C}}} & \mathbf{C} \times \mathbf{C} \\
 \downarrow \otimes & \Downarrow \gamma & \downarrow \otimes \\
 & \mathbf{C} &
 \end{array}$$

and defined by pasting the natural transformations

$$\begin{array}{ccccc}
 & & \mathbf{C} \times \mathbf{C} & \xrightarrow{\bar{\gamma}_{\mathbf{C}\mathbf{C}}} & \mathbf{C} \times \mathbf{C} & & \\
 & & \downarrow \cong & & \downarrow \cong & & \\
 & & \mathbf{1} \times \mathbf{C} \times \mathbf{C} \times \mathbf{1} & \xrightarrow{\bar{\gamma}_{\mathbf{1} \times \mathbf{C} \times \mathbf{C} \times \mathbf{1}}} & \mathbf{C} \times \mathbf{1} \times \mathbf{1} \times \mathbf{C} & & \\
 \bar{\lambda} \times \bar{\rho} \Downarrow & & \downarrow u \times \mathbf{C} \times \mathbf{C} \times u & & \downarrow \mathbf{C} \times u \times u \times \mathbf{C} & & \bar{\rho} \times \bar{\lambda} \Leftarrow \\
 id & & \mathbf{C} \times \mathbf{C} \times \mathbf{C} \times \mathbf{C} & \xrightarrow{\bar{\gamma}_{\mathbf{C}\mathbf{C}}} & \mathbf{C} \times \mathbf{C} \times \mathbf{C} \times \mathbf{C} & & id \\
 & & \downarrow \boxtimes \boxtimes & & \downarrow \boxtimes \boxtimes & & \\
 & & \mathbf{C} \times \mathbf{C} & \xrightarrow{m} & \mathbf{C} \times \mathbf{C} & & \\
 & & \downarrow \otimes & & \downarrow \otimes & & \\
 & & \mathbf{C} & & \mathbf{C} & &
 \end{array}$$

More on the topic will be found in the original article by Joyal and Street [56].
 ■

6.3 Comonoids

Every category \mathbf{C} defines an opposite category \mathbf{C}^{op} obtained by reversing the direction of every morphism in the category \mathbf{C} . The resulting category \mathbf{C}^{op} has

the same objects as the category \mathbf{C} , and satisfies

$$\mathbf{C}^{op}(A, B) = \mathbf{C}(B, A)$$

for all objects A and B . A remarkable aspect of the theory of monoidal categories is its self-duality. Indeed, every monoidal category (\mathbf{C}, \otimes, e) defines a monoidal category $(\mathbf{C}^{op}, \otimes, e)$ on the opposite category \mathbf{C}^{op} , with same tensor product and unit as in the original category \mathbf{C} .

From this, it follows that every notion formulated in the theory of “monoidal categories” may be dualized by reversing the direction of morphisms in the definition. This principle is nicely illustrated by the notion of comonoid, which is dual to the notion of monoid formulated in Section 6.1. Hence, a *comonoid* in a monoidal category $(\mathbf{C}, \otimes, 1)$ is defined as a triple (A, d, e) consisting of an object A and two morphisms

$$1 \xleftarrow{e} A \xrightarrow{d} A \otimes A$$

making the *associativity* diagram

$$\begin{array}{ccccc} A & \xrightarrow{d} & A \otimes A & \xrightarrow{d \otimes A} & (A \otimes A) \otimes A \\ \downarrow d & & & & \downarrow \alpha \\ A \otimes A & \xrightarrow{A \otimes d} & A \otimes (A \otimes A) & & \end{array}$$

and the two *unit* diagrams

$$\begin{array}{ccccc} 1 \otimes A & \xleftarrow{e \otimes A} & A \otimes A & \xrightarrow{A \otimes e} & A \otimes 1 \\ \downarrow \lambda & & \uparrow d & & \downarrow \rho \\ A & \xleftarrow{id} & A & \xrightarrow{id} & A \end{array}$$

commute. A *comonoid morphism*

$$f : (A, d_A, e_A) \longrightarrow (B, d_B, e_B)$$

is defined as a morphism

$$f : A \longrightarrow B$$

between the underlying objects in the category \mathbf{C} , making the two diagrams

$$\begin{array}{ccc} A & \xrightarrow{f} & B \\ \downarrow d_A & & \downarrow d_B \\ A \otimes A & \xrightarrow{f \otimes f} & B \otimes B \end{array} \qquad \begin{array}{ccc} A & \xrightarrow{f} & B \\ \searrow e_A & & \swarrow e_B \\ & 1 & \end{array}$$

commute. A comonoid defined in a symmetric monoidal category $(\mathbf{C}, \otimes, 1)$ is called *commutative* when the diagram

$$\begin{array}{ccc} & A & \\ d \swarrow & & \searrow d \\ A \otimes A & \xrightarrow{\gamma} & A \otimes A \end{array}$$

commutes.

6.4 Cartesian categories among monoidal categories

In a cartesian category, every object defines a comonoid. Conversely, it is useful to know when a monoidal category $(\mathbf{C}, \otimes, 1)$, in which every object defines a comonoid, is a cartesian category. This is precisely what the next proposition clarifies.

Proposition 16 *Let $(\mathbf{C}, \otimes, 1)$ be a monoidal category. The monoidal structure is cartesian (that is, the tensor product is a cartesian product, and the tensor unit is terminal) if and only if there exists a pair of natural transformations d and e with components*

$$d_A : A \longrightarrow A \otimes A \qquad e_A : A \longrightarrow 1$$

such that:

1. (A, d_A, e_A) is a comonoid for every object A ,
2. the diagram

$$\begin{array}{ccc} A \otimes B & \xrightarrow{d_{A \otimes B}} & (A \otimes B) \otimes (A \otimes B) \\ \text{id} \downarrow & & \downarrow (A \otimes e_B) \otimes (e_A \otimes B) \\ A \otimes B & \xleftarrow{\rho \otimes \lambda} & (A \otimes 1) \otimes (1 \otimes B) \end{array} \quad (57)$$

commutes for all objects A and B ,

3. the component $e_1 : 1 \longrightarrow 1$ coincides with the identity morphism.

Proof. The direction (\Rightarrow) is reasonably immediate, and we leave it as exercise to the reader. We prove the other more difficult direction (\Leftarrow) . We show that for all objects A and B , the morphisms

$$\begin{array}{lcl} \pi_1 & : & A \otimes B \xrightarrow{A \otimes e_B} A \otimes 1 \xrightarrow{\rho} A \\ \pi_2 & : & A \otimes B \xrightarrow{e_A \otimes B} 1 \otimes B \xrightarrow{\lambda} B \end{array}$$

define the two projections of a cartesian product. To that purpose, we need to show that for all morphisms

$$f : X \longrightarrow A \qquad g : X \longrightarrow B$$

there exists a unique morphism

$$\langle f, g \rangle : X \longrightarrow A \otimes B$$

making the diagram

$$\begin{array}{ccc}
 & & A \\
 & \nearrow f & \\
 X & \xrightarrow{\langle f, g \rangle} & A \otimes B \\
 & \searrow g & \\
 & & B
 \end{array}
 \begin{array}{l}
 \nearrow \pi_1 \\
 \searrow \pi_2
 \end{array}
 \tag{58}$$

commute in the category \mathbf{C} . Existence follows easily from the definition of the morphism $\langle f, g \rangle$ as

$$\langle f, g \rangle : X \xrightarrow{d_X} X \otimes X \xrightarrow{f \otimes g} A \otimes B.$$

Indeed, one establishes by an elementary diagram chasing that Diagram (58) commutes. Typically, the equality $\pi_1 \circ \langle f, g \rangle = f$ holds because the diagram

$$\begin{array}{ccccc}
 X & \xrightarrow{d_X} & X \otimes X & \xrightarrow{f \otimes g} & A \otimes B \\
 \downarrow id & & \downarrow X \otimes e_X & \text{(b)} & \downarrow A \otimes e_B \\
 & \text{(a)} & X \otimes 1 & \xrightarrow{f \otimes 1} & A \otimes 1 \\
 & & \downarrow \rho & \text{(c)} & \downarrow \rho \\
 X & \xrightarrow{id} & X & \xrightarrow{f} & A
 \end{array}$$

(a) property of the comonoid X ,
 (b) g is a comonoid morphism,
 (c) ρ is natural.

commutes. We prove uniqueness. Suppose that a morphism $h : X \rightarrow A \otimes B$ makes the diagram

$$\begin{array}{ccc}
 & & A \\
 & \nearrow f & \\
 X & \xrightarrow{h} & A \otimes B \\
 & \searrow g & \\
 & & B
 \end{array}
 \begin{array}{l}
 \nearrow \pi_1 \\
 \searrow \pi_2
 \end{array}
 \quad (59)$$

commute. In that case, a simple diagram chasing shows that the two diagrams below commute in the category \mathbf{C} .

$$\begin{array}{ccc}
 X & \xrightarrow{d_X} & X \otimes X \\
 \downarrow h & (a) & \downarrow h \otimes h \\
 A \otimes B & \xrightarrow{d_{A \otimes B}} & (A \otimes B) \otimes (A \otimes B) \\
 \downarrow id & (b) & \downarrow (A \otimes e_B) \otimes (e_A \otimes B) \\
 A \otimes B & \xleftarrow{\rho \otimes \lambda} & (A \otimes 1) \otimes (1 \otimes B)
 \end{array}$$

(a) naturality of d ,
(b) Diagram (57).

$$\begin{array}{ccc}
 X & \xrightarrow{d_X} & X \otimes X \\
 \downarrow \langle f, g \rangle & (c) & \downarrow h \otimes h \\
 A \otimes B & \xleftarrow{f \otimes g} & (A \otimes B) \otimes (A \otimes B) \\
 \downarrow \rho \otimes \lambda & (d) & \downarrow (A \otimes e_B) \otimes (e_A \otimes B) \\
 A \otimes B & \xleftarrow{\rho \otimes \lambda} & (A \otimes 1) \otimes (1 \otimes B)
 \end{array}$$

(c) definition of $\langle f, g \rangle$
(d) Diagram (59) and definition of π_1 and π_2 .

From this follows that the two morphisms h and $\langle f, g \rangle$ coincide. We conclude that the tensor product is a cartesian product.

There only remains to show that the tensor unit is a terminal object. For every object A , there exists the morphism $e_A : A \rightarrow 1$. We claim that e_A is the unique morphism from the object A to the object 1 . Suppose that $f : A \rightarrow 1$

is any such morphism. By naturality of e , the diagram

$$\begin{array}{ccc} A & \xrightarrow{f} & 1 \\ & \searrow e_A & \swarrow e_1 \\ & 1 & \end{array}$$

commutes. From this and the hypothesis that e_1 is the identity morphism follows that the morphism f necessarily coincides with the morphism e_A . The tensor unit 1 is thus a terminal object of the category \mathbf{C} . This concludes the proof of Proposition 16. \square

Remark. The first hypothesis of Proposition 16 that (A, d_A, e_A) defines a comonoid may be replaced by the weaker hypothesis that the two diagrams

$$\begin{array}{ccc} A & \xrightarrow{d_A} & A \otimes A \\ \text{id} \downarrow & & \downarrow e_A \otimes A \\ A & \xleftarrow{\lambda} & 1 \otimes A \end{array} \quad \begin{array}{ccc} A & \xrightarrow{d_A} & A \otimes A \\ \text{id} \downarrow & & \downarrow A \otimes e_A \\ A & \xleftarrow{\rho} & A \otimes 1 \end{array}$$

commute for every object A . Observe indeed that coassociativity of the comultiplication law d_A is never used in the proof. This is essentially in this way that Albert Burroni formulated the result in his pioneering work on graphical algebras and recursivity [23].

Note moreover that one does not need to assume that the category $(\mathbf{C}, \otimes, 1)$ is *symmetric* monoidal nor that every object A defines a *commutative* comonoid, in order to state Proposition 16. However, the situation becomes nicely conceptual when the category $(\mathbf{C}, \otimes, 1)$ is equipped with a symmetry. In that case, indeed, the two endofunctors

$$X \mapsto X \otimes X \quad X \mapsto 1$$

on the category \mathbf{C} may be seen as lax monoidal endofunctors of the monoidal category $(\mathbf{C}, \otimes, 1)$. The coercions m of the functor $X \mapsto X \otimes X$ are defined in a similar fashion as the product of two monoids in Proposition 15:

$$\begin{array}{l} m^0 : \quad 1 \xrightarrow{\rho^{-1}=\lambda^{-1}} 1 \otimes 1 \\ \\ m_{A,B}^2 : \quad \begin{array}{ccc} (A \otimes B) \otimes (A \otimes B) & & (A \otimes A) \otimes (B \otimes B) \\ \alpha \downarrow & & \uparrow \alpha \\ A \otimes (B \otimes (A \otimes B)) & & A \otimes (A \otimes (B \otimes B)) \\ A \otimes \alpha^{-1} \downarrow & & \uparrow A \otimes \alpha \\ A \otimes ((B \otimes A) \otimes B) & \xrightarrow{A \otimes (\gamma \otimes B)} & A \otimes ((A \otimes B) \otimes B) \end{array} \end{array} \quad (60)$$

The coercion n of the functor $X \mapsto 1$ is defined as the identity $n^0 : 1 \rightarrow 1$ and the morphism $n^2 = \lambda_1 = \rho_1 : 1 \otimes 1 \rightarrow 1$. Note that the endofunctors $X \mapsto X \otimes X$ and $X \mapsto 1$ are strong and symmetric, but we do not care about this additional property here. The following result is folklore:

Corollary 17 *Let $(\mathbf{C}, \otimes, 1)$ be a symmetric monoidal category. The tensor product is a cartesian product and the tensor unit is a terminal object if and only if there exists a pair of monoidal natural transformations d and e with components*

$$d_A : A \rightarrow A \otimes A \quad e_A : A \rightarrow 1$$

defining a comonoid (A, d_A, e_A) for every object A .

Proof. The direction (\Rightarrow) is easy, and left as exercise to the reader. The other direction (\Leftarrow) is established by applying Proposition 16. To that purpose, we show that Diagram (57) commutes for all objects A and B , and that the component e_1 coincides with the identity. This is deduced by an elementary diagram chasing in which the assumption that d and e are monoidal is here to ensure that $e_1 = id$ and that the diagram

$$\begin{array}{ccc}
 A \otimes B & \xrightarrow{d_A \otimes d_B} & (A \otimes A) \otimes (B \otimes B) \\
 \downarrow id & & \downarrow \alpha \\
 & & A \otimes (A \otimes (B \otimes B)) \\
 & & \downarrow A \otimes \alpha^{-1} \\
 & & A \otimes ((A \otimes B) \otimes B) \\
 & & \downarrow A \otimes (\gamma \otimes B) \\
 & & A \otimes ((B \otimes A) \otimes B) \\
 & & \downarrow A \otimes \alpha \\
 & & A \otimes (B \otimes (A \otimes B)) \\
 & & \downarrow \alpha^{-1} \\
 A \otimes B & \xrightarrow{d_{A \otimes B}} & (A \otimes B) \otimes (A \otimes B)
 \end{array}$$

commutes for all objects A and B . \square

Remark. Note that the statement of Corollary 17 does not require the hypothesis that the comonoid (A, d_A, e_A) is commutative. It is also interesting to notice that the hypothesis of monoidality of the natural transformations d and e is only used in the binary case for d and in the nullary case for e . In particular, the proof does not require the nullary case for d which states that the equality $d_1 = \lambda_1$ holds. Similarly, it does not require the binary case for e which states that the

diagram

$$\begin{array}{ccc}
 & & 1 \otimes 1 \\
 & \nearrow^{e_A \otimes e_B} & \downarrow \lambda = \rho \\
 A \otimes B & & 1 \\
 & \searrow_{e_{A \otimes B}} &
 \end{array}$$

commutes for all object A and B .

6.5 The category of commutative comonoids

To every symmetric monoidal category $(\mathbf{C}, \otimes, 1)$, we associate the category $\mathbf{Comon}(\mathbf{C}, \otimes, 1)$

- with commutative comonoids as objects,
- with comonoid morphisms as morphisms.

The category $\mathbf{Comon}(\mathbf{C}, \otimes, 1)$ is symmetric monoidal with the monoidal structure defined in Proposition 15 in Section 6.2 dualized. We establish below that the tensor product is a cartesian product, and that the tensor unit is a terminal object in the category $\mathbf{Comon}(\mathbf{C}, \otimes, 1)$. This folklore property is deduced from Proposition 16.

Corollary 18 *The category $\mathbf{Comon}(\mathbf{C}, \otimes, 1)$ is cartesian.*

Proof. Once dualized, Proposition 15 in Section 6.2 states that the category $\mathbf{Comon}(\mathbf{C}, \otimes, 1)$ is symmetric monoidal. By definition, every object A of the category $\mathbf{Comon}(\mathbf{C}, \otimes, 1)$ is a commutative comonoid $A = (A, d_A, e_A)$ of the underlying symmetric monoidal category $(\mathbf{C}, \otimes, 1)$. This commutative comonoid lifts to a commutative comonoid in the symmetric monoidal category $\mathbf{Comon}(\mathbf{C}, \otimes, 1)$. This is precisely the content (once dualized) of the exercise appearing at the end of Section 6.2. Similarly, every morphism

$$f : A \longrightarrow B$$

in the category $\mathbf{Comon}(\mathbf{C}, \otimes, 1)$ defines a comonoid morphism

$$f : (A, d_A, e_A) \longrightarrow (B, d_B, e_B)$$

in the underlying monoidal category $(\mathbf{C}, \otimes, 1)$. From this follows that f is a comonoid morphism

$$f : (A, d_A, e_A) \longrightarrow (B, d_B, e_B)$$

in the monoidal category $\mathbf{Comon}(\mathbf{C}, \otimes, 1)$ itself. This proves that d and e are natural transformations in the category $\mathbf{Comon}(\mathbf{C}, \otimes, 1)$. Finally, the construction of the monoids 1 and $A \otimes B$ in Proposition 15 in Section 6.2 implies that,

once dualized, Diagram (57) commutes for all objects A and B , and that the morphism e_1 coincides with the identity. We apply Proposition 16 and conclude that in the category $\mathbf{Comon}(\mathbb{C}, \otimes, 1)$, the tensor product is a cartesian product, and the tensor unit is a terminal object. \square

Corollary 19 *A symmetric monoidal category $(\mathbb{C}, \otimes, 1)$ is cartesian if and only if the forgetful functor*

$$U : \mathbf{Comon}(\mathbb{C}, \otimes, 1) \longrightarrow \mathbb{C}$$

defines an isomorphism of categories.

Exercise. By isomorphism of categories, we mean a functor U with an inverse, that is, a functor V such that the two composite functors $U \circ V$ and $V \circ U$ are the identity. Suppose that the functor (U, m) is strong monoidal and symmetric between symmetric monoidal categories — as this is the case in Corollary 19. Show that the inverse functor V lifts as a strong monoidal and symmetric functor (V, n) such that $(U, m) \circ (V, n)$ and $(V, n) \circ (U, m)$ are the identity functors, with trivial coercions. [Hint: use the fact that V is at the same time left and right adjoint to the functor U , with trivial unit η and counit ε , and apply Proposition 14 in Section 5.17, Chapter 5.] \blacksquare

Exercise. Establish the following universality property of the forgetful functor U above, understood as a symmetric and strict monoidal functor (U, p) whose coercion maps p are provided by identities. Show that for every oplax monoidal functor

$$(F, m) : (\mathbb{D}, \times, e) \longrightarrow (\mathbb{C}, \otimes, 1)$$

from a cartesian category (\mathbb{D}, \times, e) to a symmetric monoidal category $(\mathbb{C}, \otimes, 1)$ there exists a unique symmetric oplax monoidal functor

$$(G, n) : (\mathbb{D}, \times, e) \longrightarrow \mathbf{Comon}(\mathbb{C}, \otimes, 1)$$

making the diagram of symmetric oplax monoidal functors

$$\begin{array}{ccc} (\mathbb{D}, \times, e) & \xrightarrow{(G, n)} & \mathbf{Comon}(\mathbb{C}, \otimes, 1) \\ \parallel & & \downarrow (U, p) \\ (\mathbb{D}, \times, e) & \xrightarrow{(F, m)} & (\mathbb{C}, \otimes, 1) \end{array}$$

commute. \blacksquare

6.6 Monads and comonads

A monad $T = (T, \mu, \eta)$ in a category \mathbb{C} consists of a functor

$$T : \mathbb{C} \longrightarrow \mathbb{C}$$

and two natural transformations

$$\mu : T \circ T \Rightarrow T \qquad \eta : I \Rightarrow T$$

making the *associativity* diagram

$$\begin{array}{ccc} T^3 & \xrightarrow{T\mu} & T^2 \\ \downarrow \mu T & & \downarrow \mu \\ T^2 & \xrightarrow{\mu} & T \end{array}$$

and the two *unit* diagrams

$$\begin{array}{ccccc} IT & \xrightarrow{\eta T} & T^2 & \xleftarrow{T\eta} & TI \\ & \searrow id_T & \downarrow \mu & \swarrow id_T & \\ & & T & & \end{array}$$

commute, where I denotes the identity functor on the category \mathbf{C} .

Exercise. Show that the category $\mathbf{Cat}(\mathbf{C}, \mathbf{C})$ of endofunctors on a category \mathbf{C}

- with functors $F : \mathbf{C} \rightarrow \mathbf{C}$ as objects,
- with natural transformations $\theta : F \Rightarrow G$ as morphisms,

defines a strict monoidal category in which

- the product $F \otimes G$ of two functors is defined as their composite $F \circ G$,
- the unit e is defined as the identity functor on the category \mathbf{C} .

Show that a monad on the category \mathbf{C} is the same thing as a monoid in the monoidal category $(\mathbf{Cat}(\mathbf{C}, \mathbf{C}), \circ, I)$. ■

Dually, a comonad (K, δ, ε) in a category \mathbf{C} consists of a functor

$$K : \mathbf{C} \rightarrow \mathbf{C}$$

and two natural transformations

$$\delta : K \Rightarrow K \circ K \qquad \varepsilon : K \Rightarrow I$$

making the *associativity* diagram

$$\begin{array}{ccc} K & \xrightarrow{\delta} & K^2 \\ \downarrow \delta & & \downarrow K\delta \\ K^2 & \xrightarrow{\delta K} & K^3 \end{array}$$

and the two *unit* diagrams

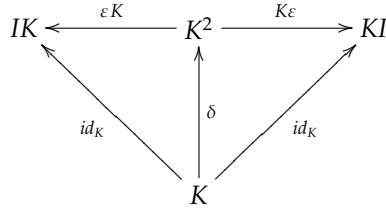

commute. We take this opportunity to indicate how these equalities would be depicted in the language of string diagrams.

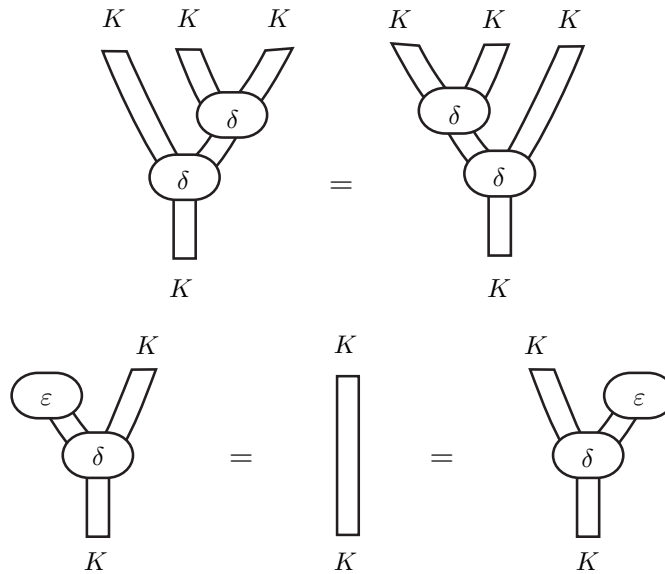

Exercise. Show that a comonad on a category \mathbf{C} is the same thing as a comonoid in its monoidal category $(\mathbf{Cat}(\mathbf{C}, \mathbf{C}), \circ, I)$ of endofunctors. ■

Exercise. Every object A in a monoidal category (\mathbf{C}, \otimes, e) defines a functor

$$X \mapsto A \otimes X \quad : \quad \mathbf{C} \longrightarrow \mathbf{C}.$$

Show that this defines a strong monoidal functor from the monoidal category (\mathbf{C}, \otimes, e) to its monoidal category $(\mathbf{Cat}(\mathbf{C}, \mathbf{C}), \circ, I)$ of endofunctors. Deduce that every monoid (A, m, u) in the monoidal category (\mathbf{C}, \otimes, e) defines in this way a monad (T, μ, η) on the category \mathbf{C} ; and dually, that every comonoid (A, d, e) defines in this way a comonad (K, δ, ε) on the category \mathbf{C} . ■

We have seen that a monad (resp. a comonad) over a category \mathbf{C} is a monoid (resp. a comonoid) in the monoidal category $\mathbf{Cat}(\mathbf{C}, \mathbf{C})$ of endofunctors and natural transformations. This leads to a generic notion of monad and comonad in a 2-category, developed in Section 6.9.

6.7 Monads and adjunctions

Every adjunction

$$\mathbf{C} \begin{array}{c} \xrightarrow{F_*} \\ \perp \\ \xleftarrow{F^*} \end{array} \mathbf{D} \quad (61)$$

induces a monad (T, μ, η) on the category \mathbf{C} and a comonad (K, δ, ε) on the category \mathbf{D} , in which the functors T and K are the composites:

$$T = F^* \circ F_* \qquad K = F_* \circ F^*$$

and the two natural transformations

$$\eta : 1_{\mathbf{C}} \Rightarrow F^* \circ F_* \qquad \varepsilon : F_* \circ F^* \Rightarrow 1_{\mathbf{D}}$$

are constructed as explained in Section 5.12 of Chapter 5. Here, we use the notation $1_{\mathbf{C}}$ for the identity functor of the category \mathbf{C} . The two natural transformations μ and δ are then deduced from η and ε by composition:

$$\begin{aligned} \mu = F^* \circ \varepsilon \circ F_* & : F^* \circ F_* \circ F^* \circ F_* \Rightarrow F^* \circ F_* \\ \delta = F_* \circ \eta \circ F^* & : F_* \circ F^* \Rightarrow F_* \circ F^* \circ F_* \circ F^* \end{aligned}$$

We leave the reader to check that, indeed, we have defined a monad (T, μ, η) and a comonad (K, δ, ε) . The proof follows from the triangular equalities formulated in Chapter 5 (Section 5.12). It may also be performed at a more abstract 2-categorical level, as will be explored in Section 6.9.

Conversely, given a monad (T, μ, η) on the category \mathbf{C} , does there exist an adjunction (61) whose induced monad on the category \mathbf{C} coincides precisely with the monad (T, μ, η) . The answer happens to be positive, and positive twice: there exists indeed two different canonical ways to construct such an adjunction, each one based on a specific category \mathbf{C}_T and \mathbf{C}^T .

$$\mathbf{C} \begin{array}{c} \xrightarrow{F_*} \\ \perp \\ \xleftarrow{F^*} \end{array} \mathbf{C}_T \qquad \mathbf{C} \begin{array}{c} \xrightarrow{G_*} \\ \perp \\ \xleftarrow{G^*} \end{array} \mathbf{C}^T$$

The two categories are called:

- the Kleisli category \mathbf{C}_T of the monad,
- the Eilenberg-Moore category \mathbf{C}^T of the monad.

The construction of the two categories \mathbf{C}_T and \mathbf{C}^T will be readily found in any textbook on category theory, like Saunders Mac Lane's monograph [66] or Francis Borceux's Handbook of Categorical Algebra [22]. However, we will define them in turn here. The reason is that, once dualized and adapted to comonads, the two categories \mathbf{C}_T and \mathbf{C}^T play a central role in the semantics of proofs in linear logic – as we will emphasized in our next Chapter 7.

The Kleisli category \mathbf{C}_T has

transports every object A of the Kleisli category \mathbf{C}_T to the object TA of the category \mathbf{C} , and every morphism

$$f : A \rightarrow B$$

in the category \mathbf{C}_T understood as a morphism

$$f : A \rightarrow TB$$

in the category \mathbf{C} , to the morphism

$$F^*(f) = TA \xrightarrow{Tf} T^2B \xrightarrow{\mu} TB$$

in the category \mathbf{C} . The left adjoint functor

$$\mathbf{C} \xrightarrow{F_*} \mathbf{C}_T$$

transports every object A of category \mathbf{C} to the same object A of the Kleisli category \mathbf{C}_T ; and every every morphism

$$f : A \rightarrow B$$

in the category \mathbf{C} , to the morphism

$$F_*(f) : A \xrightarrow{f} B \xrightarrow{\eta_B} TB$$

in the category \mathbf{C} , understood as a morphism $A \rightarrow B$ in the category \mathbf{C}_T .

The Eilenberg-Moore category \mathbf{C}^T has

- the algebras of the monad (T, μ, η) as objects,
- the algebra morphisms as morphisms.

An algebra of the monad (T, μ, η) is defined as a pair (A, h) consisting of an object A of the category \mathbf{C} , and a morphism

$$h : TA \rightarrow A$$

making the two diagrams

$$\begin{array}{ccc} & TA & \\ \eta_A \nearrow & & \searrow h \\ A & \xrightarrow{id} & A \end{array}$$

$$\begin{array}{ccc} T^2A & \xrightarrow{\mu_A} & TA \\ Th \downarrow & & \downarrow h \\ TA & \xrightarrow{h} & A \end{array}$$

commute in the category \mathbf{C} . An algebra morphism

$$f : (A, h_A) \longrightarrow (B, h_B)$$

is defined as a morphism $f : A \longrightarrow B$ between the underlying objects in the category \mathbf{C} , making the diagram

$$\begin{array}{ccc} TA & \xrightarrow{Tf} & TB \\ h_A \downarrow & & \downarrow h_B \\ A & \xrightarrow{f} & B \end{array}$$

commute. The right adjoint functor

$$\mathbf{C}^T \xrightarrow{G_*} \mathbf{C}$$

is called the *forgetful functor*. It transports every algebra (A, h) to the underlying object A , and every algebra morphism

$$f : (A, h_A) \longrightarrow (B, h_B)$$

to the underlying morphism $f : A \longrightarrow B$. The left adjoint functor

$$\mathbf{C} \xrightarrow{G^*} \mathbf{C}^T$$

is called the *free functor*. It transports every object A to the algebra

$$\mu_A : T^2A \longrightarrow TA$$

This algebra (TA, μ_A) is called the *free algebra* associated to the object A . Every morphism $f : A \longrightarrow B$ of the category \mathbf{C} is transported by the functor G_* to the algebra morphism

$$Tf : (TA, \mu_A) \longrightarrow (TB, \mu_B).$$

Exercise. Check that the pair (TA, μ_A) defines indeed an algebra of the monad (T, μ, η) ; and that the morphism $Tf : TA \longrightarrow TB$ defines an algebra morphism between the free algebras (TA, μ_A) and (TB, μ_B) . ■

Exercise. Show that the morphisms

$$f : A \longrightarrow B$$

of the Kleisli category \mathbf{C}_T may be alternatively defined as the morphisms

$$f : TA \longrightarrow TB$$

of the underlying category \mathbf{C} making the diagram

$$\begin{array}{ccc}
 T^2A & \xrightarrow{Tf} & T^2B \\
 \mu_A \downarrow & & \downarrow \mu_B \\
 TA & \xrightarrow{f} & TB
 \end{array}$$

commute. Reformulate in this setting the composition law previously defined for the Kleisli category \mathbf{C}_T . Deduce that there exists a full and faithful functor from the Kleisli category \mathbf{C}_T to the category \mathbf{C}^T of Eilenberg-Moore algebras, transporting every object A to its free algebra (TA, μ_A) . This formulation enables to see the Kleisli category \mathbf{C}_T as a category of *free algebras* for the monad (T, μ, η) . ■

It is folklore in category theory that:

- the adjunction $F_* \dashv F^*$ based on the Kleisli category \mathbf{C}_T is *initial* among all the possible “factorizations” of the monad (T, δ, ε) as an adjunction,
- the adjunction $G_* \dashv G^*$ based on the Eilenberg-Moore category \mathbf{C}^T is *terminal* among all the possible “factorizations” of the monad (T, δ, ε) as an adjunction.

We will not develop this point here, although it is a fundamental aspect of the topic. The interested reader will find a nice exposition of the theory in Mac Lane’s monograph [66].

6.8 Comonads and adjunctions

Because we are mainly interested in the categorical semantics of linear logic, we will generally work with a comonad (K, δ, ε) on a category \mathbf{C} of proof invariants, instead of a monad (T, μ, η) . This does not matter really, since a comonad on the category \mathbf{C} is the same thing as a monad on the opposite category \mathbf{C}^{op} . Consequently, the two constructions of a Kleisli category \mathbf{C}_T and of an Eilenberg-Moore category \mathbf{C}^T for a monad, dualize to:

- a Kleisli category \mathbf{C}_K ,
- a category \mathbf{C}^K of Eilenberg-Moore coalgebras

for the comonad (K, δ, ε) with the expected derived adjunctions:

$$\begin{array}{ccc}
 \mathbf{C}_K & \begin{array}{c} \xrightarrow{F_*} \\ \perp \\ \xleftarrow{F^*} \end{array} & \mathbf{C} \\
 \mathbf{C}^K & \begin{array}{c} \xrightarrow{G_*} \\ \perp \\ \xleftarrow{G^*} \end{array} & \mathbf{C}
 \end{array}$$

The Kleisli category \mathbb{C}_K has:

- the objects of the category \mathbb{C} as objects,
- the morphisms $KA \rightarrow B$ as morphisms $A \rightarrow B$.

The Eilenberg-Moore category \mathbb{C}^K has

- the coalgebras of the comonad (K, δ, ε) as objects,
- the coalgebra morphisms as morphisms.

A coalgebra of the comonad (K, δ, ε) is defined as a pair (A, h) consisting of an object A of the category \mathbb{C} , and a morphism

$$h : A \rightarrow KA$$

making the two diagrams

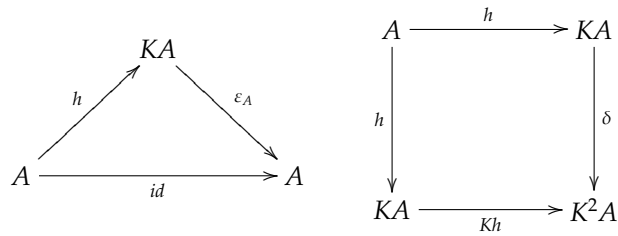

commute in the category \mathbb{C} . A coalgebra morphism

$$f : (A, h_A) \rightarrow (B, h_B)$$

is defined as a morphism $f : A \rightarrow B$ between the underlying objects in the category \mathbb{C} , making the diagram

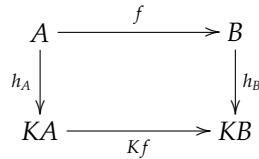

commute.

6.9 Symmetric monoidal comonads

The notion of symmetric monoidal comonad plays a central role in the definition of a linear category, the third axiomatization of linear logic presented in Chapter 7. Instead of explaining the notion directly, we proceed as in Chapter 5 and define on the first hand a generic definition of comonad (k, δ, ε) over an object C in a 2-category \mathcal{C} . This 2-categorical definition of comonad generalizes

the definition of comonad exposed previously: indeed, a comonad in the sense of Section 6.6 is the same thing as a comonad in the 2-category **Cat** of categories, functors, and natural transformations. A symmetric monoidal comonad is then defined as a comonad in the 2-category **SymMonCat** of symmetric monoidal categories, lax monoidal functors, and monoidal natural transformations, introduced in Proposition 10, at the end of Section 5.9.

The general definition of a comonad in a 2-category is nice and conceptual. Every object C in a 2-category \mathcal{C} induces a strict monoidal category $\mathcal{C}(C, C)$ with objects the horizontal morphisms

$$f : C \rightarrow C$$

with morphisms the cells

$$\theta : f \Rightarrow g : C \rightarrow C$$

and with monoidal structure provided by horizontal composition in the 2-category \mathcal{C} . A *comonad* on the object C is then simply defined as a comonoid of this monoidal category $\mathcal{C}(C, C)$. This elegant and concise definition may be expounded in the following way. A comonad on the object C is the same thing as a triple (k, ε, δ) consisting of a horizontal morphism

$$k : C \rightarrow C$$

and two vertical cells ε and δ depicted as

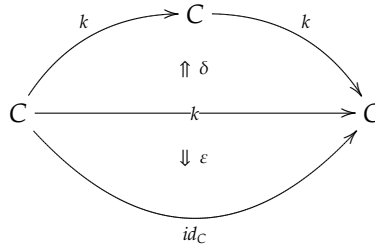

satisfying the following equalities, expressing associativity:

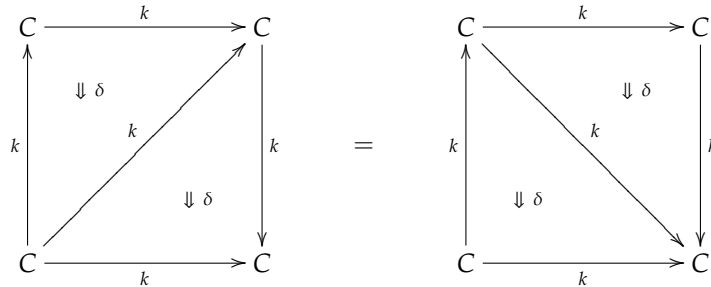

and the two unit laws:

$$\begin{array}{c}
\begin{array}{ccc}
C & \xrightarrow{k} & C \\
\downarrow \varepsilon & & \downarrow \delta \\
C & \xrightarrow{k} & C \\
id_C & &
\end{array}
\begin{array}{c}
\curvearrowright \\
\downarrow \\
\curvearrowleft
\end{array}
=
\begin{array}{ccc}
C & & C \\
& \downarrow 1^k & \\
& \curvearrowright & \curvearrowleft \\
& k &
\end{array}
=
\begin{array}{ccc}
C & \xrightarrow{k} & C \\
& & \downarrow \varepsilon \\
& & C \\
& & \downarrow \delta \\
& & C \\
& & \downarrow \varepsilon \\
& & C \\
& & id_C
\end{array}
\end{array}$$

A monad on the object C is defined in a similar fashion, as a monoid in the monoidal category $\mathcal{C}(C, C)$.

Exercise. Show that every adjunction $f_* \dashv f^*$ between morphisms $f_* : C \rightarrow D$ and $f^* : D \rightarrow C$ in a 2-category \mathcal{C} induces a monad on the object C and a comonad on the object D . ■

The converse statement is studied next section.

6.10 Symmetric monoidal comonads and adjunctions

Every adjunction in a 2-category \mathcal{C} induces a monad and a comonad in the 2-categorical sense. Conversely, we have seen in Section 6.6 that every comonad K over a category \mathbf{C} induces two particular adjunctions:

1. an adjunction with the Kleisli category \mathbf{C}_K ,
2. an adjunction with the category of Eilenberg-Moore coalgebras \mathbf{C}^K .

Besides, the comonad associated to each adjunction is precisely the comonad K .

This well-known fact about comonads in the 2-category \mathbf{Cat} is not necessarily true in an arbitrary 2-category \mathcal{C} . In particular, the statement becomes only half-true (and thus, half-false) for a comonad in the 2-category $\mathbf{SymMonCat}$. It is worth clarifying this important point here. Consider the forgetful 2-functor

$$U : \mathbf{SymMonCat} \rightarrow \mathbf{Cat}$$

which transports every symmetric monoidal category to its underlying category. Because this operation is 2-functorial, it transports every comonad K in $\mathbf{SymMonCat}$ to a comonad UK in \mathbf{Cat} . This comonad UK generates two adjunctions in \mathbf{Cat} , one for each of the two categories \mathbf{C}_{UK} and \mathbf{C}^{UK} . The question is whether each of these two adjunctions in \mathbf{Cat} lifts to adjunctions in $\mathbf{SymMonCat}$.

It appears that it is not necessarily the case: a general 2-categorical argument developed by Stephen Lack in [62] demonstrates that the adjunction with the category \mathbf{C}^{UK} of Eilenberg-Moore coalgebras lifts to an adjunction

in **SymMonCat**

$$\begin{array}{ccc}
 & (L,m) & \\
 & \curvearrowright & \\
 (\mathbf{C}^K, \otimes^K, 1) & \perp & (\mathbf{C}, \otimes, 1) \\
 & \curvearrowleft & \\
 & (M,n) &
 \end{array} \quad (62)$$

whereas the adjunction with the Kleisli category \mathbf{C}_{UK} does not necessarily lift to an adjunction in **SymMonCat**. In the symmetric monoidal adjunction (62), the category $\mathbf{C}^{UK} = \mathbf{C}^K$ is equipped with the symmetric monoidal structure:

$$\begin{array}{ccc}
 A & & A \otimes B \\
 \downarrow h_A & \otimes^K & \downarrow h_A \otimes h_B \\
 KA & & KA \otimes KB \\
 & & \downarrow m_{A,B} \\
 & & K(A \otimes B)
 \end{array} = \begin{array}{ccc}
 & & 1 \\
 & & \downarrow m^0 \\
 & & K1
 \end{array} \quad (63)$$

On the other hand, the adjunction between \mathbf{C} and its Kleisli category \mathbf{C}_K does not lift in general to a symmetric monoidal adjunction. However, we may proceed dually, and define an *oplax* symmetric monoidal comonad as a comonad in the 2-category **SymOplaxMonCat** of symmetric monoidal categories, *oplax* monoidal functors, and monoidal natural transformations introduced in Proposition 11, at the very end of Section 5.9. Interestingly, the same 2-categorical argument by Stephen Lack applies by duality, and shows that (dually to the previous case) the adjunction with the Kleisli category \mathbf{C}_{UK} lifts to an adjunction in **SymOplaxMonCat**

$$\begin{array}{ccc}
 & (L,m) & \\
 & \curvearrowright & \\
 (\mathbf{C}_K, \otimes_K, 1) & \perp & (\mathbf{C}, \otimes, 1) \\
 & \curvearrowleft & \\
 & (M,n) &
 \end{array}$$

whereas the adjunction between \mathbf{C} and its Eilenberg-Moore category \mathbf{C}^K does not lift in general to such a symmetric *oplax* monoidal adjunction. Here, the monoidal structure of the category \mathbf{C} lifts to the Kleisli category \mathbf{C}_K of the symmetric oplax monoidal comonad $((K, n), \delta, \varepsilon)$ in the following way. Every pair of morphisms

$$f : A \longrightarrow A' \quad \text{and} \quad g : B \longrightarrow B'$$

in the category \mathbf{C}_K may be seen alternatively as a pair of morphisms

$$f : KA \longrightarrow A' \quad \text{and} \quad g : KB \longrightarrow B'$$

in the category \mathbf{C} . The morphism $f \otimes_K g$ in the category \mathbf{C}_K is defined as the morphism

$$f \otimes_K g \quad : \quad K(A \otimes B) \xrightarrow{\eta_{A,B}^2} (KA \otimes KB) \xrightarrow{f \otimes g} A' \otimes B' \quad (64)$$

in the category \mathbf{C} .

6.11 A useful property of retractions between coalgebras

In this section, we suppose given a comonad (K, μ, η) on a category \mathbf{C} . We also suppose given two coalgebras (A, h_A) and (B, h_B) and a retraction

$$A \xrightarrow{i} B \xrightarrow{r} A = A \xrightarrow{id_A} A$$

between the underlying objects. We establish the following useful property.

Proposition 20 *Suppose that i is a coalgebra morphism*

$$i \quad : \quad (A, h_A) \longrightarrow (B, h_B).$$

Then, for every coalgebra (X, h_X) and morphism

$$f \quad : \quad X \longrightarrow A$$

the two following statements are equivalent:

- *the morphism f is a coalgebra morphism*

$$f \quad : \quad (X, h_X) \longrightarrow (A, h_A)$$

- *the composite morphism $i \circ f$ is a coalgebra morphism*

$$i \circ f \quad : \quad (X, h_X) \longrightarrow (B, h_B).$$

Proof. The direction (\Rightarrow) is immediate: the morphism $i \circ f$ the composite of two coalgebra morphisms when f is a coalgebra morphism. As such, it is a coalgebra morphism. The direction (\Leftarrow) is less obvious to establish. Suppose that $i \circ f$ is a coalgebra morphism. This means that the diagram

$$\begin{array}{ccccc} X & \xrightarrow{f} & A & \xrightarrow{i} & B \\ \downarrow h_X & & & & \downarrow h_B \\ KX & \xrightarrow{Kf} & KA & \xrightarrow{Ki} & KB \end{array} \quad (65)$$

commutes. From this follows that the diagram

$$\begin{array}{ccccc}
 X & \xrightarrow{f} & A & \xrightarrow{i} & B \\
 \downarrow h_X & & & & \downarrow h_B \\
 KX & \xrightarrow{Kf} & KA & \xleftarrow{Kr} & KB
 \end{array} \tag{66}$$

commutes, by post-composing with Kr and applying the equality

$$Kr \circ Ki = K(r \circ i) = id_{KA}.$$

At this point, one applies the hypothesis that the morphism i is a coalgebra morphism, and consequently, that the diagram

$$\begin{array}{ccc}
 A & \xrightarrow{i} & B \\
 \downarrow h_A & & \downarrow h_B \\
 KA & \xrightarrow{Ki} & KB
 \end{array}$$

commutes. This implies that the diagram

$$\begin{array}{ccc}
 A & \xrightarrow{i} & B \\
 \downarrow h_A & & \downarrow h_B \\
 KA & \xleftarrow{Kr} & KB
 \end{array} \tag{67}$$

by applying the same recipe as previously to deduce Diagram (66) from Diagram (65). Putting together Diagram (66) and Diagram (67) one obtains that the diagram

$$\begin{array}{ccc}
 X & \xrightarrow{f} & A \\
 \downarrow h_X & & \downarrow h_A \\
 KX & \xrightarrow{Kf} & KA
 \end{array}$$

commutes. This establishes that the morphism f is a coalgebra morphism. \square

Remark. Proposition 20 may be reformulated as a lifting property of the coalgebra morphism i . The lifting property states that every coalgebra morphism

$$g : (X, h_X) \longrightarrow (B, h_B)$$

lifts as a morphism f along the morphism i in the category \mathbf{C}^K of Eilenberg-Moore coalgebras, when it lifts as the morphism f along the morphism i in the underlying category \mathbf{C} . Diagrammatically, this means that every time a diagram

$$\begin{array}{ccc} & (X, h_X) & \\ & \searrow g & \\ (A, h_A) & \xrightarrow{i} & (B, h_B) \end{array}$$

in the category \mathbf{C}^K of Eilenberg-Moore coalgebras is transported by the forgetful functor to the fragment of a commuting diagram

$$\begin{array}{ccc} & X & \\ f \swarrow & & \searrow g \\ A & \xrightarrow{i} & B \end{array} \quad (68)$$

in the category \mathbf{C} , the original diagram may be also completed as a commuting diagram

$$\begin{array}{ccc} & (X, h_X) & \\ f \swarrow & & \searrow g \\ (A, h_A) & \xrightarrow{i} & (B, h_B) \end{array} \quad (69)$$

in the category \mathbf{C}^K of Eilenberg-Moore coalgebras. Furthermore, the resulting Diagram (69) is transported to the Diagram (68) by the forgetful functor — this simply meaning in this case that the morphism f obtained by lifting g along i is a coalgebra morphism.

7 Categorical models of linear logic

We review here three alternative categorical semantics of linear logic: Lafont categories, Seely categories, and Linear categories. We show that, in each case, the axiomatization induces a *symmetric monoidal adjunction*

$$(L, m) \dashv (M, n)$$

between the symmetric monoidal closed category of denotations \mathbb{L} and a specific cartesian category \mathbb{M} . The reader starting at this point will find in Section 5.17 of Chapter 5 the definition and characterization of a symmetric monoidal adjunction.

Definition 21 *A linear-non-linear adjunction is a symmetric monoidal adjunction between lax symmetric monoidal functors*

$$\begin{array}{ccc}
 & \xrightarrow{(L,m)} & \\
 (\mathbb{M}, \times, e) & \perp & (\mathbb{L}, \otimes, 1) \\
 & \xleftarrow{(M,n)} &
 \end{array} \tag{70}$$

in which the category \mathbb{M} is equipped with a cartesian product \times and a terminal object e .

The notations L and M are mnemonics for *Linearization* and *Multiplication*. Informally, the functor M transports a *linear* proof — which may be used exactly once as hypothesis in a reasoning — to a *multiple* proof — which may be repeated or discarded. Conversely, the functor L transports a *multiple* proof to a *linear* proof — which may then be manipulated as a linear entity inside the symmetric monoidal closed category \mathbb{L} .

This categorical machinery captures the essence of linear logic: it works just like a weaving loom, producing the linguistic texture of proofs by back and forth application of the functors L and M , all the logical rules occurring in L , all the structural rules occurring in M . The exponential modality $!$ of linear logic is then interpreted as the *comonad* on the category \mathbb{L} defined by composing the two functors of the adjunction:

$$! = L \circ M.$$

This factorization of the modality is certainly one of the most interesting aspects of the categorical semantics of linear logic: we will start the chapter by studying in Section 7.1 one of its noteworthy effects.

Seen from that point of view, each categorical semantics of linear logic provides a particular recipe to construct a cartesian category (\mathbb{M}, \times, e) and a monoidal adjunction $(L, m) \dashv (M, n)$ starting from the symmetric monoidal category (\mathbb{L}, \otimes, e) :

- Lafont category: the category \mathbb{M} is defined as the category $\mathbf{Comon}(\mathbb{L}, \otimes, e)$ with commutative comonoids of the category (\mathbb{L}, \otimes, e) as objects, and comonoid morphisms between them as morphisms,

- Seely category: the category \mathbb{M} is defined as the Kleisli category $\mathbb{L}_!$ associated to the comonad $!$ which equips the category \mathbb{L} in the definition of a Seely category (here, one needs to replace Seely's original definition by the definition of a new-Seely category advocated by Bierman in [16]).
- Linear category: the category \mathbb{M} is defined as the category $\mathbb{L}^!$ of Eilenberg-Moore coalgebras associated to the symmetric monoidal comonad $!$ which equips the category \mathbb{L} in the definition of a Linear category.

We recall here how symmetric monoidal adjunctions are characterized by Proposition 14 in Section 5.17 of Chapter 5: an adjunction between functors

$$L \dashv M$$

lifts to a symmetric monoidal adjunction

$$(L, m) \dashv (M, n)$$

if and only if the monoidal functor

$$(L, m) : (\mathbb{M}, \times, e) \longrightarrow (\mathbb{L}, \otimes, 1)$$

is symmetric and strong monoidal. The purpose of each axiomatization of linear logic is thus to provide what is missing (not much!) to be in such a situation.

- Lafont category: the category $\mathbb{M} = \mathbf{Comon}(\mathbb{L}, \otimes, e)$ associated to a given symmetric monoidal category (\mathbb{L}, \otimes, e) is necessarily cartesian; and the forgetful functor L from $\mathbf{Comon}(\mathbb{L}, \otimes, e)$ to (\mathbb{L}, \otimes, e) is strict monoidal and symmetric. Thus, the only task of Lafont's axiomatization is to ensure that the forgetful functor L has a right adjoint M .
- Seely category: given a comonad $(!, \varepsilon, \delta)$ on the category \mathbb{L} , there exists a canonical adjunction $L \dashv M$ between the category \mathbb{L} and its Kleisli category $\mathbb{M} = \mathbb{L}_!$. Moreover, since the category \mathbb{L} is supposed to be cartesian in the definition of a Seely category, its Kleisli category $\mathbb{L}_!$ is necessarily cartesian. The only task of the axiomatization is thus to ensure that the functor L is strong monoidal and symmetric.
- Linear category: given a symmetric monoidal comonad $(!, \varepsilon, \delta, p)$ on the symmetric monoidal category (\mathbb{L}, \otimes, e) , there exists a canonical symmetric monoidal adjunction $(L, m) \dashv (M, n)$ between the symmetric monoidal category (\mathbb{L}, \otimes, e) and its category $\mathbb{M} = \mathbb{L}^!$ of Eilenberg-Moore coalgebras. The category $\mathbb{L}^!$ is equipped with the symmetric monoidal structure induced from (\mathbb{L}, \otimes, e) . The only task of the axiomatization is thus to ensure that this symmetric monoidal structure on the category $\mathbb{L}^!$ defines a cartesian category.

The reader will find the notions of symmetric monoidal comonad, of Kleisli category, and of category of Eilenberg-Moore coalgebras, introduced in the course of Chapter 5 and Chapter 6.

7.1 The transmutation principle of linear logic

One fundamental principle formulated by Jean-Yves Girard in his original article on linear logic [40] states that the exponential modality $!$ transports (or *transmutes* in the language of alchemy) the additive connective $\&$ and its unit \top into the multiplicative connective \otimes and its unit 1 . This means formally that there exists a pair of isomorphisms

$$!A \otimes !B \cong !(A \& B) \quad 1 \cong !\top \quad (71)$$

for every formula A and B of linear logic.

Quite remarkably, the existence of these isomorphisms may be derived from purely categorical principles, starting from the slightly enigmatic factorization of the exponential modality as

$$! = L \circ M.$$

We find useful to start the chapter on this topic, because it demonstrates the beauty and elegance of categorical semantics. At the same time, this short discussion will provide us with a categorical explanation (instead of a proof-theoretic one) for the apparition of the isomorphisms (71) in any *cartesian* category of denotations \mathbb{L} — and will clarify the intrinsic nature and properties of these isomorphisms.

In order to interpret the additive connective $\&$ and unit \top of linear logic, we suppose from now on that the category of denotations \mathbb{L} is cartesian, with:

- the cartesian product of a pair of objects A and B noted $A \& B$,
- the terminal object noted \top .

We took the opportunity of the series of exercises at the end of Section 5.2, of Section 5.5 and of Section 5.6, to establish the two remarkable facts below:

Proposition 22 *The two following statements hold:*

- every functor F between cartesian categories lifts as a symmetric oplax monoidal functor (F, j) in a unique way,
- every natural transformation between two such symmetric oplax monoidal functors is monoidal.

From this, it follows easily that the adjunction

$$\begin{array}{ccc} & L & \\ \mathbb{M} & \begin{array}{c} \curvearrowright \\ \perp \\ \curvearrowleft \end{array} & \mathbb{L} \\ & M & \end{array}$$

lifts as a *symmetric* and *oplax monoidal* adjunction:

$$\begin{array}{ccc}
& \xrightarrow{(L,j)} & \\
(\mathbb{M}, \times, e) & \perp & (\mathbb{L}, \&, \top) \\
& \xleftarrow{(M,k)} &
\end{array}$$

between the cartesian categories (\mathbb{M}, \times, e) and $(\mathbb{L}, \&, \top)$ seen as symmetric monoidal categories. By symmetric *oplax* monoidal adjunction, we mean an adjunction in the 2-category **SymOplaxMonCat** defined in Proposition 11, at the very end of Section 5.9. By duality, such an adjunction is characterized in Proposition 14 of Section 5.17 as an adjunction in which the *right adjoint functor* (M, k) is strong monoidal and symmetric. By this slightly sinuous path, we get another proof of the well-known principle that right adjoint functors preserve limits (in that case, the cartesian products and the terminal object) modulo isomorphism.

Thus, taken separately, each of the two functors appearing in the symmetric monoidal adjunction

$$(\mathbb{L}, \&, \top) \xrightarrow{(M,k)} (\mathbb{M}, \times, e) \xrightarrow{(L,m)} (\mathbb{L}, \otimes, e)$$

is strong monoidal and symmetric. From this follows that their composite

$$(!, p) = (L, m) \circ (M, k) \quad : \quad (\mathbb{L}, \&, \top) \longrightarrow (\mathbb{L}, \otimes, e)$$

is also strong monoidal and symmetric. By the definition of such a functor, the monoidal structure p defines a pair of isomorphisms

$$p_{A,B}^2 : !A \otimes !B \xrightarrow{\cong} !(A \& B) \quad p^0 : 1 \xrightarrow{\cong} !\top$$

natural in the objects A and B of the category \mathbb{L} , and satisfying the coherence axioms formulated in Section 5.1 and Section 5.6.

7.2 Lafont categories

A *Lafont category* is defined as a symmetric monoidal closed category $(\mathbb{L}, \otimes, 1)$ in which the forgetful functor

$$U : \text{Comon}(\mathbb{L}, \otimes, 1) \longrightarrow \mathbb{L}$$

has a right adjoint. In that case, the right adjoint functor $!$ is called a free construction, because it associates the *free* commutative comonoid $!A$ to any object A of the category \mathbb{L} .

Equivalently, a Lafont category is defined as a symmetric monoidal closed category $(\mathbb{L}, \otimes, 1)$ in which there exists for every object A of the category, a commutative comonoid

$$!A = (!A, d_A, e_A)$$

and a morphism

$$\varepsilon_A : !A \longrightarrow A$$

satisfying the following universality property: for every commutative comonoid

$$X = (X, d, e)$$

and for every morphism

$$f = X \longrightarrow A$$

there exists a *unique* comonoid morphism

$$f^\dagger : (X, d, e) \longrightarrow (!A, d_A, e_A)$$

making the diagram

$$\begin{array}{ccc} & & !A \\ & \nearrow^{f^\dagger} & \downarrow \varepsilon_A \\ X & & A \\ & \searrow_f & \end{array}$$

commute in the category \mathbb{L} . The statement of Proposition 15 originally formulated for commutative monoids in Section 6.2 may be adapted by duality to commutative comonoids. The resulting proposition states that the forgetful functor U is strict monoidal and symmetric. From this and Proposition 14 follows that the adjunction $U \dashv !$ between the forgetful functor and the free construction lifts to a symmetric monoidal adjunction:

$$\begin{array}{ccc} & \xrightarrow{(L,m)} & \\ \text{Comon}(\mathbb{L}, \otimes, 1), \otimes, 1 & \perp & (\mathbb{L}, \otimes, 1) \\ & \xleftarrow{(M,n)} & \end{array}$$

where the functor L is defined as the forgetful functor U from the category $\text{Comon}(\mathbb{L}, \otimes, 1)$ of commutative comonoids to the underlying symmetric monoidal category $(\mathbb{L}, \otimes, 1)$. Finally, we apply Corollary 18 in Section 6.5 and deduce that the category $\text{Comon}(\mathbb{L}, \otimes, 1)$ is cartesian.

This establishes that

Proposition 23 *Every Lafont category defines a linear-non-linear adjunction, and thus, a model of intuitionistic linear logic.*

Remark. One well-known limitation of this categorical axiomatization is that the exponential modality is necessarily interpreted as a free construction. This limitation is problematic in many concrete case studies, especially in game semantics, where several exponential modalities may coexist in the same category \mathbb{L} , each of them expressing a particular duplication policy: repetitive vs. non repetitive, uniform vs. non uniform, etc. The interested reader will find more about this topic here [53, 70]. It is thus useful to point out that the category

$\text{Comon}(\mathbb{L}, \otimes, 1)$ may be replaced by any *full* subcategory \mathbb{M} closed under tensor product and containing the unit comonoid 1 . In that situation, the original definition of Lafont category is conveniently extended to the following definition of what we called “new-Lafont category” in [72]: a symmetric monoidal closed category $(\mathbb{L}, \otimes, 1)$ satisfying the additional property that the (restriction to \mathbb{M} of the) forgetful functor

$$U : \mathbb{M} \longrightarrow \mathbb{L}$$

has a right adjoint. As previously, this definition may be stated alternatively as a universality property of the morphism

$$\varepsilon_A : !A \longrightarrow A$$

with respect, this time, to the commutative comonoids (X, d, e) appearing in the subcategory \mathbb{M} , instead of all the commutative comonoids. We leave the reader check that Proposition 23 adapts smoothly to this new definition. This extended definition of Lafont category is very useful: we will see for instance in Chapter 8 that it axiomatizes properly the qualitative (or set-theoretic) modality $!_{\text{set}}$ on coherence spaces. We will also take advantage of this extended definition later in this chapter, when we crossbreed the two definitions of Lafont and of Seely category in Section 7.5.

7.3 Seely categories

A *Seely category* is defined as a symmetric monoidal closed category $(\mathbb{L}, \otimes, 1)$ with finite products (binary product noted $A \& B$ and terminal object noted \top) together with

1. a comonad $(!, \delta, \varepsilon)$,
2. two natural isomorphisms

$$m_{A,B}^2 : !A \otimes !B \cong !(A \& B) \qquad m^0 : 1 \cong !\top$$

making

$$(!, m) : (\mathbb{L}, \&, \top) \longrightarrow (\mathbb{L}, \otimes, 1)$$

a symmetric monoidal functor.

Finally, one asks that the coherence diagram

$$\begin{array}{ccc}
 !A \otimes !B & \xrightarrow{m} & !(A \& B) \\
 \downarrow \delta_A \otimes \delta_B & & \downarrow \delta_{A \& B} \\
 !!A \otimes !!B & \xrightarrow{m} & !!(A \& B) \\
 & & \downarrow !\langle \pi_1, \pi_2 \rangle \\
 & & !(A \& !B)
 \end{array} \tag{72}$$

commutes in the category \mathbb{L} for all objects A and B .

Recall from Chapter 5 that our hypothesis that the functor $(!, m)$ is symmetric monoidal means that the four diagrams

$$\begin{array}{ccc}
 (!A \otimes !B) \otimes !C & \xrightarrow{\alpha} & !A \otimes (!B \otimes !C) \\
 m \otimes !C \downarrow & & \downarrow !A \otimes m \\
 !(A \& B) \otimes !C & & !A \otimes !(B \& C) \\
 m \downarrow & & \downarrow m \\
 !((A \& B) \& C) & \xrightarrow{! \alpha} & !(A \& (B \& C))
 \end{array} \tag{73}$$

$$\begin{array}{ccc}
 !A \otimes 1 & \xrightarrow{\rho} & !A & & 1 \otimes !B & \xrightarrow{\lambda} & !B \\
 !A \otimes m \downarrow & & \uparrow !\rho & & m \otimes !B \downarrow & & \uparrow !\lambda \\
 !A \otimes !\top & \xrightarrow{m} & !(A \& \top) & & !\top \otimes !B & \xrightarrow{m} & !(\top \& B)
 \end{array} \tag{74}$$

$$\begin{array}{ccc}
 !A \otimes !B & \xrightarrow{\gamma} & !B \otimes !A \\
 m \downarrow & & \downarrow m \\
 !(A \& B) & \xrightarrow{! \gamma} & !(B \& A)
 \end{array} \tag{75}$$

commute in the category \mathbb{L} for all objects A, B and C .

A general categorical argument explained in the course of Section 6.7 and Section 6.8 establishes that the comonad $(!, \delta, \epsilon)$ generates an adjunction

$$\begin{array}{ccc}
 & L & \\
 \mathbb{L}_! & \curvearrowright & \mathbb{L} \\
 & M & \\
 & \perp &
 \end{array} \tag{76}$$

between the original category \mathbb{L} and the Kleisli category $\mathbb{L}_!$ associated to the comonad. At this point, we want to show that the adjunction (76) defines a linear-non-linear adjunction. To that purpose, we need to establish two properties in turn:

1. that the Kleisli category $\mathbb{L}_!$ is cartesian,
2. that the adjunction (76) lifts to a symmetric lax monoidal adjunction.

The Kleisli category $\mathbb{L}_!$ is cartesian. The proof is not particularly difficult. By definition of Seely category, the category \mathbb{L} is cartesian, with finite products noted $(\&, \top)$. As a right adjoint functor, the functor M preserves limits, and in

particular finite products. This establishes that the image $A\&B = M(A\&B)$ of the cartesian product $A\&B$ of the objects A and B in the category \mathbb{L} defines a cartesian product of the objects $A = M(A)$ and $B = M(B)$ in the category $\mathbb{L}_!$. Similarly, the image $\top = M(\top)$ of the terminal object \top in the category \mathbb{L} is a terminal object in the category $\mathbb{L}_!$. This establishes that the category $\mathbb{L}_!$ is cartesian, with finite products $(\&, \top)$ inherited from the category \mathbb{L} . Note that the argument is quite general: it shows indeed that the Kleisli category \mathbb{C}_K induced by a comonad K in a cartesian category \mathbb{C} inherits the cartesian structure from \mathbb{C} .

Although the proof is completed, it is worth explaining for illustration how the cartesian product $\&$ lifts from a bifunctor on the category \mathbb{L} to a bifunctor on the category $\mathbb{L}_!$. Every pair of morphisms

$$f : A \longrightarrow A' \quad \text{and} \quad g : B \longrightarrow B' \quad (77)$$

in the category $\mathbb{L}_!$ may be seen alternatively as a pair of morphisms

$$f : !A \longrightarrow A' \quad \text{and} \quad g : !B \longrightarrow B'$$

in the category \mathbb{L} . The morphism $f\&g$ in the category $\mathbb{L}_!$ is then defined as the morphism

$$f\&g : !(A\&B) \xrightarrow{\langle !\pi_1, !\pi_2 \rangle} (!A\&!B) \xrightarrow{f\&g} A'\&B' \quad (78)$$

in the category \mathbb{L} . This is related to the discussion at the end of Section 6.10. The lifting property mentioned in Proposition 22 of Section 7.1 implies that the comonad $!$ on the cartesian category \mathbb{L} lifts (in a unique way) to a symmetric oplax monoidal comonad $(!, n)$ on the symmetric monoidal category $(\mathbb{L}, \&, \top)$. The coercion n is provided by the family of morphisms

$$n_{A,B}^2 : !(A\&B) \xrightarrow{\langle !\pi_1, !\pi_2 \rangle} !A\&!B$$

where π_1 and π_2 denote the two projections of the cartesian product, and $\langle -, - \rangle$ denotes the pairing bracket; and by the unique morphism

$$n^0 : !\top \longrightarrow \top$$

to the terminal object. The definition (78) of $f\&g$ is thus an instance of the definition (64) of a tensor product \otimes_K for the Kleisli category \mathbb{C}_K associated to a symmetric oplax monoidal monad K , exposed at the end of Section 6.10.

The adjunction (76) lifts to a symmetric lax monoidal adjunction. We have just established that the Kleisli category $\mathbb{L}_!$ associated to the comonad $!$ is cartesian. We still need to show that the adjunction (76) lifts to a symmetric

monoidal adjunction

$$\begin{array}{ccc}
 & \xrightarrow{(L,m)} & \\
 (\mathbb{L}_!, \&, \top) & \perp & (\mathbb{L}, \otimes, 1) \\
 & \xleftarrow{(M,n)} &
 \end{array}$$

in order to establish that every Seely category induces a linear-non-linear adjunction. Our characterization of symmetric monoidal adjunctions in Proposition 14 (Section 5.17) ensures that this reduces to showing that the functor L equipped with a particular family m of isomorphisms in \mathbb{L} defines a strong monoidal functor. The axioms of a Seely category are precisely intended to provide these isomorphisms m . One main difficulty in order to establish that (L, m) defines a strong monoidal functor, is to show that the family of isomorphisms m is natural with respect to the category $\mathbb{L}_!$ and not only with respect to the category \mathbb{L} . The functor L transports every morphism

$$f : A \longrightarrow B$$

of the category $\mathbb{L}_!$ seen alternatively as a morphism

$$f : !A \longrightarrow B$$

of the category \mathbb{L} , to the morphism

$$L(f) : !A \xrightarrow{\delta_A} !!A \xrightarrow{!f} !B$$

of the category \mathbb{L} . Thus, naturality of m with respect to the category $\mathbb{L}_!$ means that the following diagram

$$\begin{array}{ccc}
 !A \otimes !B & \xrightarrow{m} & !(A \& B) \\
 \delta \otimes \delta \downarrow & & \downarrow \delta \\
 !!A \otimes !!B & & !!(A \& B) \\
 !f \otimes !g \downarrow & & \downarrow !(! \pi_1, ! \pi_2) \\
 !A' \otimes !B' & \xrightarrow{m} & !(A' \& B') \\
 & & \downarrow !(f \& g)
 \end{array} \tag{79}$$

commutes in the category \mathbb{L} for every pair of morphisms f and g depicted in (77). Note that we take advantage here of our explicit description in Equation (78) of the morphism $f \& g$ in the category $\mathbb{L}_!$. Commutativity of Diagram (79) is established by the following diagram chase

$$\begin{array}{ccc}
!A \otimes !B & \xrightarrow{m} & !(A \& B) \\
\downarrow \delta \otimes \delta & & \downarrow \delta \\
!!A \otimes !!B & \xrightarrow{m} & !!(A \& B) \\
\downarrow !f \otimes !g & & \downarrow !(f \& g) \\
!A' \otimes !B' & \xrightarrow{m} & !(A' \& B')
\end{array}
\quad
\begin{array}{l}
(1) \\
(2)
\end{array}
\quad
\begin{array}{l}
(1) \text{ coherence diagram (75),} \\
(2) \text{ naturality of } m \text{ with respect to } \mathbb{L}.
\end{array}$$

which combines the first coherence diagram (75) defining a Seely category, to the naturality of m with respect to the category \mathbb{L} . This establishes the naturality of m with respect to the category $\mathbb{L}_!$.

One concludes the proof by observing that the last four coherence diagrams (73—75) defining a Seely category are precisely here to ensure that (L, m) defines a strong monoidal functor from the cartesian category $(\mathbb{L}_!, \&, \top)$ to the symmetric monoidal category $(\mathbb{L}, \otimes, 1)$. From this follows that

Proposition 24 *Every Seely category defines a linear-non-linear adjunction, and thus a model of intuitionistic linear logic with additives.*

The converse property is easily established at this stage.

Proposition 25 *Suppose that \mathbb{L} is a cartesian and symmetric monoidal closed category, involved in a linear-non-linear adjunction (70). Suppose moreover that the functor*

$$M : \mathbb{L} \longrightarrow \mathbb{M}$$

is bijective on objects. Then, the category \mathbb{L} and the comonad $! = L \circ M$ define a Seely category, whose Kleisli category $\mathbb{L}_!$ is isomorphic to the category \mathbb{M} .

Proof. The proof is based on the observation that the two following statements are equivalent, for any adjunction $L \dashv M$:

- the functor $M : \mathbb{L} \longrightarrow \mathbb{M}$ is bijective on objects,
- the category \mathbb{M} is isomorphic to the Kleisli category $\mathbb{L}_!$ induced by the comonad $! = L \circ M$ associated to the adjunction.

This enables to identify the two categories \mathbb{M} and $\mathbb{L}_!$. Accordingly, the functor $L : \mathbb{M} \longrightarrow \mathbb{L}$ transports every object A in $\mathbb{M} = \mathbb{L}_!$ to the object $!A$ in \mathbb{L} . The coercion of the strong monoidal functor (L, m) provides the two natural isomorphisms

$$m_{A,B}^2 : !A \otimes !B \cong !(A \& B) \qquad m^0 : 1 \cong !\top$$

defining a Seely category. We still need to check the five coherence diagrams (72—75). The first coherence diagram: Diagram (72) follows from naturality of m with respect to the Kleisli category $\mathbb{L}_!$. Indeed, the diagram coincides with Diagram (79) instantiated at the identity

$$f = id_{!A} : !A \longrightarrow !A \quad g = id_{!B} : !B \longrightarrow !B$$

in the category \mathbb{L} seen alternative in the category $\mathbb{M} = \mathbb{L}_!$ as components

$$f = \eta_A : A \longrightarrow !A \quad g = \eta_B : B \longrightarrow !B$$

of the unit η of the monad $! = M \circ L$ induced by the adjunction $L \dashv M$. Commutativity of the four last coherence diagrams (73—75) is an immediate consequence of the fact that the functor (L, m) is symmetric strong monoidal. This establishes Proposition 25. \square

Remark. Here, we call Seely category what Gavin Bierman calls a new-Seely category in his work on categorical models of linear logic [16]. See the discussion at the end of the chapter.

7.4 Linear categories

A *linear category* is a symmetric monoidal closed category $(\mathbb{L}, \otimes, 1)$ together with

1. a symmetric monoidal comonad $((!, m), \delta, \varepsilon)$ in the lax monoidal sense,
2. two monoidal natural transformations d and e whose components

$$d_A : !A \longrightarrow !A \otimes !A \quad e_A : !A \longrightarrow 1$$

form a commutative comonoid (A, d_A, e_A) for all object A .

Moreover, one requires that for every object A

3. the two morphisms d_A and e_A are coalgebra morphisms,
4. the morphism δ_A is a comonoid morphism.

Diagrammatically, these two additional assertions require (for Assertion 3.) that the two diagrams

$$\begin{array}{ccc}
 !A & \xrightarrow{d_A} & !A \otimes !A \\
 \delta_A \downarrow & & \downarrow \delta_A \otimes \delta_A \\
 !!A & \xrightarrow{!d_A} & !(A \otimes A) \\
 & & \downarrow m \\
 & & !!A \otimes !!A
 \end{array}
 \qquad
 \begin{array}{ccc}
 !A & \xrightarrow{e_A} & 1 \\
 \delta_A \downarrow & & \downarrow m \\
 !!A & \xrightarrow{!e_A} & !1
 \end{array}$$

commute, and (for Assertion 4.) that the two diagrams

$$\begin{array}{ccc}
 !A & \xrightarrow{\delta_A} & !!A \\
 \downarrow d_A & & \downarrow d_{!A} \\
 !A \otimes !A & \xrightarrow{\delta_A \otimes \delta_A} & !!A \otimes !!A
 \end{array}
 \qquad
 \begin{array}{ccc}
 !A & \xrightarrow{\delta_A} & !!A \\
 \searrow e_A & & \swarrow e_{!A} \\
 & 1 &
 \end{array}$$

commute for every object A .

We will establish below that every linear category induces a linear-non-linear adjunction. By a general categorical property discussed in Section 6.10, we know already that the (lax) symmetric monoidal comonad $((!, m), \delta, \varepsilon)$ induces a symmetric monoidal adjunction

$$\begin{array}{ccc}
 & \xrightarrow{(L,m)} & \\
 (\mathbb{L}^!, \otimes, 1) & \perp & (\mathbb{L}, \otimes, 1) \\
 & \xleftarrow{(M,n)} &
 \end{array}
 \tag{80}$$

So, we only have to establish that the monoidal structure $(\otimes, 1)$ inherited from the category \mathbb{L} defines a cartesian structure in the category $\mathbb{L}^!$ of Eilenberg-Moore coalgebras. The recipe applied to transport the monoidal structure from the category \mathbb{L} to its category $\mathbb{L}^!$ of Eilenberg-Moore coalgebras is recalled in Equation (63) of Section 6.10.

Plan of the proof. We establish below that the monoidal structure $(\otimes, 1)$ defines a cartesian product on the category $\mathbb{L}^!$ if and only if the three additional assertions 2, 3 and 4 are satisfied. The proof is elementary but far from immediate. In particular, it does not seem to follow from general abstract properties. The argument may be summarized as follows. In a linear category, every free coalgebra $(!A, \delta_A)$ is equipped with a comonoid structure. The idea is to transport this comonoid structure to every coalgebra (A, h_A) by using the fact that every such coalgebra is a retract of the free coalgebra $(!A, \delta_A)$. This is the purpose of Propositions 26 and 27. This recipe provides every coalgebra (A, h_A) with a pair of morphisms

$$A \xrightarrow{\mathbf{d}_A} A \otimes A \qquad A \xrightarrow{\mathbf{e}_A} 1$$

The purpose of Proposition 28 is then to establish that the two morphisms \mathbf{d}_A and \mathbf{e}_A are coalgebra morphisms, and define a monoidal natural transformation in the symmetric monoidal category $(\mathbb{L}^!, \otimes, 1)$ of Eilenberg-Moore coalgebras. Once this fact established, there only remains to apply the characterization of cartesian categories formulated in the previous Chapter 6 (see Corollary 17 in

Section 6.4) in order to conclude that the monoidal structure $(\otimes, 1)$ is cartesian in the category $\mathbb{L}^!$ of Eilenberg-Moore coalgebras. This establishes that every linear category induces a linear-non-linear adjunction (80) with its category $\mathbb{L}^!$ of Eilenberg-Moore coalgebras. The converse property, stated by Proposition 30, is reasonably immediate. We hope that this short summary will help the reader to grasp the general argument of the proof.

We start the proof by a basic observation on linear categories.

Proposition 26 *In a linear category \mathbb{L} , every coalgebra (A, h_A) induces a retraction*

$$A \xrightarrow{h_A} !A \xrightarrow{\varepsilon_A} A$$

making the diagram

$$\begin{array}{ccc}
 A & \xrightarrow{h_A} & !A \\
 h_A \downarrow & & \downarrow d_A \\
 !A & & \\
 d_A \downarrow & & \\
 !A \otimes !A & & \\
 \varepsilon_A \otimes \varepsilon_A \downarrow & & \\
 A \otimes A & \xrightarrow{h_A \otimes h_A} & !A \otimes !A
 \end{array} \tag{81}$$

commute.

Proof. By definition of a linear category, the diagram

$$\begin{array}{ccc}
 !A & \xrightarrow{\delta_A} & !!A \\
 d_A \downarrow & & \downarrow d_{!A} \\
 !A \otimes !A & \xrightarrow{\delta_A \otimes \delta_A} & !!A \otimes !!A
 \end{array}$$

commutes for every object A . Post-composing this diagram with the morphism $\varepsilon_A \otimes \varepsilon_A$ and then applying the equality $\varepsilon_A \circ \delta_A = id_{!A}$ induces another commutative diagram

$$\begin{array}{ccc}
 !A & \xrightarrow{\delta_A} & !!A \\
 d_A \downarrow & & \downarrow d_{!A} \\
 !A \otimes !A & \xleftarrow{\varepsilon_A \otimes \varepsilon_A} & !!A \otimes !!A
 \end{array} \tag{82}$$

We deduce from the diagram chase below that Diagram (81) commutes for every coalgebra h_A in a linear category.

$$\begin{array}{ccccc}
A & \xrightarrow{h_A} & !A & \xrightarrow{id} & !A \\
\downarrow h_A & & \downarrow \delta_A & & \downarrow d_A \\
!A & \xrightarrow{!h_A} & !!A & & \\
\downarrow d_A & & \downarrow d_{!A} & & \downarrow d_A \\
!A \otimes !A & \xrightarrow{!h_A \otimes !h_A} & !!A \otimes !!A & & \\
\downarrow \varepsilon_A \otimes \varepsilon_A & & \downarrow \varepsilon_{!A} \otimes \varepsilon_{!A} & & \downarrow d_A \\
A \otimes A & \xrightarrow{h_A \otimes h_A} & !A \otimes !A & \xrightarrow{id} & !A \otimes !A
\end{array}$$

- (a) property of the coalgebra h_A
- (b) naturality of d
- (c) naturality of ε
- (d) Diagram (82) commutes

This concludes the proof of Proposition 26. \square

Proposition 27 Suppose that in a monoidal category $(\mathbb{C}, \otimes, 1)$ there exists a retraction

$$A \xrightarrow{i} B \xrightarrow{r} A = A \xrightarrow{id_A} A \quad (83)$$

between an object A and a comonoid (B, d_B, e_B) . Then, the two following statements are equivalent:

- the object A lifts as a comonoid (A, d_A, e_A) in such a way that the morphism

$$A \xrightarrow{i} B$$

defines a comonoid morphism

$$(A, d_A, e_A) \xrightarrow{i} (B, d_B, e_B) \quad (84)$$

- the diagram

$$\begin{array}{ccc}
A & \xrightarrow{i} & B \\
\downarrow i & & \downarrow d_B \\
B & & \\
\downarrow d_B & & \\
B \otimes B & & \\
\downarrow r \otimes r & & \\
A \otimes A & \xrightarrow{i \otimes i} & B \otimes B
\end{array} \quad (85)$$

commutes.

Besides, when the two properties hold, the comonoid (A, d_A, e_A) is defined in a unique possible way, as

$$\boxed{\begin{array}{l} A \xrightarrow{d_A} A \otimes A = A \xrightarrow{i} B \xrightarrow{d_B} B \otimes B \xrightarrow{r \otimes r} A \otimes A \\ A \xrightarrow{e_A} 1 = A \xrightarrow{i} B \xrightarrow{e_B} 1 \end{array}} \quad (86)$$

Proof. The direction (\Rightarrow) is easy. Suppose indeed that (A, d_A, e_A) defines a comonoid such that i defines a comonoid morphism (84). In that case, by definition of a comonoid morphism, the two diagrams

$$\begin{array}{ccc} A & \xrightarrow{i} & B \\ d_A \downarrow & & \downarrow d_B \\ A \otimes A & \xrightarrow{i \otimes i} & B \otimes B \end{array} \qquad \begin{array}{ccc} A & \xrightarrow{i} & B \\ e_A \searrow & & \swarrow e_B \\ & 1 & \end{array}$$

commute. Now, the diagram

$$\begin{array}{ccc} A & \xrightarrow{i} & B \\ d_A \downarrow & & \downarrow d_B \\ A \otimes A & \xleftarrow{r \otimes r} & B \otimes B \end{array}$$

commutes as well, because it is obtained by post-composing the left-hand side diagram with the morphism $r \otimes r$, and by applying the equality $r \circ i = id_A$. This establishes already that the comonoid A is necessarily defined by Equation (86). In particular, the equality

$$d_A = (r \otimes r) \circ d_B \circ i$$

implies that Diagram (85) commutes, for the simple reason that i is a comonoid morphism.

We prove the difficult direction (\Leftarrow) now. Suppose that Diagram (85) commutes. We want to show that the triple (A, d_A, e_A) defined in Equation (86) satisfies the equational properties of a comonoid: associativity, units. The two diagrams below are obtained by post-composing part (a) of Diagram (86) with the

morphism $B \otimes r$ and the morphism $r \otimes B$, and by applying the equality $r \circ i = id_A$:

$$\begin{array}{ccc}
 A & \xrightarrow{i} & B \\
 i \downarrow & & \downarrow d_B \\
 B & & B \\
 d_B \downarrow & & \downarrow d_B \\
 B \otimes B & & B \otimes B \\
 r \otimes r \downarrow & & \downarrow B \otimes r \\
 A \otimes A & \xrightarrow{i \otimes A} & B \otimes A
 \end{array}
 \qquad
 \begin{array}{ccc}
 A & \xrightarrow{i} & B \\
 i \downarrow & & \downarrow d_B \\
 B & & B \\
 d_B \downarrow & & \downarrow d_B \\
 B \otimes B & & B \otimes B \\
 r \otimes r \downarrow & & \downarrow r \otimes B \\
 A \otimes A & \xrightarrow{A \otimes i} & A \otimes B
 \end{array}
 \tag{87}$$

By construction, the two diagrams commute. Associativity of comultiplication d_A is established by the diagram chase below.

$$\begin{array}{ccccccc}
 A & \xrightarrow{i} & B & \xrightarrow{d_B} & B \otimes B & \xrightarrow{r \otimes r} & A \otimes A \\
 i \downarrow & \searrow i & & & & & \downarrow A \otimes i \\
 B & & B & \xrightarrow{d_B} & B \otimes B & \xrightarrow{r \otimes B} & A \otimes B \\
 d_B \downarrow & & \downarrow d_B & & \downarrow B \otimes d_B & & \downarrow A \otimes d_B \\
 B \otimes B & \xrightarrow{r \otimes r} & B \otimes B & \xrightarrow{d_B \otimes B} & (B \otimes B) \otimes B & \xrightarrow{\alpha} & B \otimes (B \otimes B) & \xrightarrow{r \otimes (B \otimes B)} & A \otimes (B \otimes B) \\
 \downarrow r \otimes r & & \downarrow B \otimes r & & \downarrow (B \otimes B) \otimes r & & \downarrow (B \otimes B) \otimes r & & \downarrow A \otimes (r \otimes r) \\
 A \otimes A & \xrightarrow{i \otimes A} & B \otimes A & \xrightarrow{d_B \otimes A} & (B \otimes B) \otimes A & \xrightarrow{(r \otimes r) \otimes A} & (A \otimes A) \otimes A & \xrightarrow{\alpha} & A \otimes (A \otimes A)
 \end{array}$$

- (a) left-hand side of Diagram (87),
- (b) right-hand side of Diagram (87),
- (c) coassociativity of d_B ,
- (d) bifunctoriality of \otimes ,
- (e) bifunctoriality of \otimes ,
- (f) naturality of α and bifunctoriality of \otimes .

Similarly, one of the two equalities

$$A \xrightarrow{d_A} A \otimes A \xrightarrow{e_A \otimes A} 1 \otimes A \xrightarrow{\lambda_A} A = A \xrightarrow{i} B \xrightarrow{r} A = A \xrightarrow{id_A} A$$

expected from the unit e_A is established by the diagram chase below.

$$\begin{array}{ccccc}
A & \xrightarrow{i} & B & \xrightarrow{id} & B \\
\downarrow i & & \downarrow d_B & & \downarrow id \\
B & & B & & B \\
\downarrow d_B & & \downarrow d_B & & \downarrow id \\
B \otimes B & & B \otimes B & \xrightarrow{e_B \otimes B} & 1 \otimes B & \xrightarrow{\lambda_B} & B \\
\downarrow r \otimes r & & \downarrow B \otimes r & & \downarrow 1 \otimes r & & \downarrow r \\
A \otimes A & \xrightarrow{i \otimes A} & B \otimes A & \xrightarrow{e_B \otimes A} & 1 \otimes A & \xrightarrow{\lambda_A} & A
\end{array}$$

- (a) left-hand side of Diagram (87)
- (b) unit law of the comonoid (B, d_B, e_B)
- (c) bifunctionality of \otimes
- (d) naturality of λ

The other expected equality of the unit e_A is established similarly, by a diagram chase involving this time the right-hand side of Diagram (87). This shows that the triple (A, d_A, e_A) defined by the two equalities of Equation (86) satisfies indeed the laws of a comonoid. At this point, it is reasonably immediate that the morphism i in the retraction (83) defines a comonoid morphism (84). Indeed, this fact underlies the hypothesis that Diagram (85) commutes, and the definition of the counit e_A . This concludes the proof of Proposition 27. \square

We carry on our investigation of the category $\mathbb{L}^!$ of Eilenberg-Moore coalgebras equipped with the monoidal structure $(\otimes, 1)$ inherited from the linear category \mathbb{L} . We establish the main result of the section:

Proposition 28 *The monoidal structure inherited from a linear category $(\mathbb{L}, \otimes, 1)$ is cartesian in its category $\mathbb{L}^!$ of Eilenberg-Moore coalgebras.*

Proof. The proof is based on the characterization of cartesian categories among symmetric monoidal categories formulated in Corollary 17 of Section 6.4. Together, Propositions 26 and 27 ensure that in a linear category \mathbb{L} , every coalgebra (A, h_A) induces a comonoid $(A, \mathbf{d}_A, \mathbf{e}_A)$ with comultiplication \mathbf{d}_A and counit \mathbf{e}_A defined as

$$\boxed{
\begin{array}{lcl}
A \xrightarrow{\mathbf{d}_A} A \otimes A & = & A \xrightarrow{h_A} !A \xrightarrow{d_A} !A \otimes !A \xrightarrow{\varepsilon_A \otimes \varepsilon_A} A \otimes A \\
A \xrightarrow{\mathbf{e}_A} 1 & = & A \xrightarrow{h_A} !A \xrightarrow{e_A} 1
\end{array}
} \quad (88)$$

In order to apply Corollary 17, we need to establish that the morphisms \mathbf{d}_A and \mathbf{e}_A are coalgebra morphisms, and that they define monoidal natural transformations in the category $\mathbb{L}^!$ of Eilenberg-Moore coalgebras. We proceed in three steps.

The morphisms \mathbf{d}_A and \mathbf{e}_A are coalgebra morphisms. We have established in Propositions 26 and 27 that the two diagrams

$$\begin{array}{ccc}
 A & \xrightarrow{h_A} & !A \\
 \mathbf{d}_A \downarrow & & \downarrow d_A \\
 A \otimes A & \xrightarrow{h_A \otimes h_A} & !A \otimes !A
 \end{array}
 \qquad
 \begin{array}{ccc}
 A & \xrightarrow{h_A} & !A \\
 \mathbf{e}_A \searrow & & \swarrow e_A \\
 & 1 &
 \end{array}
 \tag{89}$$

commute in the category \mathbb{L} . The right-hand side of the diagram implies immediately that $\mathbf{e}_A = e_A \circ h_A$ is a coalgebra morphism, as the composite of two coalgebra morphisms. This is easily checked: the morphism e_A is a coalgebra morphism by definition of a linear category, and the morphism h_A is a coalgebra morphism because the diagram

$$\begin{array}{ccc}
 A & \xrightarrow{h_A} & !A \\
 h_A \downarrow & & \downarrow h_A \\
 !A & \xrightarrow{!h_A} & !!A
 \end{array}$$

commutes by definition of a coalgebra (A, h_A) .

On the other hand, the proof that $\mathbf{d}_A = h_A \circ d_A \circ (\varepsilon_A \otimes \varepsilon_A)$ defines a coalgebra morphism is not so immediate, at least because the morphism $\varepsilon_A \otimes \varepsilon_A$ has no reason to be a coalgebra morphism. The left-hand side of Diagram (89) shows that the morphism \mathbf{d}_A is the result of lifting the coalgebra morphism $d_{h_A} \circ d_A$ along the coalgebra morphism $h_A \otimes h_A$. Our proof is based on the additional observation that the coalgebra morphism $h_A \otimes h_A$ defines a retraction

$$A \otimes A \xrightarrow{h_A \otimes h_A} !A \otimes !A \xrightarrow{\varepsilon_A \otimes \varepsilon_A} A \otimes A$$

in the underlying category \mathbb{L} . At this point, we apply the lifting property stated in Corollary 20 (Section 6.11) and conclude that the morphism \mathbf{d}_A is a coalgebra morphism.

We have just established that Definition (88) induces for every coalgebra (A, h_A) a comonoid $(A, \mathbf{d}_A, \mathbf{e}_A)$ in the category $(\mathbb{L}^!, \otimes, 1)$ of Eilenberg-Moore coalgebras. There remains to show that the families \mathbf{d} and \mathbf{e} are natural and monoidal transformations in this category.

Naturality of \mathbf{d} and \mathbf{e} . This is nearly immediate. Naturality of \mathbf{d} and \mathbf{e} is equivalent to the statement that every coalgebra morphism

$$f : A \longrightarrow B$$

is at the same time a comonoid morphism

$$f : (A, \mathbf{d}_A, \mathbf{e}_A) \longrightarrow (B, \mathbf{d}_B, \mathbf{e}_B).$$

This fact is not difficult to establish diagrammatically, starting from the explicit definition of \mathbf{d}_A and \mathbf{e}_A provided by Equation (88). Naturality of \mathbf{d} and \mathbf{e} means that the two diagrams below commute.

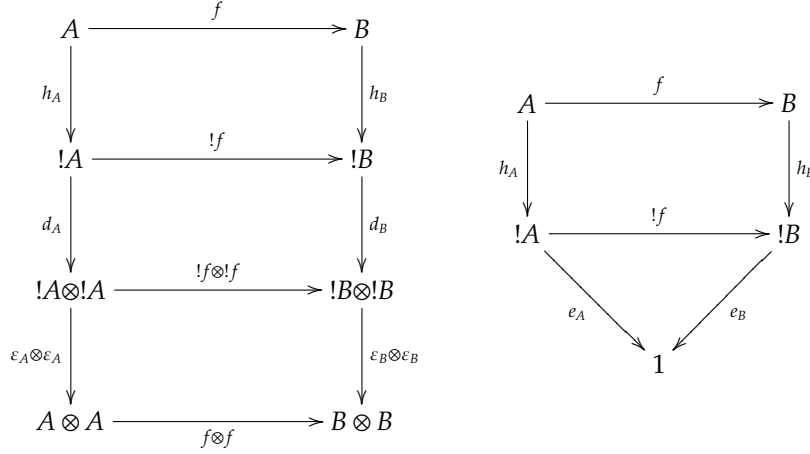

The top squares commute because f is a coalgebra morphism, and the other cells commute by naturality of d and e . This establishes that every coalgebra morphism is a comonoid morphism, or equivalently, that

$$\mathbf{d}_A : A \longrightarrow A \otimes A \qquad \mathbf{e}_A : A \longrightarrow 1$$

are natural transformations in the category \mathbb{L}^1 of Eilenberg-Moore coalgebras.

Monoidality of \mathbf{d} and \mathbf{e} . The remark at the end of Section 6.4 implies that in order to establish that the natural transformations \mathbf{d} and \mathbf{e} are monoidal, one only needs to check the binary part of the definition for \mathbf{d} and the nullary part of the definition for \mathbf{e} . For the binary case, monoidality of \mathbf{d} means that

the diagram

$$\begin{array}{ccccc}
A \otimes B & \xrightarrow{id} & A \otimes B & & \\
\downarrow h_A \otimes h_B & & \downarrow h_A \otimes h_B & & \\
!A \otimes !B & \xrightarrow{m} & !(A \otimes B) & & \\
\downarrow d_A \otimes d_B & & \downarrow d_{A \otimes B} & & \\
(!A \otimes !A) \otimes (!B \otimes !B) & \xrightarrow{!A \otimes \gamma \otimes !B} & (!A \otimes !B) \otimes (!A \otimes !B) & \xrightarrow{m \otimes m} & !(A \otimes B) \otimes !(A \otimes B) \\
\downarrow (\varepsilon_A \otimes \varepsilon_A) \otimes (\varepsilon_B \otimes \varepsilon_B) & (b) & \downarrow (\varepsilon_A \otimes \varepsilon_B) \otimes (\varepsilon_A \otimes \varepsilon_B) & (c) & \downarrow \varepsilon_{A \otimes B} \otimes \varepsilon_{A \otimes B} \\
(A \otimes A) \otimes (B \otimes B) & \xrightarrow{A \otimes \gamma \otimes B} & (A \otimes B) \otimes (A \otimes B) & \xrightarrow{id} & (A \otimes B) \otimes (A \otimes B)
\end{array}$$

(a)

commutes for all coalgebras (A, h_A) and (B, h_B) . This is easily established by diagram chasing. In this diagram, the pentagon (a) commutes because the natural transformation d is monoidal. The square (b) commutes because the symmetry γ is natural. Finally, the triangle (c) commutes because the natural transformation ε is monoidal. This establishes that the diagram commutes.

For the nullary case, monoidality of \mathbf{e} means that the morphism

$$\mathbf{e}_1 : 1 \xrightarrow{h_1} !1 \xrightarrow{e_1} 1$$

is equal to the identity. This is established using the equality $h_1 = m^0$ formulated in Equation (63) of Section 6.10, and the equality

$$1 \xrightarrow{h_1} !1 \xrightarrow{e_1} 1 = 1 \xrightarrow{id} 1$$

which follows from the fact that the natural transformation e is monoidal.

At this point, we are ready to apply Corollary 17 (Section 6.4) and to deduce that the monoidal structure $(\otimes, 1)$ defined in Equation (63) of Section 6.10 is cartesian in the category $\mathbb{L}^!$ of Eilenberg-Moore coalgebras. This concludes the proof of Proposition 28. \square

Remark. One consequence of Proposition 28 is that the natural transformations \mathbf{d} and \mathbf{e} are monoidal (remember indeed that Corollary 17 states an equivalence, not just an implication). However, for the sake of completeness, we establishing here the two cases not treated in the last part of the proof of Proposition 28, this proving (directly) that the natural transformations \mathbf{d} and \mathbf{e} are monoidal. For the nullary case, monoidality of \mathbf{d} means that the morphism

$$\mathbf{d}_1 : 1 \xrightarrow{h_1} !1 \xrightarrow{d_1} !1 \otimes !1 \xrightarrow{\varepsilon \otimes \varepsilon} 1 \otimes 1$$

is inverse to the morphism λ_1 . This is established by the equality $h_1 = m^0$ and the diagram chasing

$$\begin{array}{ccccc}
 1 & \xrightarrow{\lambda_1^{-1}} & 1 \otimes 1 & \xrightarrow{id} & 1 \otimes 1 \\
 \downarrow m^0 & & \downarrow m^0 \otimes m^0 & & \downarrow \varepsilon_1 \otimes \varepsilon_1 \\
 !1 & \xrightarrow{d_1} & !1 \otimes !1 & \xrightarrow{\varepsilon_1 \otimes \varepsilon_1} & 1 \otimes 1
 \end{array}$$

(a) (b)

where the left square (a) commutes by lax monoidality of the functor $(!, m)$ and the right triangle (b) commutes by monoidality of the natural transformation ε . For the binary case, monoidality of \mathbf{e} means that the diagram

$$\begin{array}{ccccc}
 & & !A \otimes !B & \xrightarrow{e_A \otimes e_B} & 1 \otimes 1 \\
 & \nearrow h_A \otimes h_B & \downarrow id & & \downarrow \lambda = \rho \\
 A \otimes B & & & & 1 \\
 & \searrow h_A \otimes h_B & !A \otimes !A & \xrightarrow{m} & !(A \otimes B) \\
 & & & & \nearrow e_{A \otimes B}
 \end{array}$$

(a)

commutes for all coalgebras (A, h_A) and (B, h_B) . This is established by observing that the square (a) commutes because the natural transformation e is monoidal. It is worth remembering in these two proofs that the coercion law $1 \otimes 1 \rightarrow 1$ of the constant functor $(X \mapsto 1)$ is provided by the morphism $\lambda_1 = \rho_1$. Indeed, this morphism defines the multiplication law of the unit of the category $\text{Mon}(\mathbb{L}^!, \otimes, 1)$ of monoids in the category $\mathbb{L}^!$ of Eilenberg-Moore coalgebras, formulated in Equation (56) of Section 6.2.

Since the task of Proposition 28 was precisely to complete the introductory remarks on Diagram (80), we conclude that

Proposition 29 *Every linear category defines a linear-non-linear adjunction, and thus a model of intuitionistic linear logic.*

The converse property is easy to establish at this stage.

Proposition 30 *Suppose that \mathbb{L} is a symmetric monoidal closed category, involved in a linear-non-linear adjunction (70). Suppose moreover that the adjunction*

$$L \dashv M$$

is comonadic. Then, the category \mathbb{L} and the comonad $! = L \circ M$ define a linear category, whose category $\mathbb{L}^!$ of Eilenberg-Moore coalgebras is isomorphic to the category \mathbf{M} .

By comonadic adjunction, we mean an adjunction where \mathbf{M} is isomorphic to the category $\mathbb{L}^!$ of Eilenberg-Moore coalgebras, and the monoidal structure $(\otimes, 1)$ inherited from the symmetric monoidal category $(\mathbb{L}, \otimes, 1)$ provides a cartesian structure in this category. Equivalently, the symmetric monoidal category $(\mathbb{L}^!, \otimes, 1)$ is isomorphic to the cartesian category (\mathbf{M}, \times, e) in the 2-category **SymMonCat** of symmetric monoidal categories and lax monoidal functors introduced in Proposition 10 at the end of Section 5.9.

Proof. The proof of Proposition 30 is reasonably immediate. We have seen at the end of Section 6.9 that every symmetric lax monoidal adjunction (70) induces a symmetric lax monoidal comonad $! = L \circ M$ on the symmetric monoidal category $(\mathbb{L}, \otimes, 1)$. This establishes the first assertion required by the definition of a linear category. By hypothesis, the monoidal structure inherited from the symmetric monoidal category $(\mathbb{L}, \otimes, 1)$ provides the cartesian structure of the category $\mathbb{L}^!$. The second assertion follows then from the characterization of cartesian categories among symmetric monoidal categories formulated in Corollary 17 of Section 6.4. This characterization also implies the third assertion: the two morphisms d_A and e_A are coalgebra morphisms because they are exhibited by Corollary 17 as morphisms in the category $\mathbb{L}^!$ of Eilenberg-Moore coalgebras. Finally, the last assertion required by the definition of a linear category follows from the observation (see Corollary 19 of Section 6.5) that every morphism of a cartesian category is a comonoid morphism. The morphism δ_A is a coalgebra morphism, and thus an element of the cartesian category $(\mathbb{L}^!, \otimes, 1)$. From this follows that the morphism δ_A is a comonoid morphism in the category $(\mathbb{L}^!, \otimes, 1)$ and consequently a comonoid morphism in the underlying category $(\mathbb{C}, \otimes, 1)$. This concludes the proof of Proposition 30. \square

Remark. The proof of Proposition 28 appears originally in Gavin Bierman's PhD thesis [15]. The interested reader will find alternative proofs of Propositions 28 and 30 in Paola Maneggia's PhD thesis [68] as well as in unpublished notes by Andrea Schalk [81] and by Robin Houston [47].

Remark. The last assertion (Assertion 4.) in the definition of a linear category is sometimes replaced in the literature by the apparently stronger requirement that

4bis. whenever $f : (!A, \delta_A) \longrightarrow (!B, \delta_B)$ is a coalgebra morphism between free coalgebras, then it is also a comonoid morphism.

However, the two definitions of linear category are equivalent. On the one hand, Assertion 4. follows from Assertion 4bis. because δ_A is a coalgebra morphism between the free coalgebras $(!A, \delta_A)$ and $(!!A, \delta_{!A})$. Conversely, one deduces Assertion 4bis. from the four assertions defining a linear category at the beginning of the section. We have established in Proposition 28 that the category $\mathbb{L}^!$ is cartesian. By definition, every is a morphism of this category. By Corollary 17 of Section 6.4, every coalgebra morphism $f : (!A, \delta_A) \longrightarrow (!B, \delta_B)$ is thus a comonoid morphism in the category $(\mathbb{L} \otimes, 1)$. Every such morphism f is

thus a comonoid morphism in the underlying category $(\mathbb{L}, \otimes, 1)$. This concludes the short argument establishing that the two alternative definitions of linear category are equivalent.

7.5 Lafont-Seely categories

We introduce here a fourth axiomatization of intuitionistic linear logic, which cross-breeds Lafont categories and Seely categories. The axiomatization is designed to be simple: in particular, it does not require to establish that the modality $!$ defines a comonad — a property which is often difficult to check in full detail, for instance in game-theoretic models. It is also general: unlike the original definition of Lafont categories, the axiomatization is not limited to the free construction.

A *Lafont-Seely category* is defined as a symmetric monoidal closed category $(\mathbb{L}, \otimes, 1)$ with finite products (noted $A \& B$ and \top) together with the following data:

1. for every object A , a commutative comonoid

$$!A = (!A, d_A, e_A)$$

with respect to the tensor product, and a morphism

$$\varepsilon_A : !A \longrightarrow A$$

satisfying the following universal property: for every morphism

$$f : !A \longrightarrow B$$

there exists a unique comonoid morphism

$$f^\dagger : (!A, d_A, e_A) \longrightarrow (!B, d_B, e_B)$$

making the diagram

$$\begin{array}{ccc}
 & & !B \\
 & \nearrow^{f^\dagger} & \downarrow \varepsilon_B \\
 !A & & B \\
 & \searrow_f & \\
 & &
 \end{array} \tag{90}$$

commute,

2. for all objects A and B , two comonoid isomorphisms between the commutative comonoids:

$$p_{A,B}^2 : (!A, d_A, e_A) \otimes (!B, d_B, e_B) \xrightarrow{\cong} (!(A \& B), d_{A \& B}, e_{A \& B})$$

$$p^0 : (1, \rho_1^{-1} = \lambda_1^{-1}, id_1) \xrightarrow{\cong} (!\top, d_\top, e_\top)$$

Every Lafont-Seely category defines a symmetric monoidal adjunction

$$\begin{array}{ccc}
 & \xrightarrow{(L,m)} & \\
 (\mathbb{M}, \otimes, 1) & \perp & (\mathbb{L}, \otimes, 1) \\
 & \xleftarrow{(M,n)} &
 \end{array}$$

in which:

- \mathbb{M} is the full subcategory of $\mathbf{Comon}(\mathbb{L}, \otimes, 1)$ whose objects are the commutative comonoids isomorphic (as comonoids) to a commutative comonoid of the form $(!A, d_A, e_A)$.
- the functor L is the restriction of the forgetful functor U from the cartesian category $\mathbf{Comon}(\mathbb{L}, \otimes, 1)$ of commutative comonoids to the underlying symmetric monoidal category $(\mathbb{L}, \otimes, 1)$.

It follows easily from our Corollary 18 established in Section 6.5 that the category \mathbb{M} equipped with the tensor product \otimes and the tensor unit 1 is cartesian. This establishes that:

Proposition 31 *Every Lafont-Seely category \mathbb{L} induces a linear-non-linear adjunction, and thus a model of intuitionistic linear logic with additives.*

Remark. Coming back to the concluding remark of our Section 7.3 devoted to Lafont categories, we have just defined that every Lafont-Seely category defines in fact a Lafont category in the relaxed sense discussed there.

7.6 Soundness in string diagrams

We briefly mention a diagrammatic proof of soundness for the various categorical semantics discussed in this chapter. A model is *sound* when the interpretation of a proof provides an invariant modulo cut-elimination. So, the purpose of a categorical model of linear logic is precisely to provide a sound model of the logic. Interestingly, the original definition of linear-non-linear adjunction required that the category \mathbb{M} is cartesian closed [13]. People realized only later that this additional condition is not necessary in order to establish soundness: the weaker hypothesis that the category \mathbb{M} is cartesian is sufficient for that purpose [5, 6].

This important observation is supported today by a diagrammatic account based on string diagrams and functorial boxes, two notations recalled in this survey in Section 4.2 (Chapter 4) and in Section 5.7) (Chapter 5). Soundness of this relaxed notion of linear-non-linear adjunction is important because it implies in turn soundness of the alternative axiomatizations of linear logic discussed in this chapter: Lafont categories, Seely categories, Lafont-Seely categories, and linear categories. This fact is an easy consequence of the fact that each axiomatization induces a particular linear-non-linear adjunction.

The diagrammatic argument for soundness is based on the idea that the algebraic decomposition of the exponential modality as

$$! = L \circ M$$

has a purely diagrammatic counterpart, based on the notion of *functorial box* introduced in Section 5.7, and related to the notion of *exponential box* introduced by Jean-Yves Girard for proof-nets of linear logic [40]. Diagrammatically speaking, the decomposition formula means that the exponential box $!$ with its auxiliary doors labeled by the formulas $!A_1, \dots, !A_k$ and with its principal door labeled by the formula $!B$ factors as a functorial box (interpreting the lax monoidal functor M) enshrined inside another functorial box (interpreting the strong monoidal functor L) in the following way:

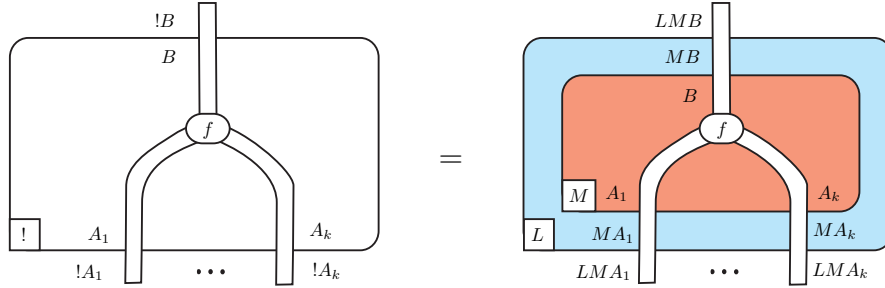

In this diagrammatic formulation, the category \mathbb{M} lies “inside” the functorial box L , while the category \mathbb{L} lies “inside” the functorial box M and “outside” the functorial box L . The category \mathbb{M} is cartesian, with binary product noted \times here. As explained in Section 6.4 (Chapter 6), every object X of the category \mathbb{M} is equipped with a “diagonal” morphism

$$d_X : X \longrightarrow X \times X$$

natural in X . In particular, every object A of the category \mathbb{L} is transported by the functor M to an object MA equipped with a diagonal morphism

$$d_{MA} : MA \longrightarrow MA \times MA$$

in the category \mathbb{M} . The *contraction* combinator of linear logic is interpreted as the morphism $L(d_{MA})$ in the category \mathbb{L} . The morphism is depicted diagrammatically as the diagonal string d_{MA} enshrined inside the functorial box L :

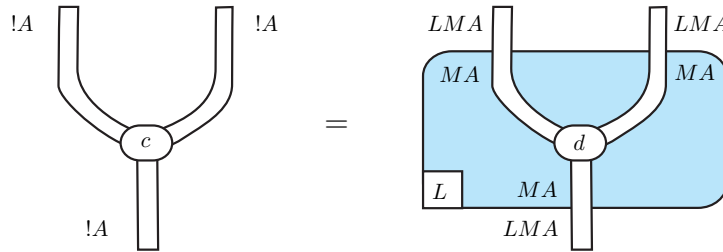

In order to establish soundness of the categorical model, one needs to check in a careful and meticulous way that the interpretation $[\pi]$ of a proof π is invariant modulo all the cut-elimination rules enumerated in Chapter 3. Instead of giving the full argument here, we explain how to proceed with the particularly important and pedagogical example of the cut-elimination step involving a contraction rule and the introduction rule of the exponential modality, explicated in Section 3.9.3 (Chapter 3).

One benefit of translating proofs into string diagrams is that the original cut-elimination step is decomposed into a series of more atomic steps. First, the box L which enshrines the diagonal d_{MA} merges with the box L which enshrines the content f of the exponential box. This releases the diagonal d_{MA} inside the cartesian category \mathbb{M} enshrined in the exponential box.

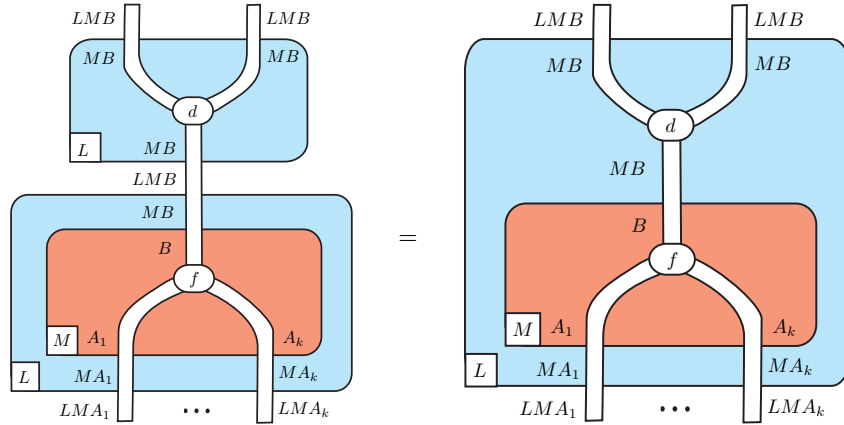

Then, the diagonal d_{MA} replicates the morphism f enshrined by the lax monoidal box M . Note that the duplication step is performed in the cartesian category \mathbb{M} enshrined by the functorial box L , and that the equality follows from the naturality of d .

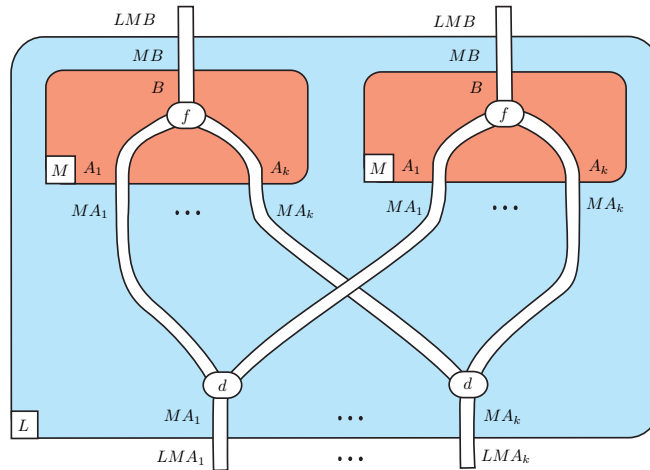

Once the duplication performed, the strong monoidal box is split in three horizontal parts.

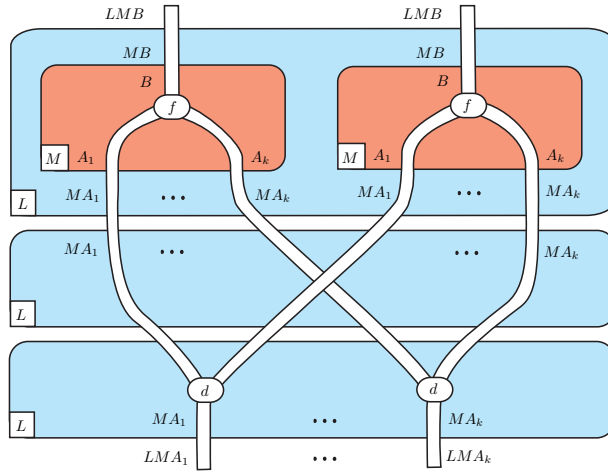

The intermediate box is then removed

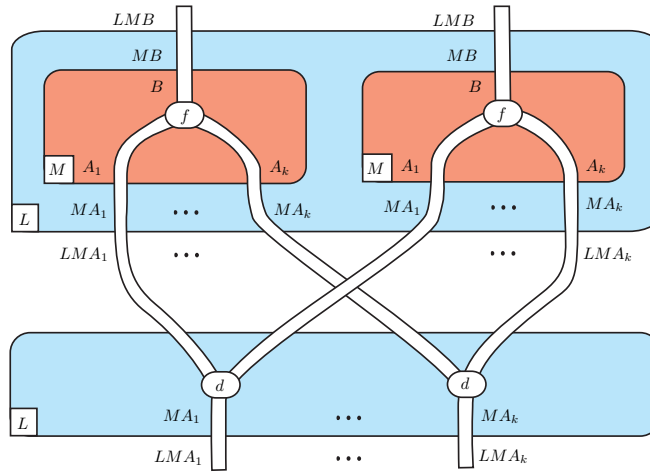

and the remaining monoidal boxes L are split vertically.

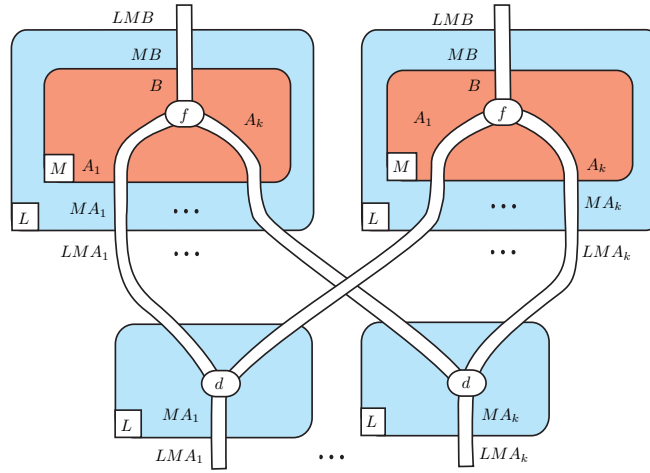

Note that this series of diagrammatic transformations on the functorial box L are valid precisely because the functor L is symmetric and strong monoidal. This completes the categorical and diagrammatic account of this particular cut-elimination step. The other cut-elimination steps of linear logic involving the exponential box $!$ are decomposed in a similar fashion. This diagrammatic account of soundness is a typical illustration of the harmony between proof theory and categorical algebra advocated in this survey.

7.7 Notes and references

In his original formulation, Robert Seely defines a *Girard category* as a $*$ -autonomous category $(\mathbb{L}, \otimes, 1)$ with finite products, together with

1. a comonad $(!, \delta, \varepsilon)$,
2. for every object A , a comonoid $(!A, d_A, e_A)$ with respect to the tensor product,
3. two natural isomorphisms

$$m^2_{A,B} : !A \otimes !B \cong !(A \& B) \qquad m^0 : 1 \cong !\top$$

which transport the comonoid structure (A, Δ_A, u_A) of the cartesian product to the comonoid structure $(!A, d_A, e_A)$ of the tensor product, in the sense that the diagrams

$$\begin{array}{ccc}
 & & !A \otimes !A \\
 & \nearrow d_A & \downarrow m \\
 !A & & \\
 & \searrow !\Delta_A & \downarrow m \\
 & & !(A \& A)
 \end{array}
 \qquad
 \begin{array}{ccc}
 & & 1 \\
 & \nearrow e_A & \downarrow m \\
 !A & & \\
 & \searrow !u_A & \downarrow m \\
 & & !\top
 \end{array}$$

commute.

In Seely’s axiomatization, linear logic is explicitly reduced to a decomposition of intuitionistic logic. To quote Seely in [82]: “what is really wanted [of a model of intuitionistic linear logic] is that the Kleisli category associated to [the comonad] $(!, \delta, \varepsilon)$ be cartesian closed, so the question is: what is the minimal condition on $(!, \delta, \varepsilon)$ that guarantees this — i.e. can we axiomatize this condition satisfactorily?”

A few years later, Nick Benton, Gavin Bierman, Valeria de Paiva and Martin Hyland [12, 50] reconsidered Seely’s axioms from the point of view of linear logic, instead of intuitionistic logic. Surprisingly, they discovered that something is missing in Seely’s axiomatization. More precisely, Bierman points out in [15, 16] that the interpretation of proofs in a Seely category is not necessarily invariant under cut-elimination. One main reason is that the diagram

$$\begin{array}{ccccccc}
 \Gamma & \xrightarrow{f} & !A & \xrightarrow{\delta_A} & !!A & \xrightarrow{!g} & !B \\
 & & \downarrow d_A & & & & \downarrow d_B \\
 & & !A \otimes !A & \xrightarrow{\delta_A \otimes \delta_A} & !!A \otimes !!A & \xrightarrow{!g \otimes !g} & !B \otimes !B \xrightarrow{h} C
 \end{array} \tag{91}$$

which interprets the duplication of a proof

$$!g \circ \delta_A : !A \longrightarrow !B$$

inside a proof

$$h \circ d_B \circ !g \circ \delta_A \circ f : \Gamma \longrightarrow !C$$

does not need to commute in Seely’s axiomatization. Bierman suggests to call *new-Seely* category any Seely category in which the adjunction between the original category \mathbb{L} and its Kleisli category $\mathbb{L}_!$ is symmetric monoidal. This amounts precisely to our definition of Seely category in Section 7.3. In that case, the category provides invariants of proofs, see Proposition 24. In particular, Diagram (91) is shown to commute by pasting the two diagrams below:

$$\begin{array}{ccccccc}
 \Gamma & \xrightarrow{f} & !A & \xrightarrow{\delta_A} & !!A & \xrightarrow{!g} & !B \\
 & & \downarrow d_A & & \downarrow d_A & & \downarrow d_B \\
 & & !A \otimes !A & \xrightarrow{\delta_A \otimes \delta_A} & !!A \otimes !!A & \xrightarrow{!g \otimes !g} & !B \otimes !B \xrightarrow{h} C
 \end{array}$$

The definition of linear-non-linear adjunction was introduced by Nick Benton in [13] after discussions with Martin Hyland and Gordon Plotkin. The interested reader will find related work by Andrew Barber and Gordon Plotkin [5] on Dual Intuitionistic Linear Logic (DILL). The logic DILL is based on a term calculus which was subsequently extended to classical linear logic by Masahito Hasegawa [45]. The three authors develop a comparison to Robin Milner’s action calculi in collaboration with Philippa Gardner [4, 34]. Note that in a somewhat different line of research, Marcelo Fiore, Gordon Plotkin and John Power [79, 32] formulate Axiomatic Domain Theory as a linear-non-linear adjunction with extra structure. See also the fibered variant introduced by Lars Birkedal, Rasmus Møgelberg and Rasmus Lerchedahl Petersen, in order to interpret a linear variant of Abadi & Plotkin logic [17].

8 Two models of interaction: spaces and games

In this last chapter of the survey before the conclusion, we review two models of linear logic, where formulas are interpreted respectively as *coherence spaces* and as *sequential games*. The two models are different in nature:

- the coherence space model is *static* because it reduces a proof to the set of its halting positions. So, in this model, every formula A is interpreted as the graph $[A]$ whose vertices are the halting positions of the formula, and whose edges $x \subset y$ indicate when two halting positions x and y may appear in the same proof. A proof π of formula A is interpreted as a clique $[\pi]$ of the graph $[A]$ consisting of the halting positions of π . The outcome of the interaction between a proof π and a counter-proof π' is provided by the intersection $[\pi] \cap [\pi']$ of their sets $[\pi]$ and $[\pi']$ of halting positions. This intersection $[\pi] \cap [\pi']$ is a clique (as a subset of $[\pi]$) and an anticlique (as a subset of $[\pi']$). Hence, it contains at most one position: the result of the interaction between π and π' .
- the game model is *dynamic* because it interprets a proof as a strategy interacting with its environment. In this model, every formula A is interpreted as a decision tree $[A]$ whose vertices are the intermediate positions of the formula. A proof π of formula A is interpreted as an alternating strategy $[\pi]$ of the game $[A]$ induced by its intermediate (some of them halting) positions. The outcome of the interaction between a proof π and a counter-proof π' is the play obtained by letting the strategy $[\pi]$ interact against the counter-strategy $[\pi']$. The two strategies are deterministic. Hence, this play s is unique, and describes the series of symbolic transformations involved during the interaction between the proofs π and π' .

In this section, we illustrate the idea that the very same model of linear logic (typically, coherence spaces) may be formulated in one style, or in another: linear-non-linear adjunction, Lafont category, Seely category, linear category – this depending on the structure the semanticist wishes to focus on. As explained in Chapter 7, each formulation leads to a linear-non-linear adjunction, and thus, to a model of linear logic.

8.1 Coherence spaces

Jean-Yves Girard discovered in 1986 a very simple account of the stable model of intuitionistic logic defined by Gérard Berry [14] at the end of the 1970s, based on the category **STABLE** of qualitative domains and stable functions [39]. A few months later, Girard realized that (a full subcategory of) the category **STABLE** may be defined alternatively as the Kleisli construction induced by a comonad $!_{\text{set}}$ on a self-dual category **COH** of coherence spaces. This semantic construction is at the origin of linear logic, see [40]. We find useful to start the chapter by recalling it.

Qualitative domains and stable functions

A *qualitative domain* is a pair $X = (|X|, D(X))$ consisting of a set $|X|$ called the *web* of X and a set $D(X)$ of finite subsets of $|X|$, called the *domain* of X . One requires moreover that every subset x of an element $y \in D(X)$ is an element $x \in D(X)$. An element of $D(X)$ is called a *configuration*. Note that, by definition, every configuration is finite.

A *stable function* $f : X \rightarrow Y$ between qualitative domains is a function $D(X) \rightarrow D(Y)$ satisfying

$$\begin{array}{ll} \text{monotonicity} & x \subseteq x' \in D(X) \Rightarrow f(x) \subseteq f(x'), \\ \text{stability} & x, x' \subseteq x'' \in D(X) \Rightarrow f(x \cap x') = f(x) \cap f(x'). \end{array}$$

The category **STABLE** of qualitative domains and stable functions has finite products given by $X \times Y = (|X| + |Y|, D(X) \times D(Y))$ and $1 = (\emptyset, \{\emptyset\})$.

Linear and affine functions

We will be interested in two specific subcategories of **STABLE** in the course of the section. A stable function $f : X \rightarrow Y$ is *linear* when the two following linearity conditions hold:

$$\begin{array}{ll} \text{linearity (binary case)} & x, x' \subseteq x'' \in D(X) \Rightarrow f(x \cup x') = f(x) \cup f(x'). \\ \text{linearity (nullary case)} & f(\emptyset) = \emptyset. \end{array}$$

A stable function $f : X \rightarrow Y$ is *affine* when only the first linearity condition holds:

$$\text{affinity} \quad x, x' \subseteq x'' \in D(X) \Rightarrow f(x \cup x') = f(x) \cup f(x').$$

So, a stable function is $f : X \rightarrow Y$ is linear precisely when for every (possibly empty) finite sequence x_1, \dots, x_n of elements of $D(X)$,

$$x_1, \dots, x_n \subseteq x \in D(X) \Rightarrow f(x_1 \cup \dots \cup x_n) = f(x_1) \cup \dots \cup f(x_n)$$

whereas the equality only holds for nonempty finite sequences x_1, \dots, x_n of elements of $D(X)$ when the function f is affine.

Coherence spaces and cliques

A *coherence space* is a pair $A = (|A|, \circlearrowleft_A)$ consisting of a set $|A|$ called the *web* of A , and a reflexive binary relation \circlearrowleft_A on the elements of $|A|$, called the *coherence* of A . A *clique* of A is a set of pairwise coherent elements of $|A|$. Every coherence space X has a *dual* coherence space A^\perp with same web $|A|$ and coherence relation

$$a \circlearrowleft_{A^\perp} b \iff a = b \text{ or } \neg(a \circlearrowleft_A b)$$

The coherence space $A \multimap B$ has web $|A \multimap B| = |A| \times |B|$ and coherence relation

$$a \multimap b \circlearrowleft_{A \multimap B} a' \multimap b' \iff \begin{cases} a \circlearrowleft_A a' \Rightarrow b \circlearrowleft_B b' \\ \text{and} \\ b \circlearrowleft_{B^\perp} b' \Rightarrow a \circlearrowleft_{A^\perp} a' \end{cases}$$

where $a \multimap b$ is a handy notation for the element (a, b) of the web of the coherence space $A \multimap B$. The category **COH** has coherence spaces as objects, and cliques of $A \multimap B$ as morphisms $A \rightarrow B$. Morphisms are composed as relations, and identities are given by $id_A = \{a \multimap a \mid a \in |A|\}$. The category is symmetric monoidal closed (in fact, $*$ -autonomous) and has finite products. The tensor product $A \otimes B$ of two coherence spaces has web $|A \times B| = |A| \times |B|$ and coherence relation

$$a \otimes b \circlearrowleft_{A \otimes B} a' \otimes b' \iff a \circlearrowleft_A a' \text{ and } b \circlearrowleft_B b'.$$

where, again, $a \otimes b$ is a handy notation for the element (a, b) of the web of the coherence space $A \otimes B$. The monoidal unit e is the coherence space with a unique element (noted $*$) in the web.

Coherent qualitative domains

A qualitative domain $(|X|, D(X))$ is called *coherent* when, for every $x, y, z \in D(X)$:

$$x \cup y \in D(X), y \cup z \in D(X), x \cup z \in D(X) \Rightarrow x \cup y \cup z \in D(X) \quad (92)$$

We will see next section how to construct a functor

$$M : \mathbf{COH} \rightarrow \mathbf{STABLE}$$

which defines an isomorphism

$$M : \mathbf{COH} \xrightarrow{\cong} \mathbf{LINEAR}$$

between the category **COH** and the subcategory **LINEAR** of *coherent* qualitative domains and *linear functions* between them. At the very end of the chapter, we will also consider the category **AFFINE** of coherent qualitative domains and affine functions between them, this enabling us to decompose the exponential modality $!_{\text{set}}$ into a suspension modality S and a duplication modality D , see Section 8.10 for details.

8.2 Coherence spaces: a linear-non-linear adjunction

The two categories **STABLE** and **COH** are involved in a linear-non-linear adjunction $L \dashv M$ which captures the essence of the theory of *traces* developed by Gérard Berry in his PhD thesis [14], see also the account in [2, 87]. We describe the adjunction below.

The left adjoint functor L .

The functor

$$L : \mathbf{STABLE} \rightarrow \mathbf{COH}$$

transports

- every qualitative domain $X = (|X|, D(X))$ to the coherence space

$$L(X) = (D(X), \subset_{D(X)})$$

whose coherence relation $\subset_{D(X)}$ is defined as the usual coherence relation associated to the set-inclusion order on the elements of the domain:

$$\forall x, x' \in D(X), \quad x \subset_{L(X)} x' \iff \exists x'' \in D(X), \quad x, x' \subseteq x''$$

- every stable function $f : X \rightarrow Y$ to the clique $L(f) : L(X) \rightarrow L(Y)$ defined as follows:

$$L(f) = \left\{ (x, y) \mid \begin{array}{l} y \subseteq f(x) \text{ and} \\ \forall x' \in D(X), x' \subseteq x \text{ and } y \subseteq f(x') \Rightarrow x = x' \end{array} \right\}$$

The equalities

$$L(X \otimes Y) = L(X) \times L(Y) \quad L(e) = 1$$

hold for all coherence spaces X and Y . Hence, the functor L defines a *strict* monoidal functor

$$L : (\mathbf{STABLE}, \times, e) \rightarrow (\mathbf{COH}, \otimes, 1).$$

The right adjoint functor M .

The functor

$$M : \mathbf{COH} \rightarrow \mathbf{STABLE}$$

transports

- every coherence space $A = (|A|, \subset_A)$ to the qualitative domain

$$M(A) = (|A|, D(A))$$

whose domain $D(A)$ is the set of finite cliques of A ,

- every clique $f : A \multimap B$ to the linear function $M(f) : M(A) \rightarrow M(B)$ defined as follows:

$$x \in D(A) \mapsto \left\{ b \in |B| \mid \exists a \in x, (a, b) \in f \right\} \in D(B)$$

The linear-non-linear adjunction $L \dashv M$.

We show that the functor L is left adjoint to the functor M . Suppose X is a qualitative domain, that A is a coherence space, and that the function between qualitative domains

$$f : X \rightarrow M(A)$$

is stable. Define

$$\mathbf{trace}(f) \subseteq D(X) \times |A|$$

as the set of elements (x, a) where x is a configuration of X and a is an element of the web of A such that, for all configurations $y, z \in D(X)$ satisfying

$$x \subseteq z \quad \text{and} \quad y \subseteq z$$

the following property holds:

$$x \subseteq y \quad \Longleftrightarrow \quad a \in f(y).$$

Note in particular that

$$\forall (x, a) \in \mathbf{trace}(f), \quad a \in f(x).$$

The point of the construction is that it defines a clique

$$\mathbf{trace}(f) \quad : \quad L(X) \multimap A.$$

In order to establish this, one needs to check that for every two elements (x, a) and (y, b) in $\mathbf{trace}(f)$ are coherent:

$$x \multimap a \quad \circlearrowleft_{L(X) \multimap A} \quad y \multimap b. \quad (93)$$

This amounts to checking that

$$x \circlearrowleft_{L(X)} y \quad \Rightarrow \quad a \circlearrowleft_A b \quad (94)$$

and

$$a \succsim_A b \quad \Rightarrow \quad x \succsim_{L(X)} y. \quad (95)$$

The first statement (94) follows from the definition of $x \circlearrowleft_{L(X)} y$ as the fact that there exists a configuration $z \in D(X)$ such that $x \subseteq z$ and $y \subseteq z$. In that case, $f(x) \subseteq f(z)$ and $f(y) \subseteq f(z)$ because the function f is monotone. Moreover, $a \in f(x)$ and $b \in f(y)$ because (x, a) and (y, b) are elements of $\mathbf{trace}(f)$. One concludes that a and b are elements of the configuration $f(z)$ of the qualitative domain $M(A)$. Since configurations of $M(A)$ are defined as finite cliques in the coherence space A , the two elements a and b are coherent in A . Once the first statement established, the second statement (95) is equivalent to the statement that

$$a = b \quad \Rightarrow \quad x \succsim_{L(X)} y. \quad (96)$$

This follows easily from the definition of $\mathbf{trace}(f)$. Imagine indeed that $a = b$ and that x and y are coherent in $L(X)$, or equivalently, that there exists a configuration z such that $x \subseteq z$ and $y \subseteq z$. The fact that $(x, a) \in \mathbf{trace}(f)$ means that

$$a \in f(y) \quad \Rightarrow \quad x \subseteq y$$

and the fact that $(y, a) \in \mathbf{trace}(f)$ means that

$$a \in f(x) \quad \Rightarrow \quad y \subseteq x.$$

The equality $x = y$ follows immediately from this and the fact that $a \in f(x)$ and $a \in f(y)$. This establishes statement (96) and thus statement (93). We conclude that **trace**(f) defines indeed a clique in the coherence space $L(X) \multimap A$.

Conversely, every clique g in the coherence space $L(X) \multimap A$ generates a stable function

$$\mathbf{fun}(g) : X \longrightarrow M(A)$$

defined as

$$x \mapsto \bigvee \{ a \mid \exists y \subseteq x, (y, a) \in g \}$$

The function is clearly monotone, and its stability reduces to the fact that

$$\mathbf{fun}(g)(x) \cap \mathbf{fun}(g)(x') \subseteq \mathbf{fun}(g)(x \cap x').$$

By definition, every element

$$a \in \mathbf{fun}(g)(x) \cap \mathbf{fun}(g)(x')$$

is induced by a pair $(y, a) \in g$ and $(y', a) \in g$ where $y \subseteq x$ and $y' \subseteq x'$. As subsets of the two compatible configurations x and x' in the qualitative domain X , the two configurations y and y' are also compatible in X – and thus coherent in the coherence space $L(X)$. The very definition of coherence in $L(X) \multimap A$ ensures then that $y = y'$. In particular, the configuration $y = y'$ is a subset of the configuration $x \cap x'$. We conclude that

$$a \in \mathbf{fun}(g)(x \cap x')$$

and hence, that the function **fun**(g) is stable.

Finally, one checks that the two constructions **trace** and **fun** define one-to-one relation

$$\mathbf{trace} : \mathbf{STABLE}(X, M(A)) \cong \mathbf{COH}(L(X), A) : \mathbf{fun}$$

natural in X and A .

Exercise. We leave the reader show that **trace** and **fun** define indeed a bijection natural in A and X . ■

8.3 Coherence spaces: a Seely category

The formulation of the coherence space model as a linear-non-linear adjunction requires an explicit description of the monoidal category **COH** as well as an explicit description of the cartesian category **STABLE**. This is often too much to ask when one encounters a new model of linear logic. In many cases, indeed, a symmetric monoidal closed category \mathbb{L} is given, together with a particular notion of exponential modality. In such a situation, one would like to check that the modality defines indeed a model of linear logic, before providing any description of the associated cartesian category **M**. For that reason, the alternative

axiomatic formulations of linear logic encountered in Chapter 7 are precious, because they offer useful shortcuts in the difficult exercise of designing a new denotational model of linear logic. Indeed, once the basic axiomatic properties of the resource modality are established, the category \mathbf{M} is immediately defined as a category of commutative comonoids (in the case of Lafont categories), as the Kleisli category associated to the modality (in the case of Seely categories), or as the category of Eilenberg-Moore coalgebras of the modality (in the case of linear categories).

This general principle is nicely illustrated by the coherence space model. In that case, the comonad $!_{\text{set}}$ over \mathbf{COH} induced by the adjunction $L \dashv M$ transports every coherence space A to the commutative comonoid $!_{\text{set}}A$ below:

- the web of $!_{\text{set}}A$ is the set of finite *cliques* of A ,
- two cliques u, v are coherent in $!_{\text{set}}A$ when their union $u \cup v$ is a clique in A , or equivalently:

$$u \circlearrowleft_A v \quad \iff \quad \forall a \in u, \forall b \in v, \quad a \circlearrowleft_A b.$$

- coproduct d_A is union of clique, and counit e_A is the empty set:

$$d_A = \{w \multimap (u \otimes v) \mid w = u \cup v, u, v, w \in !_{\text{set}}A\} \quad e_A = \{\emptyset \multimap *\}$$

Instead of building a linear-non-linear adjunction (as we did in Section 8.1) one may show that the comonad $!_{\text{set}}$ satisfies the properties of a Seely category formulated in Section 7.3. One benefit of the approach is that it is not necessary to define the category \mathbf{STABLE} in order to establish that the category \mathbf{COH} and its exponential modality $!_{\text{set}}$ define a model of linear logic. In the case of a Seely category, the category \mathbf{STABLE} is replaced by the Kleisli category $\mathbf{COH}_{!_{\text{set}}}$ associated to the exponential comonad. A simple analysis shows that the Kleisli category coincides in fact with the full subcategory of \mathbf{STABLE} consisting of the *coherent* qualitative domains. See (92) above for the definition of coherent qualitative domain.

8.4 Quantitative coherence spaces: a Lafont category

The original notion of Lafont category is somewhat too restrictive: it requires indeed that the exponential modality coincides with the free commutative comonoid construction. This is not the case with the “qualitative” modality $!_{\text{set}}$ of coherence spaces discussed here. Indeed, the *free* commutative comonoid $!_{\text{mset}}A$ generated by a coherence space A has been characterized by Van de Wiele as the coherence space $!_{\text{mset}}A$ below:

- its web is the set of finite *multicliques* of A ,
- two multicliques are coherent when their sum is a multiclique,

- coproduct is sum of multiclique, and counit is the empty multiset:

$$d_A = \{w \multimap (u \otimes v) \mid w = u \uplus v, u, v, w \in \mathbb{!}_{\text{mset}}A\} \quad e_A = \{\emptyset \multimap *\}$$

Recall that a *multiclique* is a multiset whose support is a clique. The “quantitative” modality $\mathbb{!}_{\text{mset}}$ defines a Lafont category, and thus a model of linear logic. Interestingly, the meaning of the induced Kleisli category $\mathbf{COH}_{\mathbb{!}_{\text{mset}}}$ was explicated only a decade after the quantitative modality was exhibited by van de Wiele: Nuno Barreiro and Thomas Ehrhard [9] show that the Kleisli category coincides with a category \mathbf{CONV} of convex and multiplicative functions.

8.5 Qualitative coherence spaces: a Lafont category

There remains to clarify the status of the qualitative modality $\mathbb{!}_{\text{set}}$ with respect to the class of commutative comonoids in \mathbf{COH} . An important fact in that respect is that the category \mathbf{STABLE} is cartesian. From this follows indeed that the strong and symmetric monoidal functor L factors as

$$\mathbf{STABLE} \xrightarrow{K} \mathbf{Comon}(\mathbf{COH}, \otimes, 1) \xrightarrow{V} \mathbf{COH}$$

where

- V is the forgetful functor from the category $\mathbf{Comon}(\mathbf{COH}, \otimes, 1)$ of commutative comonoids to the category $(\mathbf{COH}, \otimes, 1)$
- K is a full and faithful embedding of \mathbf{STABLE} into $\mathbf{Comon}(\mathbf{C}, \otimes, e)$, defining a strict and symmetric monoidal functor from $(\mathbf{STABLE}, \times, 1)$ to $(\mathbf{Comon}(\mathbf{C}, \otimes, e), \otimes, e)$.

For every qualitative domain X , the coherence space $L(X)$ defines a commutative comonoid

$$K(X) = (D(X), d_X, e_X)$$

equipped with the comultiplication d_X and counit e_X defined as:

$$d_X = \{x \multimap (y \otimes z) \mid x = y \cup z, x, y, z \in D(X)\} \quad e_X = \{\emptyset \multimap *\}$$

Moreover, every stable function $f : X \rightarrow Y$ induces a *comonoidal* morphism $L(f) : L(X) \rightarrow L(Y)$ from $K(X)$ to $K(Y)$; and conversely, every comonoidal morphism $K(X) \rightarrow K(Y)$ is the image of a unique stable function $f : X \rightarrow Y$.

Now, observe that every comonoid appearing in the image of the functor K is a *diagonal* comonoid. A comonoid X over \mathbf{COH} is called *diagonal* when the clique $d_X : X \rightarrow X \otimes X$ contains the diagonal $\{x \multimap (x \otimes x) \mid x \in |X|\}$. In fact, Jacques Van de Wiele established that $\mathbb{!}_{\text{set}}A$ is the free commutative *diagonal* comonoid generated by A . Since diagonal comonoids are closed by tensor product, the construction $\mathbb{!}_{\text{set}}$ defines a Lafont category – in the extended sense of “new-Lafont category” discussed at the end of Section 7.2. This demonstrates in

yet another way that the modality $!_{\text{set}}$ defines a model of linear logic. The cartesian category \mathbb{M} of the linear-non-linear adjunction is provided in this case by the full subcategory of diagonal commutative comonoids in $\mathbf{Comon}(\mathbf{COH}, \otimes, 1)$.

Remark. This factorization phenomenon is not specific to the coherence space model. The factorization holds indeed in any linear-non-linear adjunction, for the conceptual reason that every symmetric strong monoidal functor

$$(L, n) \quad : \quad (\mathbb{M}, \times, 1) \longrightarrow (\mathbb{L}, \otimes, e)$$

lifts to a symmetric strong monoidal functor

$$\mathbf{Comon}(L, n) \quad : \quad \mathbf{Comon}(\mathbb{M}, \times, 1) \longrightarrow \mathbf{Comon}(\mathbb{L}, \otimes, e)$$

making the diagram

$$\begin{array}{ccc} \mathbf{Comon}(\mathbb{M}, \times, 1) & \xrightarrow{\mathbf{Comon}(L, n)} & \mathbf{Comon}(\mathbb{L}, \otimes, e) \\ \downarrow U & & \downarrow V \\ \mathbb{M} & \xrightarrow{L} & \mathbb{L} \end{array}$$

commute. We have seen in Corollary 18 (Section 6) that the forgetful functor U is an isomorphism because the category $(\mathbb{M}, \times, 1)$ is cartesian. The functor

$$K \quad : \quad \mathbb{M} \longrightarrow \mathbf{Comon}(L, \otimes, e)$$

is then defined as $K = \mathbf{Comon}(L, n) \circ U^{-1}$. When the functor K is full and faithful (as it is the case for coherence space) then the functor $K \circ M$ is left adjoint to the functor V restricted to the full subcategory of $\mathbf{Comon}(\mathbb{L}, \otimes, e)$ of objects isomorphic to an image of the functor K . This subcategory is closed under tensor product, because the functor is strong monoidal. So, we have just shown that every linear-non-linear adjunction whose induced functor $\mathbf{Comon}(L, n)$ is full and faithful, defines a Lafont category in the extended sense discussed at the end of Section 7.2.

8.6 Coherence spaces: a Lafont-Seely category

The coherence space model illustrates perfectly well the conceptual advantages of using the definition of Lafont-Seely category introduced in Section 7.5. Suppose that A, B are coherence spaces. The first properties of the model are easily established:

- the coherence space $!_{\text{set}}A$ defines a commutative comonoid in \mathbf{COH} , because set-theoretic union is associative and commutative, and has the empty set as unit,

- the comonoidal isomorphisms

$$!_{\text{set}}A \& B \longrightarrow !_{\text{set}}A \otimes !_{\text{set}}B \quad \text{and} \quad !_{\text{set}}\top \longrightarrow 1$$

are given by the cliques

$$\{ x \multimap (x_A \otimes x_B) \mid x_A = x \cap |A|, x_B = x \cap |B| \} \quad \text{and} \quad \{ \emptyset \multimap * \}.$$

At this point, there only remains to show that the dereliction morphism

$$\varepsilon_A^{\text{set}} = \{ \{a\} \multimap a \mid a \in |A| \}$$

satisfies the universal property (90) of the definition. This amounts to characterizing the comonoidal morphisms

$$g : !_{\text{set}}A \longrightarrow !_{\text{set}}B$$

between two coherence spaces $!_{\text{set}}A$ and $!_{\text{set}}B$. It appears that such a morphism g is comonoidal if and only if it verifies the four properties below:

- unit (forth): if $\emptyset \multimap v$ is an element of the clique g , then $v = \emptyset$,
- unit (back): if $u \multimap \emptyset$ is an element of the clique g , then $u = \emptyset$,
- product (forth): if $u_1 \multimap v_1$ and $u_2 \multimap v_2$ are elements of the clique g and $u = u_1 \cup u_2$ is a clique, then $u \multimap (v_1 \cup v_2)$ is an element of g ,
- product (back): if $u \multimap (v_1 \cup v_2)$ is an element of the clique g , then there exists a pair of cliques u_1, u_2 such that $u = u_1 \cup u_2$ and $u_1 \multimap v_1$ and $u_2 \multimap v_2$ are elements of g .

Now, suppose that g is comonoidal, that u is a clique of A and that $v = \{b_1, \dots, b_n\}$ is a clique of B . From the previous characterization, it follows that

$$\left(\begin{array}{l} u \multimap \{b_1, \dots, b_n\} \\ \text{is an element of } g \end{array} \right) \text{ if and only if } \left(\begin{array}{l} u \text{ decomposes as } u = u_1 \cup \dots \cup u_n \\ \text{where } u_i \multimap \{b_i\} \text{ is in } g. \end{array} \right)$$

This shows that every comonoidal morphism

$$g : !_{\text{set}}A \longrightarrow !_{\text{set}}B$$

is characterized by the composite

$$\varepsilon_B^{\text{set}} \circ g : !_{\text{set}}A \longrightarrow B.$$

Conversely, every morphism

$$f : !_{\text{set}}A \longrightarrow B$$

induces a comonoidal morphism g such that

$$f = \varepsilon_B^{\text{set}} \circ g.$$

The correspondence between f and g is one-to-one. We conclude that the modality $!_{\text{set}}$ defines a Lafont-Seely category, and thus a model of linear logic. This point is further discussed in the next section.

8.7 The relational non-model

The category **COH** may be replaced by the $*$ -autonomous category **RIEL** of sets and relations, equipped with the set-theoretic product $A \times B$ as tensor product $A \otimes B$. The category **RIEL** has finite products, given by set-theoretic sum $A + B$. The category **RIEL** admits also a free commutative comonoid construction, similar to the construction $!_{\text{mset}}$ for coherence spaces discussed in Section 8.4. From this follows that the modality $!_{\text{mset}}$ defines a Lafont category on the category **RIEL** and, thus, a model of linear logic.

It is therefore tempting to adapt the “set-theoretic” interpretation of exponentials discussed in Section 8.3. Indeed, every object A of **RIEL** defines the commutative comonoid $(!_{\text{set}}A, d_A, e_A)$ below:

$$!_{\text{set}}A = \{u \mid u \subseteq_{\text{fin}} A\} \quad d_A = \{(u \cup v) \multimap (u \otimes v) \mid u, v \subseteq_{\text{fin}} A\} \quad e_A = \{(\emptyset, *)\}$$

where $u \subseteq_{\text{fin}} A$ means that u is a finite subset of A ; as well as a “dereliction” morphism

$$\varepsilon_A = \{ \{a\} \multimap a \mid a \in |A| \} \quad : \quad !_{\text{set}}A \longrightarrow A$$

defined as

$$\varepsilon_A = \{ (\{a\}, a) \mid a \in |A| \}.$$

However, this “set-theoretic” interpretation of exponentials fails to define a Seely category. Indeed, Ehrhard pointed out that the dereliction family $(\varepsilon_A)_{A \in \text{RIEL}}$ is not natural. Typically, the naturality diagram below does not commute from $A = \{a_1, a_2\}$ to $B = \{b\}$, for the relation $f = \{(a_1, b), (a_2, b)\}$.

$$\begin{array}{ccc} !A & \xrightarrow{!f} & !B \\ \varepsilon_A \downarrow & & \downarrow \varepsilon_B \\ A & \xrightarrow{f} & B \end{array} \quad (97)$$

$$\begin{array}{l} \{a_1, a_2\} \multimap b \quad \text{is an element of} \quad \varepsilon_B \circ !f \\ \{a_1, a_2\} \multimap b \quad \text{is not an element of} \quad f \circ \varepsilon_B \end{array}$$

This lack of commutation was somewhat unexpected the first time it was noticed. It convinced people that every coherence diagram should be checked extremely carefully every time a new model is introduced. This also propelled the search for alternative categorical axiomatics of linear logic, more conceptual and easier to check than the existing ones. This point is particularly important in game semantics, because its current formalism requires heavy symbolic manipulations on strategies in order to establish even basic categorical facts. This is precisely this work in game semantics which convinced the author [72] to focus on the notion of comonoidal morphism, this leading to the notion of Lafont-Seely category introduced in Section 7.5.

As a matter of illustration, let us show how the notion of Lafont-Seely category clarifies the reasons why the category $\mathbb{R}IEL$ equipped with the modality $!_{\text{set}}$ does *not* define a model of linear logic. Every object A of the category $\mathbb{R}IEL$ is equipped with a “multiplication” defined as

$$\mathbf{mult}_A := \{ (a \otimes a) \multimap a \mid a \in |A| \} : A \otimes A \longrightarrow A.$$

Observe that the diagram

$$\begin{array}{ccc} !_{\text{set}}B & \xrightarrow{\varepsilon_B} & B \\ d_B \downarrow & & \uparrow \mathbf{mult}_B \\ !_{\text{set}}B \otimes !_{\text{set}}B & \xrightarrow{\varepsilon_B \otimes \varepsilon_B} & B \otimes B \end{array}$$

commutes in $\mathbb{R}IEL$, for every set B . Moreover, in a Lafont-Seely category, every morphism

$$f : !_{\text{set}}A \longrightarrow B$$

is supposed to lift as a comonoidal morphism

$$f^\dagger : !_{\text{set}}A \longrightarrow !_{\text{set}}B$$

satisfying the equality $f = \varepsilon_B \circ f^\dagger$. Consequently, every such morphism f should make the diagram below commute:

$$\begin{array}{ccc} !_{\text{set}}A & \xrightarrow{f} & B \\ d_A \downarrow & & \uparrow \mathbf{mult}_B \\ !_{\text{set}}A \otimes !_{\text{set}}A & \xrightarrow{f \otimes f} & B \otimes B \end{array}$$

The commutative diagram translates as the closure property (\star) below:

if $u \multimap b$ and $v \multimap b$ are elements of f then $(u \cup v) \multimap b$ is an element of f .

which should be satisfied by any morphism $f : !_{\text{set}}A \longrightarrow B$ of the category $\mathbb{R}IEL$. This is obviously not the case: hence, the set-theoretic interpretation of the exponential modality does not define a Lafont-Seely category on $\mathbb{R}IEL$.

Remark. The closure property (\star) is common to several variants of the relational model equipped with a “set-theoretic” exponential modality. It is instructive to see how the coherence space model satisfies the property: if $u \multimap b$ and $v \multimap b$ are elements of a clique f , then either $u = v$ or the two elements u and v are incompatible in the coherence space $!_{\text{set}}A$ – and thus, the finite subset $u \cup v$ does not appear as an element of the web of $!_{\text{set}}A$.

Hence coherence is a solution to ensure property (\star) . Another solution appears in a relational model of linear logic introduced by Glynn Winskel [89] where objects are partial orders, and morphisms are downward-closed subsets – see also the related work [28]. One interesting feature of the model is that its Kleisli category is equivalent to Scott’s model of prime algebraic lattices. The model works despite the fact that the exponential modality is interpreted in a set-theoretic fashion. The reason is that property (\star) holds because the element $(u \cup v) \multimap b$ is always smaller than the elements $u \multimap b$ and $v \multimap b$ in the ordered space $(!_{\text{set}}A) \multimap B$.

8.8 Conway games: a compact-closed category

After attending a lecture by John H. Conway at the end of the 1970s, André Joyal realized that he could construct a category \mathbf{G} with Conway games as objects, and winning strategies as morphisms, composed by sequential interaction [54]. This seminal construction provided the first instance of a series of categories of games and strategies, in a trend which became prominent fifteen years later, at the interface between proof theory (linear logic) and denotational semantics (game semantics). This leads to an alternative and purely algebraic account of the abstract machines described by Pierre-Louis Curien and Hugo Herbelin in this volume [29].

Conway games

A Conway game is defined as an oriented graph (V, E, λ) consisting of a set V of vertices, a set $E \subseteq V \times V$ of edges, and a function $\lambda : E \rightarrow \{-1, +1\}$ associating a polarity -1 or $+1$ to every edge of the graph. The vertices are called the *positions* of the game, and the edges its *moves*. Intuitively, a move $m \in E$ is played by Player when $\lambda(m) = +1$ and by Opponent when $\lambda(m) = -1$. As it is usual in graph-theory, we write $x \rightarrow y$ when $(x, y) \in E$, and call *path* any sequence of positions $s = (x_0, x_1, \dots, x_k)$ in which $x_i \rightarrow x_{i+1}$ for every $i \in \{0, \dots, k-1\}$. In that case, we write $s : x_0 \twoheadrightarrow x_k$ to indicate that s is a path from the position x_0 to the position x_k .

In order to be a Conway game, the graph (V, E, λ) is required to verify two additional properties:

- the graph is rooted: there exists a position $*$ called the *root* of the game, such that for every other position $x \in V$, there exists a path from the root $*$ to the position x :

$$* \rightarrow x_1 \rightarrow x_2 \rightarrow x_3 \cdots \rightarrow x_k \rightarrow x,$$

- the graph is well-founded: every sequence of positions

$$* \rightarrow x_1 \rightarrow x_2 \rightarrow x_3 \rightarrow \cdots$$

starting from the root is finite.

A path $s = (x_0, x_1, \dots, x_k, x_{k+1})$ is called *alternating* when:

$$\forall i \in \{1, \dots, k-1\}, \quad \lambda(x_i \rightarrow x_{i+1}) = -\lambda(x_{i-1} \rightarrow x_i).$$

A *play* is defined as a path $s : * \longrightarrow x$ starting from the root. The set of plays of a Conway game A is denoted P_A .

Strategies

A *strategy* σ of the Conway game (E, V, λ) is defined as a set of alternating plays such that, for every positions x, y, z, z_1, z_2 :

1. the empty play $(*)$ is element of σ ,
2. every play $s \in \sigma$ starts by an Opponent move, and ends by a Player move,
3. for every play $s : * \longrightarrow x$, for every Opponent move $x \rightarrow y$ and Player move $y \rightarrow z$,

$$* \xrightarrow{s} x \rightarrow y \rightarrow z \in \sigma \quad \Rightarrow \quad * \xrightarrow{s} x \in \sigma,$$

4. for every play $s : * \longrightarrow x$, for every Opponent move $x \rightarrow y$ and Player moves $y \rightarrow z_1$ and $y \rightarrow z_2$,

$$* \xrightarrow{s} x \rightarrow y \rightarrow z_1 \in \sigma \text{ and } * \xrightarrow{s} x \rightarrow y \rightarrow z_2 \in \sigma \quad \Rightarrow \quad z_1 = z_2.$$

Thus, a strategy is a set of plays closed under even-length prefix (Clause 3) and deterministic (Clause 4). A strategy σ is called *winning* when for every play $s : * \longrightarrow x$ element of σ and every Opponent move $x \rightarrow y$, there exists a position z and a Player move $y \rightarrow z$ such that the play

$$* \xrightarrow{s} x \rightarrow y \rightarrow z$$

is element of the strategy σ . Note that the position z is unique in that case, by determinism. We write $\sigma : A$ to mean that σ is a winning strategy of A .

Duality and tensor product

The dual A^\perp of a Conway game $A = (V, E, \lambda)$ is the Conway game $A^\perp = (V, E, -\lambda)$ obtained by reversing the polarities of moves. The tensor product $A \otimes B$ of two Conway games A and B is the Conway game defined below:

- its positions are the pairs (x, y) noted $x \otimes y$ of a position x of the game A and a position y of the game B ,
- its moves from a position $x \otimes y$ are of two kinds:

$$x \otimes y \rightarrow \begin{cases} u \otimes y & \text{if } x \rightarrow u, \\ x \otimes v & \text{if } y \rightarrow v, \end{cases}$$

- the move $x \otimes y \rightarrow u \otimes y$ is noted $(x \rightarrow u) \otimes y$ and has the polarity of the move $x \rightarrow u$ in the game A ; the move $x \otimes y \rightarrow x \otimes v$ is noted $x \otimes (y \rightarrow v)$ and has the polarity of the move $y \rightarrow v$ in the game B .

Every play s of the tensor product $A \otimes B$ of two Conway games A and B may be projected to a play $s|_A \in P_A$ and to a play $s|_B \in P_B$. The Conway game $1 = (\emptyset, \emptyset, \lambda)$ has an empty set of positions and moves.

The category \mathbf{G} of Conway games and winning strategies

The category \mathbf{G} has Conway games as objects, and winning strategies of $A^\perp \otimes B$ as morphisms $A \rightarrow B$. The identity strategy $id_A : A^\perp \otimes A$ copycats every move received in one component A to the other component. The composite of two strategies $\sigma : A^\perp \otimes B$ and $\tau : B^\perp \otimes C$ is the strategy $\tau \circ \sigma : A^\perp \otimes C$ obtained by letting the strategies σ and τ react to a Player move in A or to an Opponent move in C , possibly after a series of internal exchanges in B .

A formal definition of identities and composition is also possible, but it requires to introduce a few notations. A play is called *legal* when it is alternating and when it starts by an Opponent move. The set of legal plays is denoted L_A . The set of legal plays of even-length is denoted L_A^{even} . Note that L_A^{even} may be defined alternatively as the set of legal plays ending by a Player move. The identity of the Conway game A is defined as the strategy below:

$$id_A = \{ s \in L_{A^\perp \otimes A}^{\text{even}} \mid \forall t \in L_{A^\perp \otimes A}^{\text{even}}, t \text{ is prefix of } s \Rightarrow t|_{A^\perp} = t|_A \}.$$

The composite of two strategies $\sigma : A^\perp \otimes B$ and $\tau : B^\perp \otimes C$ is the strategy of $\tau \circ \sigma : A^\perp \otimes C$ below:

$$\tau \circ \sigma = \{ s \in L_{A^\perp \otimes C}^{\text{even}} \mid \exists t \in P_{A \otimes B \otimes C}, t|_{A,B} \in \sigma, t|_{B,C} \in \tau, t|_{A,C} = s \}.$$

The tensor product between Conway games gives rise to a bifunctor on the category \mathbf{G} , which makes the category $*$ -autonomous, that is, symmetric monoidal closed, with a dualizing object noted \perp . See Chapter 4 for a definition of these notions. The category \mathbf{G} is more than just $*$ -autonomous: it is compact closed, in the sense that there exists two isomorphisms

$$1^\perp \cong 1 \qquad (A \otimes B)^\perp \cong A^\perp \otimes B^\perp \qquad (98)$$

natural in A and B , and satisfying the coherence diagrams of a monoidal natural transformation from $(\mathbf{G}, \otimes, 1)$ to its opposite category. The situation is even simpler in the particular case of Conway games, since the isomorphisms (98) are replaced in that case by identities. As in any compact closed category, the dualizing object \perp is isomorphic to the identity object of the monoidal structure, in that case the Conway game 1 . Thus, the monoidal closure $A^\perp \otimes \perp$ is isomorphic to A^\perp , for every Conway game A .

8.9 Conway games: a Lafont category

The category \mathbf{G} defines a $*$ -autonomous category, and thus a model of multiplicative linear logic. Unfortunately, it is not clear today that the original model may be extended to intuitionistic linear logic. In particular, it is still an open question whether there exists a free (or rather co-free) construction for commutative comonoids in the category \mathbf{G} of Conway game originally defined by André Joyal [54]. Intuitively, the free commutative comonoid $!A$ generated by a game A is a game where several copies of the game A may be played in parallel, each new copy being opened by Opponent. Since the number of copies is not bounded, it is not obvious to see how such a free commutative comonoid may be constructed in a setting where only *well-founded* games are allowed.

However, as we will see below, the free construction becomes available when one relaxes the well-foundedness hypothesis.

The category \mathbf{G}^∞ of Conway games

The category \mathbf{G}^∞ has (possibly non well-founded) Conway games as objects, and strategies of $A^\perp \otimes B$ as morphisms $A \rightarrow B$. Composition of strategies and identities are defined as in the original category \mathbf{G} of Conway games. Note that the composite of two winning strategies $\sigma : A \rightarrow B$ and $\tau : B \rightarrow C$ is not necessarily a winning strategy when the game B is not well-founded. Like the category \mathbf{G} , the category \mathbf{G}^∞ is $*$ -autonomous, and in fact compact-closed. As such, it defines a model of multiplicative linear logic, where the conjunction \otimes and the disjunction \wp are identified.

Free commutative comonoid

It appears that every Conway game A generates a free (or rather co-free) commutative comonoid $!A$ in the category \mathbf{G}^∞ . The game $!A$ is defined as follows:

- its positions are the finite lists (x_1, x_2, \dots, x_m) of positions x_1, \dots, x_m of the game A ,
- its moves from a position (x_1, x_2, \dots, x_m) to a position (y_1, y_2, \dots, y_n) are of two kinds:
 - a move $x_i \rightarrow y_i$ of the game A occurs in one of the copies $1 \leq i \leq m$, while the number of copies remains unchanged, and thus: $n = m$, and the position $x_j = y_j$ of the $m - 1$ other copies $j \neq i$ remain identical, this leading to a move:

$$(x_1, \dots, x_{i-1}, x_i, x_{i+1}, \dots, x_m) \rightarrow (x_1, \dots, x_{i-1}, y_i, x_{i+1}, \dots, x_m)$$

whose polarity in the game $!A$ is the same as the polarity of the move $x_i \rightarrow y_i$ in the game A ,

- an Opponent move $*_A \rightarrow y$ of the game A opens a new copy, and thus: $n = m + 1$ and $y_n = y$, while the position $x_j = y_j$ of the m other copies $1 \leq j \leq m$ remains identical, this leading to a move:

$$(x_1, \dots, x_m) \rightarrow (x_1, \dots, x_m, y)$$

whose polarity is Opponent in the game $!A$.

Obviously, the Conway game $!A$ is not well-founded as soon as the game A admits an initial move of polarity Opponent. This means that the Conway game $!A$ is an element of \mathbf{G}^∞ even when the game A is an element of \mathbf{We} leave as exercise to the reader the proof that

Exercise. Show that $!A$ defines indeed the co-free commutative comonoid generated by a Conway game A in the category \mathbf{G}^∞ . The exercise is far from easy: the interested reader will find a proof in joint article with Nicolas Tabareau [75].

■

8.10 Decomposition of the exponential modality

For the sake of illustration, we decompose the exponential modality $!$ of coherence spaces as a suspension modality S followed by a duplication modality D . From a logical point of view, the suspension modality S enables to apply the weakening rule (but not the contraction rule) on the modal formula SA whereas the duplication modality D enables to apply the contraction rule (but not the weakening rule) on the modal formula DA .

The suspension modality

The suspension modality S transports every coherence space A to the coherence space SA whose elements of the web are

- the singleton cliques $[a]$ containing exactly one element a of the web $|A|$,
- the empty clique of A , which we will note $*_A$ for this purpose.

The coherence relation of SA is defined as the coherence relation of A on the singleton cliques:

$$\forall a_1, a_2 \in |A|, \quad [a_1] \circ_{SA} [a_2] \iff a_1 \circ_A a_2$$

with the element $*_A$ coherent to all the elements of the web:

$$\forall a \in |A|, \quad *_A \circ_{SA} [a].$$

The duplication modality

The duplication modality D transports every coherence space $A = (|A|, \circ_A)$ to the coherence space DA

- whose elements of the web $|DA|$ are the finite and *nonempty* cliques of A ,
- where two elements $u, v \in |DA|$ of the web are coherent when their union (as cliques) is a clique of A .

The exponential modality of coherence spaces factors in the following way:

$$!_{\text{set}} = S \circ D.$$

The difficulty then is to understand what this decomposition really means. It is easy to see that the two modalities S and D define comonads, noted $(S, \delta^S, \varepsilon^S)$ and $(D, \delta^D, \varepsilon^D)$. But the composite $S \circ D$ of two comonads does not necessarily define a comonad: to that purpose, one needs a *distributivity law* in the sense of Jonathan Beck [10].

Distributivity laws

A *distributivity law* between two comonads S and D is defined as a natural transformation

$$\lambda : S \circ D \rightarrow D \circ S$$

making the four coherence diagrams below

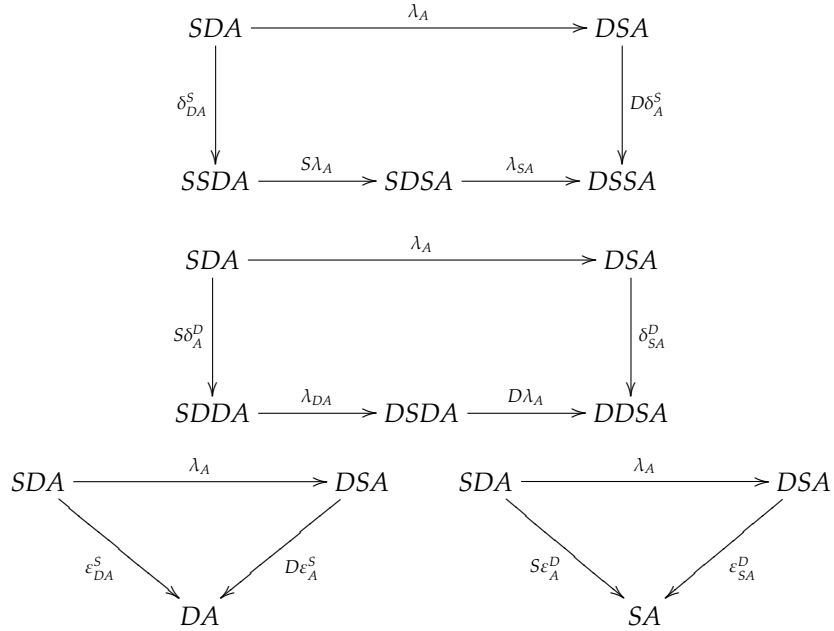

commute, for every coherence space A . This may be also expressed topologically, as equalities between string diagrams:

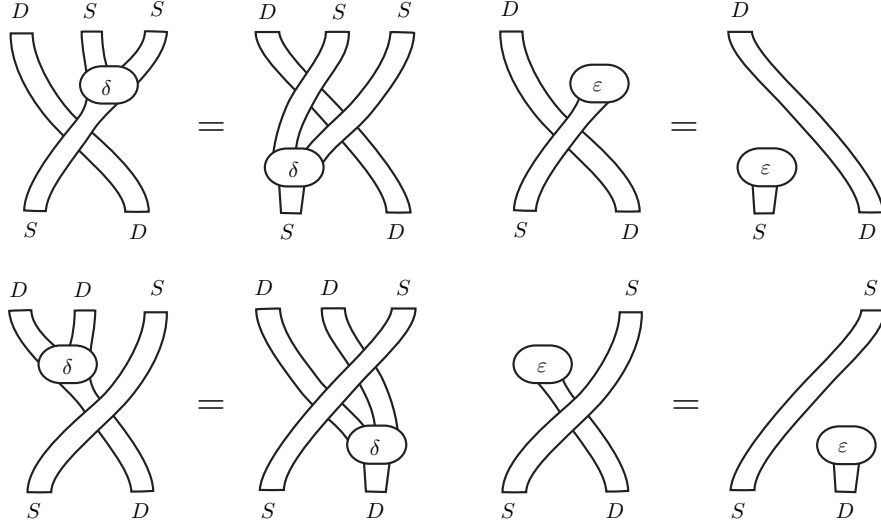

where the distributivity law λ is depicted as a braiding permuting the strings of the comonads S and D . It appears that such a distributivity law λ between the comonads S and D exists in the category \mathbf{COH} . Its component

$$\lambda_A : SDA \rightarrow DSA$$

is defined as the clique

$$\lambda_A := \left\{ \begin{array}{l} \{ *_{DA} \multimap [*_A] \} \\ \uplus \\ \{ [[a_1, \dots, a_k]] \multimap [[a_1], \dots, [a_k]] \mid a_1, \dots, a_k \in |A| \} \\ \uplus \\ \{ [[a_1, \dots, a_k]] \multimap [[a_1], \dots, [a_k], *_A] \mid a_1, \dots, a_k \in |A| \}. \end{array} \right.$$

for all coherence space A . There exists also a distributivity law

$$\bar{\lambda} : D \circ S \rightarrow S \circ D$$

whose component is defined as

$$\bar{\lambda}_A := \left\{ \begin{array}{l} \{ [*_A] \multimap *_{DA} \} \\ \uplus \\ \{ [[a_1], \dots, [a_k]] \multimap [[a_1, \dots, a_k]] \mid a_1, \dots, a_k \in |A| \}. \end{array} \right.$$

for all coherence space A . The existence of the two distributivity laws λ and $\bar{\lambda}$ implies that both $S \circ D$ and $D \circ S$ define comonads in the category \mathbf{COH} . This fundamental property of distributivity laws is established by purely equational means, and thus holds in any 2-category. This suggests to lift the situation,

and to replace the 2-category **Cat** where we are currently working, by the 2-category **SymMonCat** of symmetric monoidal categories, symmetric monoidal functors (in the lax sense) and monoidal natural transformation. The first step in this direction is to equip the two comonads S and D with coercion morphisms defined as

$$\begin{aligned}
m_{A,B}^S & : S(A) \otimes S(B) \longrightarrow S(A \otimes B) \\
m_{A,B}^S & := \begin{array}{c} \{ (*_A \otimes *_B) \multimap *_A \otimes *_B \} \\ \uplus \\ \{ ([a] \otimes [b]) \multimap [a \otimes b] \mid a \in |A|, b \in |B| \} \end{array} \\
m_1^S & : 1 \longrightarrow S(1) \quad := \quad \{ * \multimap *_1 \} \uplus \{ * \multimap [*] \}
\end{aligned}$$

and

$$\begin{aligned}
m_{A,B}^D & : D(A) \otimes D(B) \longrightarrow D(A \otimes B) \\
m_{A,B}^D & := \left\{ \begin{array}{c} [a_1, \dots, a_k] \otimes [b_1, \dots, b_k] \multimap [a_1 \otimes b_1, \dots, a_k \otimes b_k] \\ \text{where} \\ a_1, \dots, a_k \in |A| \text{ and } b_1, \dots, b_k \in |B|. \end{array} \right\} \\
m_1^D & : 1 \longrightarrow D(1) \quad := \quad \{ * \multimap [*] \}.
\end{aligned}$$

Once the two symmetric monoidal comonads S and D defined in this way, it appears that the distributivity laws λ and $\bar{\lambda}$ are monoidal natural transformations between $S \circ D$ and $D \circ S$. In other words, the distributivity laws λ and $\bar{\lambda}$ between the comonads S and D lift along the forgetful 2-functor

$$\mathbf{SymMonCat} \longrightarrow \mathbf{Cat}$$

which transports every symmetric monoidal category to its underlying category. This ensures that the two composite comonads $S \circ D$ and $D \circ S$ are symmetric and lax monoidal in the category $(\mathbf{COH}, \otimes, 1)$.

Exercise. Establish naturality and monoidality of λ and of $\bar{\lambda}$ and check that the four coherence diagrams of distributivity laws commute. [Hint: use the fact that all the structural morphisms $A \longrightarrow B$ are defined as functions from the web $|B|$ of the codomain to the web $|A|$ of the domain.] ■

The Eilenberg-Moore coalgebras of the suspension modality S

We give here a concrete description of the category \mathbf{COH}^S of Eilenberg-Moore coalgebras of the suspension modality S . Consider the category $(\mathbf{COH} \downarrow 1)$ whose objects are the pairs (A, h_A) consisting of a coherence space A and a morphism taken in the category \mathbf{COH}

$$h_A : A \longrightarrow 1$$

and whose morphisms between such pairs

$$f : (A, h_A) \longrightarrow (B, h_B)$$

are morphisms between the underlying coherence spaces

$$f : A \longrightarrow B$$

making the diagram

$$\begin{array}{ccc} A & \xrightarrow{f} & B \\ & \searrow h_A & \swarrow h_B \\ & 1 & \end{array}$$

commute in the category \mathbf{COH} . Equivalently, every pair (A, h_A) may be seen as a coherence space A equipped with an anticlique h_A . A morphism $f : (A, h_A) \longrightarrow (B, h_B)$ is then a morphism between coherence spaces which transports the anticlique h_B to the anticlique h_A by relational composition.

We have seen in Proposition 15 (Section 6.2) that the monoidal unit 1 defines a commutative monoid in any symmetric monoidal category, and consequently in the category \mathbf{COH} . From this follows that the category $(\mathbf{COH} \downarrow 1)$ is symmetric monoidal, with tensor product \otimes^S of two objects (A, h_A) and (B, h_B) defined as the coherence space $A \otimes B$ equipped with the morphism

$$A \otimes B \xrightarrow{h_A \otimes h_B} 1 \otimes 1 \xrightarrow{\lambda = \rho} 1.$$

This morphism may be seen equivalently as the tensor product of the two anticliques h_A and h_B . The forgetful functor

$$U : (\mathbf{COH} \downarrow 1) \longrightarrow \mathbf{COH}$$

which transports every pair (A, h_A) to its underlying coherence space A is symmetric and strictly monoidal. Moreover, it has a right adjoint

$$F : \mathbf{COH} \longrightarrow (\mathbf{COH} \downarrow 1)$$

which transports every coherence space A to the coherence space $A \& 1$ equipped with the second projection morphism

$$\pi_2 : A \& 1 \longrightarrow 1.$$

This object of $(\mathbf{COH} \downarrow 1)$ may be seen equivalently as the object $A \& 1$ equipped with the anticlique consisting the single element of the web of 1 . The adjunction $U \dashv F$ means that a morphism f making the diagram

$$\begin{array}{ccc} A & \xrightarrow{f} & B \& 1 \\ & \searrow h_A & \swarrow \pi_2 \\ & 1 & \end{array}$$

commute, is entirely described by its composite

$$A \xrightarrow{f} B\&1 \xrightarrow{\pi_1} B$$

with the first projection. The left adjoint functor U is strictly monoidal. By Proposition 5.17 (Section 5.17) the adjunction $U \dashv F$ is thus symmetric monoidal, in the lax sense. The resulting symmetric monoidal comonad is precisely the suspension comonad

$$S : A \mapsto A\&1.$$

The adjunction is comonadic, in the sense that the category $(\mathbf{COH} \downarrow 1)$ coincides with the category \mathbf{COH}^S of Eilenberg-Moore coalgebras of the comonad S , with U as (canonical) forgetful functor

$$U : \mathbf{COH}^S \longrightarrow \mathbf{COH}.$$

Besides, the monoidal structure of the category $(\mathbf{COH} \downarrow 1)$ coincides with the monoidal structure $(\otimes^S, 1)$ which equips the category \mathbf{COH}^S of Eilenberg-Moore categories defined in Section 6.10. In a nutshell: the adjunction $U \dashv F$ coincides with the canonical adjunction associated to the comonad S in the 2-category **SymMonCat** of symmetric and lax monoidal functors.

The Kleisli category associated to the suspension modality S

At this stage, it is wise to see the Kleisli category \mathbf{COH}_S as the full subcategory of \mathbf{COH}^S consisting of the free S -coalgebras. As a matter of fact, a *free* S -coalgebra is precisely a coherence space A equipped with a singleton anticlique

$$h_A : A \longrightarrow 1.$$

The main point to notice then is that the monoidal structure of the category \mathbf{COH}^S restricts to the category \mathbf{COH}_S . This follows from the fact that the tensor product of two singleton anticliques is a singleton anticlique. The resulting tensor product \otimes_S on the Kleisli category \mathbf{COH}_S does not coincide with the tensor product of \mathbf{COH} , in the sense that the canonical right adjoint functor

$$M_S : \mathbf{COH} \longrightarrow \mathbf{COH}_S$$

does not transport the tensor product of \mathbf{COH} to the tensor product of \mathbf{COH}_S inherited from the tensor product of \mathbf{COH}^S . On the other hand, the left adjoint functor

$$L_S : \mathbf{COH}_S \longrightarrow \mathbf{COH}$$

is symmetric and *strong* monoidal, this making the adjunction

$$\begin{array}{ccc} & L_S & \\ \mathbf{COH}_S & \xrightarrow{\quad} & \mathbf{COH} \\ & \perp & \\ & M_S & \end{array}$$

symmetric and lax monoidal.

Modal decomposition

Our next observation is that the comonad D lifts to a comonad D^S in the category \mathbf{COH}^S of Eilenberg-Moore S -coalgebras. The definition of the comonad D^S is very simple: it transports every S -coalgebra seen as a coherence space A equipped with an anticlique

$$h_A : A \longrightarrow 1$$

to the coherence space $D(A)$ equipped with the anticlique defined as follows:

$$D(A) \xrightarrow{Dh_A} D(1) \xrightarrow{\varepsilon^D} 1.$$

The careful reader will notice that the existence of the distributivity law $\bar{\lambda} : DS \rightarrow SD$ mentioned earlier in the section ensures that the comonad D lifts to a comonad on the category \mathbf{COH}^S , and that the resulting comonad coincides with D^S . Besides, the fact that the natural transformation $\bar{\lambda}$ is lax monoidal ensures that the comonad D^S is symmetric and lax monoidal in the category \mathbf{COH}^S with monoidal structure inherited from \mathbf{COH} .

A remarkable point is that the comonad D^S on \mathbf{COH}^S transports free S -coalgebras to free S -coalgebras, and thus restricts to a comonad D_S in the full subcategory \mathbf{COH}_S of free S -coalgebras. The resulting comonad D_S is symmetric and lax monoidal in the Kleisli category \mathbf{COH}_S equipped with the monoidal structure $(\otimes_S, 1)$ inherited from the category \mathbf{COH}^S . This leads to a decomposition of the original linear-non-linear adjunction

$$\begin{array}{ccc} & L & \\ \text{STABLE} & \xrightarrow{\quad} & \text{COH} \\ & \perp & \\ & M & \end{array}$$

between the category \mathbf{COH} of coherence spaces and linear functions, and the category \mathbf{STABLE} of qualitative domains and stable functions, into a pair of symmetric and lax monoidal adjunctions

$$\begin{array}{ccccc} & L_D & & L_S & \\ \text{STABLE} & \xrightarrow{\quad} & \text{AFFINE} & \xrightarrow{\quad} & \text{COH} \\ & \perp & & \perp & \\ & M_D & & M_S & \end{array}$$

where \mathbf{AFFINE} denotes the category of coherent qualitative domains and affine functions between them – a category which coincides with the Kleisli category \mathbf{COH}_S associated to the comonad S – see Section 8.10 for a definition of coherent qualitative domains.

9 Conclusion

One lesson of categorical semantics is that the exponential modality of linear logic should be described as an adjunction, rather than as a comonad. The observation is not simply technical: it has also a deep effect upon the way we understand logic in the wider sense. This establishes indeed that the decomposition of the intuitionistic implication performed in linear logic

$$A \Rightarrow B \quad := \quad (!A) \multimap B \quad (99)$$

may be carried on one step further, with a decomposition of the exponential modality itself, as

$$! \quad := \quad L \circ M. \quad (100)$$

Here, the task of the functor

$$M \quad : \quad \mathbb{L} \longrightarrow \mathbb{M}$$

is to multiply every "linear" object A into a "multiple" object MA of the category \mathbb{M} , while the task of the functor

$$L \quad : \quad \mathbb{M} \longrightarrow \mathbb{L}$$

is to linearize every "multiple" object A of the category \mathbb{M} to a "linear" object LA of the category \mathbb{L} . This refined decomposition requires to think differently about proofs, and to accept the idea that

logic is polychrome, not monochrome

this meaning that several universes of discourse (in this case, the categories \mathbb{L} and \mathbb{M}) generally coexist in logic, and that the purpose of a proof is precisely to intertwine these various universes by applying back and forth modalities (in this case, the functors L and M). In this account of logic, each universe of discourse implements its own body of internal laws. Typically, in the case of linear logic, the category \mathbb{M} is cartesian in order to interpret the structural rules (weakening and contraction) while the category \mathbb{L} is symmetric monoidal closed, or $*$ -autonomous, in order to interpret the logical rules. The chromatic reference comes from string diagrams, where each category \mathbb{L} and \mathbb{M} is represented by a specific color (\mathbb{L} in dark red, \mathbb{M} in light blue), each modality L and M defining "functorial boxes" enshrining these universes of discourse inside one another, like russian puppets. Typically, the diagram

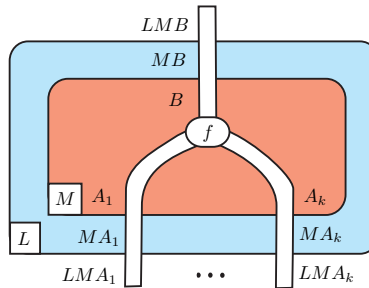

represents the morphism

$$f : A_1 \otimes \cdots \otimes A_k \longrightarrow B$$

living in the category \mathbb{L} , transported by the functor M to the category \mathbb{M} , and then transported back to the category \mathbb{L} by the functor L . See [73] for a detailed account of this diagrammatic notation of proofs.

Another useful lesson of categorical semantics is that

the structural rules of logic are generic

this meaning that the structure of the exponential modality does not depend on the underlying logic. This phenomenon is manifest in the central part of this survey (Chapter 7) which is devoted to the categorical structure of the exponential modality of linear logic. In this chapter, it appears that the various axiomatizations of the exponential modality only require that the category \mathbb{L} is symmetric monoidal, and in some cases, cartesian. In particular, these axiomatizations are independent of the hypothesis that the category \mathbb{L} is either monoidal closed, or *-autonomous. This basic observation leads to the notion of *resource modality* formulated in recent collaborative work with Nicolas Tabareau [75]. A resource modality on a symmetric monoidal category $(\mathbb{L}, \otimes, 1)$ is defined as a symmetric monoidal adjunction (in the lax sense)

$$\begin{array}{ccc} & L & \\ \mathbb{M} & \begin{array}{c} \curvearrowright \\ \perp \\ \curvearrowleft \end{array} & \mathbb{L} \\ & M & \end{array} \quad (101)$$

between the symmetric monoidal category $(\mathbb{L}, \otimes, 1)$ and a symmetric monoidal category $(\mathbb{M}, \boxtimes, u)$. The resource modality is called:

- *exponential* when the tensor product \boxtimes is a cartesian product and the tensor unit u is a terminal object in the category \mathbb{M} ,
- *affine* when the unit u is a terminal object in the category \mathbb{M} ,
- *relevant* when there exists a monoidal natural transformation

$$A \longrightarrow A \boxtimes A$$

satisfying the associativity and commutativity laws of a commutative (unit-free) comonoid.

We have seen earlier in this survey (Chapter 5) that a resource modality (101) is the same thing as an adjunction $L \dashv M$ in the usual sense, where the left adjoint functor L is equipped as a symmetric and strong monoidal functor (L, m) . Hence, a modular approach to linear logic enables to extract the appropriate notion of resource modality, and to apply it in situations – typically encountered in game semantics – where the category \mathbb{L} is symmetric monoidal, but not closed.

A third lesson of categorical semantics is that

resource modalities do compose

when one sees them as adjunctions, rather than as comonads. Indeed, in several important interpretations of logic, like coherence spaces or sequential games, we have observed (Chapter 8) that the exponential modality $L \dashv M$ of linear logic factors as an affine modality $L_S \dashv M_S$ followed by a relevant modality $L_D \dashv M_D$ in a situation depicted as follows:

$$\begin{array}{ccc}
 \mathbb{M} & \begin{array}{c} \xrightarrow{L_D} \\ \perp \\ \xleftarrow{M_D} \end{array} & \mathbb{P} & \begin{array}{c} \xrightarrow{L_S} \\ \perp \\ \xleftarrow{M_S} \end{array} & \mathbb{L}
 \end{array} \tag{102}$$

This pair of adjunctions induces a suspension comonad S living in the category \mathbb{L} and a duplication comonad D living in the category \mathbb{P} as follows:

$$S := L_S \circ M_S \qquad D := L_D \circ M_D.$$

In the case of coherence spaces as well as in the case of sequential games, one may define the categories \mathbb{P} and \mathbb{M} as the Kleisli categories

$$\mathbb{P} := \mathbb{L}_S \qquad \mathbb{M} := \mathbb{P}_D$$

associated to the comonad S and D , respectively. A generic argument establishes then that the category \mathbb{M} coincides necessarily with the Kleisli category $\mathbb{L}_!$ associated to the exponential comonad on the category \mathbb{L} .

It is worth mentioning that an additional structure occurs in the specific case of coherence spaces: there exists indeed a comonad (also noted D for this purpose) living in the category $\mathbb{L} = \mathbf{COH}$ of coherence spaces and linear maps, which extends along the embedding functor M_S as the comonad D of the category $\mathbb{P} = \mathbf{COH}_S$. This ability of the comonad D in \mathbf{COH} to extend along M_S is reflected by a distributivity law

$$\lambda : S \circ D \longrightarrow D \circ S$$

in the category \mathbf{COH} , which we have described earlier in this survey (Chapter 8). The existence of such a comonad D in the category \mathbf{COH} is specific to coherence spaces, and more generally, to the relational models of linear logic: in particular, there exists no such duplication comonad D in the category \mathbb{L} when one shifts to models of interaction based on sequential games.

This leads to the thesis that the decomposition of the exponential modality as an adjunction (102) is more generic and appropriate than its decomposition as a comonad (103) below:

$$! := S \circ D \tag{103}$$

since the exponential modality seen as an adjunction $L \dashv M$ factors in exactly the same way (102) in sequential games as in coherence spaces, see [75] for details. Besides, the decomposition formula (103) it conveys the false impression that

the correct recipe to transform a linear formula A into a multiple one $!A$ is to transform the formula A into a replicable formula DA and then to apply the suspension modality S , in order to obtain the desired formula $!A = SDA$.

The polychromatic decomposition (102) reveals that the correct order to proceed is rather the opposite one:

$$! := L_S \circ L_D \circ M_D \circ M_S. \quad (104)$$

The task of the first operation M_S is to transport the linear formula A into an affine formula $M_S(A)$ while the task of the second operation M_D is to transport the resulting affine formula to the multiple formula $M(A) = M_D M_S(A)$ living in the cartesian category \mathbb{M} . Here again, categorical semantics clarifies a misconception, induced by our prevalent monochromatic vision of logic.

Categorical semantics offers an essential tool in the fine-grained analysis of logic... leading to the decomposition of logical connectives and modalities into smaller meaningful components. This practice has been extremely fruitful in the past, and leads to the bold idea that there are such things as

elementary particles of logic

whose combined properties and interactions produce the logical phenomenon.

In this atomic vision of logic, proof theory becomes a linguistic laboratory, where one studies the logical connectives defined by tradition, and tries to decompose them as molecules of elementary particles – in the style of (99), (100) and (104). This quest is driven by the hypothesis that these basic particles of logic should be regulated by purely algebraic principles, capturing the essence of language and interactive behaviors. Seen from this angle, categorical semantics becomes the cornerstone of proof theory, extracting it gradually from its idiosyncratic language (sequent calculus, etc.) and offering a promising bridge with contemporary algebra.

An illustration of the atomic philosophy is provided by the algebraic study of negation, certainly one of the most basic ingredients of logic. In Chapter 4, we have introduced the notion of *dialogue category*, defined as a symmetric monoidal category $(\mathbb{C}, \otimes, 1)$ equipped with a *tensorial negation* – itself defined as a functor

$$\neg : \mathbb{C} \longrightarrow \mathbb{C}^{op}$$

equipped with a bijection

$$\psi_{A,B,C} : \mathbb{C}(A \otimes B, \neg C) \cong \mathbb{C}(A, \neg(B \otimes C))$$

natural in A , B and C , satisfying a coherence axiom discussed in Section 4.14. Every such tensorial negation induces an adjunction

$$\begin{array}{ccc} & L & \\ \mathbb{C} & \begin{array}{c} \curvearrowright \\ \perp \\ \curvearrowleft \end{array} & \mathbb{C}^{op} \\ & R & \end{array} \quad (105)$$

between the category \mathbb{C} and its opposite category \mathbb{C}^{op} , where R coincides with the functor \neg whereas the functor L is defined as the opposite functor \neg^{op} . Looking at the unit η and counit ε of the adjunction

$$\eta_A : A \longrightarrow R \circ L(A) \qquad \varepsilon_B : B \longrightarrow L \circ R(B)$$

in the language of string diagrams



enables to reformulate the two triangular laws of an adjunction (see Chapter 5) as topological deformations:

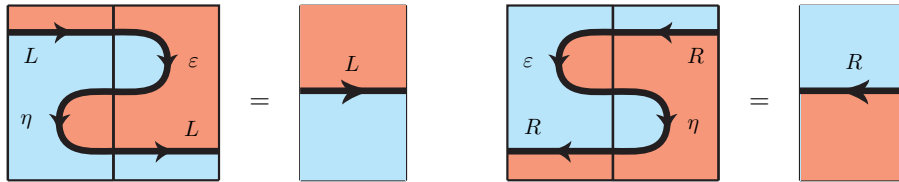

This diagrammatic point of view enables then to reconstruct game semantics from purely algebraic principles – where the trajectory of the functors R and L in the string diagram associated to a proof π reconstructs the interactive strategy $[\pi]$ induced by game semantics.

In this prospect, a typical proof is depicted as a natural transformation generated by the unit η and counit ε of the adjunction

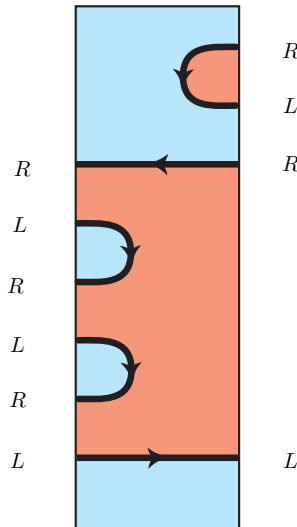

with cut-elimination identified as a purely topological procedure transporting, typically, the diagram

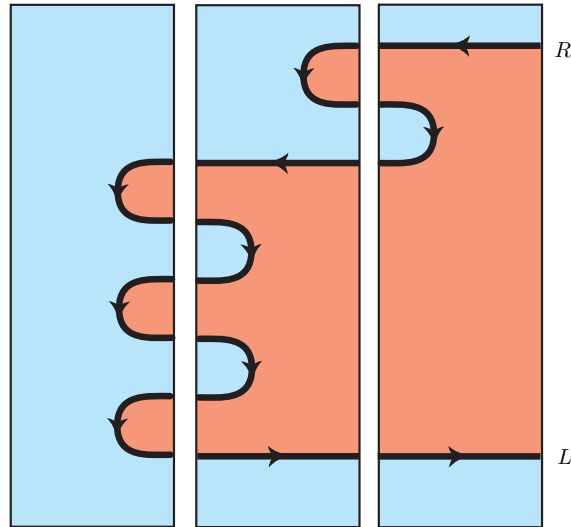

into the unit diagram η after a series of triangular laws. This dynamic and topological account of proofs supports the idea that there exists indeed such things as elementary particles of logic, whose properties remain to be clarified.

In this way, the notion of dialogue category provides an algebraic account of explicit models of interaction, based on games and strategies – rather than spaces and cliques – this offering precious insights on the abstract machines described by Pierre-Louis Curien, Hugo Herbelin and Jean-Louis Krivine in this volume.

We have already mentioned that the repetition modality of game semantics defines a resource modality (101) on the dialogue category \mathbf{C} . A notion of existential quantification may be also added to the logic: typically, the game interpreting the formula $\exists x.A(x)$ starts by a Proponent move which exhibits a witness x_0 for the variable x , and then carries on the game interpreting the formula A . Once translated in this logical framework, the drinker formula

$$\exists y.\{A(y) \Rightarrow \forall x.A(x)\}$$

mentioned in the introduction is (essentially) equivalent to the valid formula

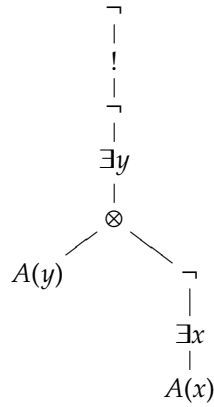

This formula implements a game where the repetition modality $!$ enables Proponent to backtrack at the position indicated by the modality, and thus, to change witness y in the course of interaction. In contrast, the translation of the drinker formula, understood this time in the intuitionistic sense, is (essentially) equivalent to the formula

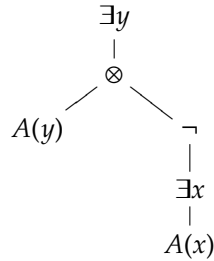

which does not allow repetition, and is thus not valid in the tensorial logic with existential quantification and repetition considered here. This leads to our last thesis, that

$$\mathbf{logic} = \mathbf{data\ structure} + \mathbf{duality}$$

where data structure are constructed using connectives like:

- \otimes tensor product,
- \exists existential quantification,
- $!$ repetition modality,

and where duality means logical negation

$$A \mapsto \neg A$$

whose purpose is to permute the roles of Proponent (proof, program) and Opponent (refutation, environment). Although schematic, the thesis clarifies in what

sense proof theory extends the traditional boundaries of computer science (the study of data structures and algorithms) by incorporating a new ingredient: logical duality. Duality is an essential aspect of programming languages: remember indeed that every program is designed to interact with other programs, defining its *continuation*. If the author is correct, this algebraic approach to negation should lead to a fruitful synthesis between linear logic and the general theory of computational effects. There is little doubt that categorical semantics will offer the most precious guide in this ongoing investigation.

We will conclude this survey by mentioning that, for purely independent reasons, the algebraic investigation of logical duality has become a central topic of contemporary algebra, with promising connections to quantum algebra and mathematical physics. Recall that a Frobenius algebra F is a monoid (F, m, e) and a comonoid (F, d, u) satisfying the following equalities

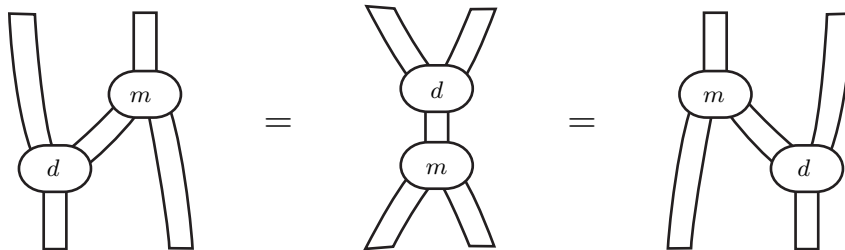

expressed here using string diagrams. The notion of Frobenius algebra captures the idea of a 2-dimensional cobordism in topological quantum field theory, see Joachim Kock's monograph [60] for a categorical introduction to the topic.

Now, Brian Day and Ross Street observed that a $*$ -autonomous category is the same thing as a relaxed 2-dimensional notion of Frobenius algebra, defined in a bicategory of (categorical) bimodules – sometimes called profunctors, or distributors, depending on the origin of the locutor – whose multiplication and unit are special bimodules induced by functors, see [30, 85]. Relaxing one step further this 2-dimensional notion of Frobenius algebra leads to the notion of dialogue category discussed above, with promising connections to game semantics.

Then, Day and Street define a *quantum category* on a field k as a monoidal comonad (in the lax sense) induced by a monoidal adjunction

$$\begin{array}{ccc}
 & f_* & \\
 E & \begin{array}{c} \curvearrowright \\ \perp \\ \curvearrowleft \end{array} & V^{op} \otimes V \\
 & f^* &
 \end{array}$$

This adjunction relates the object-of-edges E and the Frobenius monoid $V^{op} \otimes V$ induced by the (left and right) duality

$$V^{op} \dashv V \dashv V^{op}$$

between the object-of-vertices V of the quantum category, and its opposite V^{op} .

The idea is to mimic the basic situation of quantum algebra, where the notion of Hopf algebra in the category of vector spaces provides a “quantum” counterpart to the notion of group in the category of sets. Here, the monoidal adjunction $f_* \dashv f^*$ is supposed to live in a monoidal bicategory of comodules, providing a “quantum” counterpart to the bicategory of spans on sets – where such a monoidal adjunction $f_* \dashv f^*$ defines a category in the usual sense. Day and Street carry on, and define a *quantum groupoid* as a $*$ -autonomous quantum category – that is, a quantum category where, in addition, the object-of-edges E is $*$ -autonomous, as well as the adjunction $f_* \dashv f^*$ relating E to $V^{op} \otimes V$, all this defined in a suitable sense explicated in [30].

So, categorical semantics leads to an area of mathematics where the traditional frontiers between algebra, topology and logic gradually vanish, to reveal a unifying and harmonious piece of n -dimensional algebra. This emerging unity includes a series of basic dualities scattered in the literature:

- algebraic duality – defined by an antipode in a Hopf algebra,
- categorical duality – defined by a duality in a monoidal category,
- logical duality – defined by the negation of a formula,
- ludic duality – defined by the symmetry between Player and Opponent,
- programming duality – defined by the continuation of a program.

One fascinating aspect of this convergence is that a purely logical observation – the necessity to replace the involutive negation by a non involutive one, and to shift from $*$ -autonomous categories to dialogue categories, in order to reflect game semantics properly – becomes suddenly connected to questions of an algebraic nature, regarding the nature of antipodes and dualities in quantum groups. Today, much remains to be investigated in this largely unexplored area at the frontier of logic, algebra, and computer science.

Acknowledgments. This survey has been elaborated during a graduate course on linear logic and game semantics at the University Paris Diderot. The author is grateful to his friends and colleagues Antonio Bucciarelli, Juliusz Chroboczek, Vincent Danos, Thomas Ehrhard, Russ Harmer, Olivier Laurent and Giuseppe Longo for co-tutoring the course along the years, and to Emmanuel Beffara, Pierre Clairambault, Michel Hirschowitz, Joachim de Lataillade, François Mauriel, Samuel Mimram, Raphael Montelatici, Emmanuel Polonovski, Nicolas Tabareau and Christine Tasson (among many others) for taking part so actively in it. This survey would have never existed without them. The author is also indebted to Albert Burroni, Pierre-Louis Curien, Russ Harmer, Masahito Hasegawa, Martin Hyland and the anonymous referee for precious discussions and helpful comments on preliminary versions of this survey.

Paul-André Melliès
Laboratoire Preuves, Programmes, Systèmes
CNRS & Université Paris Diderot
75205 Paris Cedex 13, France
Email: mellies@pps.jussieu.fr

References

- [1] **Michele Abrusci and Paul Ruet.** Non-commutative logic I: the multiplicative fragment. *Annals of Pure and Applied Logic* 101(1): 29-64, 2000.
- [2] **Roberto Amadio and Pierre-Louis Curien.** *Domains and Lambda-Calculi*. Cambridge University Press, 1998.
- [3] **Jean-Marc Andreoli, Gabriele Pulcini, Paul Ruet.** Permutative Logic. *Proceedings of Computer Science Logic 2005*. Volume 3634 of Lecture Notes in Computer Science, Springer Verlag, 2005.
- [4] **Andrew Barber, Philippa Gardner, Masahito Hasegawa and Gordon Plotkin.** From action calculi to linear logic. *Proceedings of Computer Science Logic '97*, Aarhus, Denmark. Volume 1414 of Lecture Notes in Computer Science, Springer Verlag. 1997.
- [5] **Andrew Barber and Gordon Plotkin.** Dual intuitionistic linear logic. Technical Report, LFCS, University of Edinburgh, 1997.
- [6] **Andrew Barber.** *Linear Type Theories, Semantics and Action Calculi*. PhD Thesis of the University of Edinburgh. LFCS Technical Report CS-LFCS-97-371. 1997.
- [7] **Michael Barr.** *-autonomous categories and linear logic. *Mathematical Structures in Computer Science*. 1(2):159-178, 1991.
- [8] **Michael Barr.** Non-symmetric star-autonomous categories. *Theoretical Computer Science*, 139 (1995), pp 115 - 130.
- [9] **Nuno Barreiro and Thomas Ehrhard.** Quantitative semantics revisited. *Proceedings of the Typed Lambda-Calculi and Applications conference*, Lecture Notes in Computer Science, Springer Verlag, 1581, 40-53, 1999.
- [10] **Jon Beck** Distributive laws. *Lecture Notes in Mathematics* 80: 119-140, 1969.
- [11] **Jean Bénabou.** Introduction to bicategories. *Reports of the Midwest Category Seminar*. Volume 47 of Lecture Notes in Mathematics, Springer Verlag. 1967.
- [12] **Nick Benton, Gavin Bierman, Valeria de Paiva, Martin Hyland.** *Term assignment for intuitionistic linear logic*. Technical Report 262, Computer Laboratory, University of Cambridge, 1992.
- [13] **Nick Benton.** A Mixed Linear and Non-Linear Logic: Proofs, Terms and Models. *Proceedings of Computer Science Logic '94*, Kazimierz, Poland. Volume 933 of Lecture Notes in Computer Science, Springer Verlag. June 1995.

- [14] **Gérard Berry**. Stable models of typed lambda-calculi. Proceedings of the 5th International Colloquium on Automatas, Languages and Programming, number 62 in Lecture Notes in Computer Science. Springer Verlag 1978.
- [15] **Gavin Bierman**. On intuitionistic linear logic. *PhD Thesis*. University of Cambridge Computer Laboratory, December 1993.
- [16] **Gavin Bierman**. What is a categorical model of intuitionistic linear logic? *Proceedings of the Second International Conference on Typed Lambda Calculus and Applications*. Volume 902 of Lecture Notes in Computer Science, Springer Verlag. Edinburgh, Scotland, April 1995. Pages 73-93.
- [17] **Lars Birkedal, Rasmus Møgelberg and Rasmus Lerchedahl Petersen**. Category-theoretic models of Linear Abadi & Plotkin Logic. *Theory and Applications in Categories*, 20(7):116-151, 2008.
- [18] **Rick Blute**. Hopf Algebras and Linear Logic. *Mathematical Structures in Computer Science* 6, pp. 189-217, 1996.
- [19] **Rick Blute, Robin Cockett, Robert Seely, Todd Trimble**. Natural Deduction and Coherence for Weakly Distributive Categories. *Journal of Pure and Applied Algebra*, 113(1996)3, pp 229-296.
- [20] **Rick Blute and Phil Scott**. The Shuffle Hopf Algebra and Noncommutative Full Completeness. *Journal of Symbolic Logic* 63, pp. 1413-1435, (1998).
- [21] **Rick Blute and Phil Scott**. Category Theory for Linear Logicians. *Linear Logic in Computer Science*. Edited by T. Ehrhard, J-Y. Girard, P. Ruet and P. Scott. London Mathematical Society Lecture Notes Series, Volume 316, Cambridge University Press, 2004.
- [22] **Francis Borceux**. *Handbook of Categorical Algebra 2. Categories and Structures*. Volume 51 of the Encyclopedia of Mathematics and Its Applications. Cambridge University Press, 1994.
- [23] **Albert Burroni**. Récursivité graphique (1e partie) : Catégorie des fonctions récursives primitives formelles. Cahiers de topologie et géométrie différentielle catégoriques. XXVII,1 1986.
- [24] **Albert Burroni**. Higher dimensional word problem with application to equational logic. *Theoretical Computer Science* 115, 43-62, Elsevier 1993.
- [25] **Samuel Buss**. An introduction to Proof Theory. *Handbook of Proof Theory*, Edited by Samuel Buss. Volume 137 of Studies in Logic and the Foundations of Mathematics, North Holland, 1998.

- [26] **Robin Cockett, Robert Seely.** Linearly Distributive Categories. *Journal of Pure and Applied Algebra*, 114(1997)2, pp 133-173.
- [27] **Pierre-Louis Curien.** On the symmetry of sequentiality. In *Proceedings of Mathematical Foundations of Programming Semantics*, MFPS'93, LNCS 802, Springer Verlag, 1993.
- [28] **Pierre-Louis Curien, Gordon Plotkin, and Glynn Winskel.** Bidomains and linear logic. *Festschrift for Robin Milner*, MIT Press.
- [29] **Pierre-Louis Curien and Hugo Herbelin.** Abstract machines for dialogue games. This volume.
- [30] **Brian Day and Ross Street.** Quantum categories, star autonomy, and quantum groupoids. In Galois theory, Hopf algebras and semiabelian categories. Volume 43 of Fields Institute Communications, American Mathematical Society, Providence, RI, 2004, pp. 187–225.
- [31] **Thomas Ehrhard.** Hypercoherences: a strongly stable model of linear logic. In *Mathematical Structures in Computer Science*, 3:365-385, 1993.
- [32] **Marcelo Fiore, Gordon Plotkin, John Power.** Complete cuboidal sets in Axiomatic Domain Theory. In *Proceedings of Logic in Computer Science (LiCS' 97)*, pages 268-279. IEEE, Computer Society Press, 1997.
- [33] **Gottlob Frege.** Begriffsschrift, a formula language, modeled upon that of arithmetic, for pure thought (1879). An english translation appears in *From Frege to Gödel. A source book in Mathematical Logic, 1879—1931*. Edited by J. van Heijenoort. Harvard University Press, 1967.
- [34] **Philippa Gardner and Masahito Hasegawa.** Types and models for higher-order action calculi. In Proc. 3rd International Symposium on Theoretical Aspects of Computer Software (TACS'97), Sendai. Springer LNCS 1281, pages 583-603, September 1997.
- [35] **Gerhard Gentzen.** Investigations into logical deduction (1934). An english translation appears in *The Collected Papers of Gerhard Gentzen*. Edited by M. E. Szabo, North-Holland 1969.
- [36] **Gerhard Gentzen.** *The Collected Papers*. Edited by M. E. Szabo, North-Holland 1969.
- [37] **Jean-Yves Girard.** *Proof Theory and Logical Complexity*. Studies in Proof Theory, Bibliopolis, 1987.
- [38] **Jean-Yves Girard, Yves Lafont, Paul Taylor.** *Proofs and Types*. Cambridge University Press (Cambridge Tracts in Theoretical Computer Science, 7). First published 1989, reprinted with corrections 1990. The book is available online at <http://www.cs.man.ac.uk/~pt/stable/Proofs+Types.html>

- [39] **Jean-Yves Girard**. The system F of variable types fifteen years later. *Theoretical Computer Science*, 45, 1986.
- [40] **Jean-Yves Girard**. Linear logic. *Theoretical Computer Science*, 50: 1-102, 1987.
- [41] **Jean-Yves Girard**. Locus Solum. *Mathematical Structures in Computer Science* 11, pp. 301-506, 2001.
- [42] **Jean-Yves Girard**. Le Point Aveugle. Hermann, collection "Visions des Sciences". 2006.
- [43] **Kurt Gödel**. On formally undecidable propositions of Principia Mathematica and related systems I (1931). An english translation appears in *From Frege to Gödel. A source book in Mathematical Logic, 1879—1931*. Edited by J. van Heijenoort. Harvard University Press, 1967.
- [44] **Russ Harmer, Martin Hyland and Paul-André Melliès**, Categorical combinatorics for innocent strategies. *Proceedings of the 22nd Annual IEEE Symposium on Logic in Computer Science*, Wrocław, 2007.
- [45] **Masahito Hasegawa**, Classical Linear Logic of Implications. *Mathematical Structures in Computer Science*. 15(2):323-342, April 2005.
- [46] **David Hilbert**. On the infinite (1925). An english translation appears in *From Frege to Gödel. A source book in Mathematical Logic, 1879—1931*. Edited by J. van Heijenoort. Harvard University Press, 1967.
- [47] **Robin Houston**. Mathematics of games. Notes available on the author's web page. October 2004.
- [48] **Dominic Hughes**. Simple free star-autonomous categories and full coherence. Manuscript. Submitted.
- [49] **Martin Hyland and Luke Ong**. On Full Abstraction for PCF: I, II and III, *Information and Computation*, Vol. 163, 2, pp. 285–408, 2000. Notes circulated since 1994.
- [50] **Martin Hyland**. Game Semantics. In *Semantics and logics of computation*. A. Pitts and P. Dybjer editors. Publications of the Newton Institute, Cambridge University Press, 1997.
- [51] **Martin Hyland and Andrea Schalk**. Abstract Games for Linear Logic. Extended Abstract. In *Proceedings of CTCS '99*, Volume 29 of Electronic Notes in Theoretical Computer Science, 1999.
- [52] **Martin Hyland and Andrea Schalk**. Games on Graphs and Sequentially Realizable Functionals. Extended Abstract. In: *Proc. Logic in Computer Science 2002*, IEEE Computer Science Press, pp. 257–264.

- [53] **Martin Hyland and Andrea Schalk.** Glueing and Orthogonality for Models of Linear Logic. In *Theoretical Computer Science 294* (2003), pp. 183–231.
- [54] **André Joyal.** Remarques sur la théorie des jeux à deux personnes. *Gazette des Sciences Mathématiques du Québec*, volume 1, numbe 4, pages 46–52, 1977.
- [55] **André Joyal and Ross Street.** Braided Tensor Categories, *Advances in Mathematics* 102, 20–78, 1993.
- [56] **André Joyal and Ross Street.** The geometry of tensor calculus, I. *Advances in Mathematics* 88, 55–112, 1991.
- [57] **André Joyal, Ross Street and Dominic Verity.** Traced monoidal categories. *Math. Proc. Camb. Phil. Soc.* 119, 447–468, 1996.
- [58] **Daniel Kan.** Adjoint functors. *Transactions of the American Mathematical Society*, 87:294-329, 1958.
- [59] **Christian Kassel.** *Quantum Groups*. Graduate Texts in Mathematics 155, Springer Verlag, 1995.
- [60] **Joachim Kock.** *Frobenius algebras and 2D topological quantum field theories*. No. 59 of London Mathematical Society Student Texts, Cambridge University Press, 2003.
- [61] **Jean-Louis Krivine.** Realizability in classical logic. This volume of *Panoramas et Synthèses*.
- [62] **Stephen Lack.** Limits for lax morphisms. *Applied Categorical Structures*, 13(3):189-203, 2005.
- [63] **François Lamarche.** Sequentiality, games and linear logic. *Manuscript*, 1992.
- [64] **Joachim Lambek.** The mathematics of sentence structure. *American Mathematical Monthly*, 65 (3): 154–170, 1958.
- [65] **Joachim Lambek and Philip Scott.** Introduction to Higher Order Categorical Logic. Cambridge Studies in Advanced Mathematics Vol. 7. Cambridge University Press, 1986.
- [66] **Saunders Mac Lane.** Categories for the working mathematician. *Graduate Texts in Mathematics* 5. Springer Verlag 2nd edition, 1998.
- [67] **Maria Emilia Maietti, Paola Maneggia, Valeria de Paiva, Eike Ritter** Relating categorical semantics for intuitionistic linear logic. *Applied Categorical Structures*, volume 13(1):1–36, 2005.

- [68] **Paola Maneggia**. Models of linear polymorphism. PhD thesis, School of Computer Science, 2004.
- [69] **Paul-André Melliès**. Asynchronous games 2: the true concurrency of innocence. Special issue of Theoretical Computer Science: *Selected papers of CONCUR 2004*, edited by P. Gardner and N. Yoshida. Volume 358, Issue 2-3, August 2006.
- [70] **Paul-André Melliès**. Comparing hierarchies of types in models of linear logic. *Information and Computation*, Volume 189, Issue 2, Pages 202-234, March 2004.
- [71] **Paul-André Melliès**. A topological correctness criterion for non-commutative logic. *Linear Logic in Computer Science*. Edited by T. Ehrhard, J-Y. Girard, P. Ruet and P. Scott. London Mathematical Society Lecture Notes Series, Volume 316, Cambridge University Press, 2004.
- [72] **Paul-André Melliès**. Categorical models of linear logic revisited. Manuscript. Preliminary version of this survey.
- [73] **Paul-André Melliès**. Functorial boxes in string diagrams. *Proceedings of Computer Science Logic 2006*. LNCS 4207, Springer Verlag, 2006.
- [74] **Paul-André Melliès and Samuel Mimram**. Asynchronous games without alternation. Journal version of the extended abstract published in the proceeding of the International Conference on Concurrency Theory, CONCUR 2007.
- [75] **Paul-André Melliès and Nicolas Tabareau**. Resource modalities in game semantics. Journal version of the extended abstract published in the proceeding of the IEEE Symposium on Logic in Computer Science 2007.
- [76] **Peter Nidditch**. Peano and the recognition of Frege. *Mind* 72, 1963.
- [77] **Dusko Pavlovic**. Chu I : cofree equivalences, dualities and star-autonomous categories. *Mathematical Structures in Computer Science*, Volume 7, Issue 1, pp 49 – 73, February 1997.
- [78] **Jeff Polakow and Frank Pfenning**. Relating natural deduction and sequent calculus for intuitionistic non-commutative linear logic. *Proceedings of the 15th Conference on Mathematical Foundations of Programming Semantics*, New Orleans, Louisiana, April 1999. Edited by A. Scedrov and A. Jung. Electronic Notes in Theoretical Computer Science, Volume 20.
- [79] **Gordon D. Plotkin**. Type Theory and Recursion. Extended Abstract. In *Proceedings of Logic in Computer Science (LiCS' 93)*, page 374. IEEE, Computer Society Press, 1993.

- [80] **Bruno Poizat**. A Course in Model Theory. *Universitext*. Springer Verlag, 2004.
- [81] **Andrea Schalk**. What is a categorical model for linear logic? Notes available on the author's web page. October 2004.
- [82] **Robert Seely**. Linear logic, star-autonomous categories and cofree coalgebras. *Applications of categories in logic and computer science*, Contemporary Mathematics, 92, 1989.
- [83] **Raymond Smullyan**. What Is the Name of This Book? The Riddle of Dracula and Other Logical Puzzles. Pelican, 1978.
- [84] **Ross Street**. The formal theory of monads. *Journal of Pure and Applied Algebra*, 2:149-168, 1972.
- [85] **Ross Street**. Frobenius monads and pseudomonoids, *Journal of Mathematical Physics* 45(10). October 2004.
- [86] **Ross Street**. *Quantum Groups: A Path to Current Algebra*. Australian Mathematical Society Lecture Series (No. 19). Cambridge University Press, 2006.
- [87] **Paul Taylor**. Quantitative Domains, Groupoids and Linear Logic. *Category Theory and Computer Science 1989*. ed. David Pitt, Springer Lecture Notes in Computer Science 389 (1989) 155-181.
- [88] **Jean van Heijenoort**. Logic as calculus and logic as language *Synthese*, Volume 17, Number 1, january 1967.
- [89] **Glynn Winskel**. A linear metalanguage for concurrency. *Proceedings of Algebraic Methodology and Software Technology, AMAST '98*, 1998.
- [90] **David Yetter**. Quantales and (noncommutative) linear logic. *Journal of Symbolic Logic* 55 (1990), 41-64.

Index

- *-autonomous category, 74
- 2-category, 94
 - Cat**, 97
 - LaxMonCat**, 98
 - SymMonCat**, 98
 - SymOplaxMonCat**, 98
- Adjunction, 99
 - Definition in 2-categories, 100
 - Linear-non-linear, 141
 - Triangular identities, 103
- Algebra, 128
 - Algebra morphism, 128
- Braiding, 67
 - Eckmann-Hilton, 116
- Cartesian categories
 - Cartesian 2-categories, 98
 - Cartesian product, 34
 - Characterization, 119
- Category
 - of commutative comonoids, 124
 - Eilenberg-Moore category \mathbf{C}^K , 132
 - Eilenberg-Moore category \mathbf{C}^T , 128
 - Kleisli category of a comonad, 132
 - Kleisli category of a monad, 128
 - Kleisli category \mathbf{C}_T , 128
 - Lafont category, 144
 - Lafont-Seely category, 163
 - Linear category, 151
 - of coherence spaces, 171
 - of Conway games, 183
 - of monoids, 114
 - of qualitative domains and stable functions, 172
 - Seely category, 146
- Coalgebra, 132
 - Coalgebra morphism, 132
- Coherence spaces, 171
 - Cliques, 172
 - Lafont category, 178
 - Lafont-Seely category, 179
 - Linear-non-linear adjunction, 173
 - Qualitative modality, 177
 - Quantitative modality, 177
 - Seely category, 177
- Comonad, 126
 - Category of Eilenberg-Moore coalgebras, 132
 - Kleisli category \mathbf{C}_K , 132
 - Symmetric monoidal comonad, 134
- Comonoid, 118
 - Comonoid morphism, 118
- Conway games, 183
 - Exponential modality, 186
- Cut-elimination theorem, 11
 - Axiom vs. hypothesis, 45
 - Commuting conversion, 42
 - Exchange steps, 46
 - Principal conclusion vs. principal hypothesis, 47
 - Procedure, 14
 - Promotion vs. structural rules, 48
 - Secondary conclusion, 50
 - Secondary hypothesis, 53
 - The η -expansion steps, 44
- Derivation trees, 6, 9
- Exponentiable object, 79
- Formula, 4
 - Drinker Formula, 17
- Functor
 - Duality between lax and oplax functors, 107
 - Lax monoidal, 86
 - Oplax monoidal, 87
 - Symmetric lax monoidal, 90
 - Symmetric oplax monoidal, 90
- Linearly distributive categories, 74
 - Braiding, 78
 - Duality, 76
 - Symmetry, 79
- Logic

- Classical Logic, 10
- First-order Logic, 15
- Intuitionistic linear logic, 42
- Intuitionistic Logic, 14
- Linear Logic, 15
- Linear logic, 41
- Monad, 126
 - Algebra of a monad, 128
 - Category of Eilenberg-Moore algebras, 128
 - Kleisli category, 128
- Monoid, 113
 - Commutative monoid, 113
 - Eckmann-Hilton, 116
 - Monoid morphism, 113
- Monoidal adjunction, 107
 - Characterization, 109, 111
 - Symmetric, 107
- Monoidal category, 63
 - *-autonomous, 74
 - Biclosed, 71
 - Braided, 67
 - Closed, 70
 - Dialogue category, 79
 - Exponentiable object, 79
 - Symmetric and closed, 72
 - Symmetry, 70
 - Tensorial negation, 79
 - Tensorial pole, 79
- Natural transformation, 88
 - Monoidal between lax functors, 88
 - Monoidal between oplax functors, 89
- Proofs, 6, 9
- Qualitative domains, 171
 - Affine functions, 172
 - Coherent qualitative domains, 173
 - Linear functions, 172
 - Stable functions, 172
- Resource modality, 195
 - Affine, 195
 - Exponential, 195
 - Relevant, 195
- Rules of logic
 - Contraction, 7
 - Exchange, 7
 - Logical Rules, 7
 - Structural Rules, 7
 - Weakening, 6
- Sequent calculus, 4
 - Cut-elimination, 11
 - Derivation trees, 9
 - Formula, 4
 - Intuitionistic linear logic, 42
 - Linear logic, 41
 - Proofs, 9
 - Rules of logic, 6
 - Sequent, 5
 - Subformula Property, 12
- String diagrams, 67
 - Braiding, 67
 - Functorial boxes, 164
- Subformula Property, 12
- Tautologies, 5
- Tensorial negation, 79
- Tensorial pole, 79
- Truth values, 5

Contents

1	Proof theory: a short introduction	2
2	Semantics: proof invariants and categories	21
2.1	Proof invariants organize themselves as categories	21
2.2	A tensor product in linear logic	23
2.3	Proof invariants organize themselves as monoidal categories (1) .	25
2.4	Proof invariants organize themselves as monoidal categories (2) .	28
2.5	Proof invariants organize themselves as monoidal categories (3) .	29
2.6	Conversely, what is a categorical model of linear logic?	31
2.7	Proof invariants and free categories	37
2.8	Notes and references	39
3	Linear logic and its cut-elimination procedure	40
3.1	Classical linear logic	40
3.2	Intuitionistic linear logic	41
3.3	Cut-elimination in intuitionistic linear logic	42
3.4	Cut-elimination: commuting conversion cut vs. cut	42
3.4.1	Commuting conversion cut vs. cut (first case)	42
3.4.2	Commuting conversion cut vs. cut (second case)	43
3.5	Cut-elimination: the η -expansion steps	44
3.5.1	The tensor product	44
3.5.2	The linear implication	44
3.5.3	The tensor unit	45
3.5.4	The exponential modality	45
3.6	Cut-elimination: the axiom steps	45
3.6.1	Axiom steps	45
3.6.2	Conclusion vs. axiom	46
3.7	Cut-elimination: the exchange steps	46
3.7.1	Conclusion vs. exchange (the first case)	46
3.7.2	Conclusion vs. exchange (the second case)	46
3.8	Cut-elimination: principal formula vs. principal formula	47
3.8.1	The tensor product	47
3.8.2	The linear implication	48
3.8.3	The tensor unit	48
3.9	Cut-elimination: promotion vs. dereliction and structural rules .	48
3.9.1	Promotion vs. dereliction	49
3.9.2	Promotion vs. weakening	49
3.9.3	Promotion vs. contraction	50
3.10	Cut-elimination: secondary conclusion	50
3.10.1	Left introduction of the linear implication	51
3.10.2	A generic description of the structural rules: dereliction, weakening, contraction, exchange	51
3.10.3	Left introduction of the tensor (with low priority)	52
3.10.4	Left introduction of the tensor unit (with low priority) . . .	53

3.11	Cut-elimination: secondary hypothesis	53
3.11.1	Right introduction of the tensor (first case)	54
3.11.2	Right introduction of the tensor (second case)	54
3.11.3	Left introduction of the linear implication (first case)	54
3.11.4	Left introduction of the linear implication (second case)	55
3.11.5	Left introduction of the linear implication (third case)	55
3.11.6	A generic description of the structural rules: dereliction, weakening, contraction, exchange	55
3.11.7	Left introduction of the tensor (first case) (with low priority)	57
3.11.8	Left introduction of the tensor (second case) (with low priority)	58
3.11.9	Left introduction of the tensor unit (with low priority)	58
3.11.10	Right introduction of the linear implication (with low pri- ority)	59
3.12	Discussion	59
3.13	Cut-elimination for classical linear logic	61
4	Monoidal categories and duality	63
4.1	Monoidal categories	63
4.2	String diagrams	67
4.3	Braided monoidal categories	67
4.4	Symmetric monoidal categories	70
4.5	Monoidal closed categories	70
4.6	Monoidal biclosed categories	71
4.7	Symmetric monoidal closed categories	72
4.8	*-autonomous categories	74
4.9	Linearly distributive categories	74
4.10	Duality in linearly distributive categories	76
4.11	Braided linearly distributive categories	78
4.12	Symmetric linearly distributive categories	79
4.13	*-autonomous categories as linearly distributive categories	79
4.14	Dialogue categories	79
4.15	*-autonomous as dialogue categories	83
4.16	Notes and references	84
5	Adjunctions between monoidal categories	85
5.1	Lax monoidal functors	86
5.2	Oplax monoidal functors	87
5.3	Natural transformations	88
5.4	Monoidal natural transformations (between lax functors)	88
5.5	Monoidal natural transformations (between oplax functors)	89
5.6	Symmetric monoidal functors (lax and oplax)	90
5.7	Functorial boxes in string diagrams	90
5.8	The language of 2-categories	94
5.9	The 2-category of monoidal categories and lax functors	97
5.10	Adjunctions between functors	99

5.11	Adjunctions in the language of 2-categories	100
5.12	Another formulation: the triangular identities	103
5.13	A dual definition of adjunction	105
5.14	Monoidal adjunctions	107
5.15	A duality between lax and oplax monoidal functors	107
5.16	A characterization of monoidal adjunctions	109
5.17	Symmetric monoidal adjunctions	111
5.18	Notes and references	112
6	Monoids and monads	113
6.1	Monoids	113
6.2	The category of monoids	114
6.3	Comonoids	118
6.4	Cartesian categories among monoidal categories	119
6.5	The category of commutative comonoids	124
6.6	Monads and comonads	126
6.7	Monads and adjunctions	128
6.8	Comonads and adjunctions	132
6.9	Symmetric monoidal comonads	134
6.10	Symmetric monoidal comonads and adjunctions	135
6.11	A useful property of retractions between coalgebras	137
7	Categorical models of linear logic	141
7.1	The transmutation principle of linear logic	143
7.2	Lafont categories	144
7.3	Seely categories	146
7.4	Linear categories	151
7.5	Lafont-Seely categories	163
7.6	Soundness in string diagrams	164
7.7	Notes and references	168
8	Two models of interaction: spaces and games	171
8.1	Coherence spaces	171
8.2	Coherence spaces: a linear-non-linear adjunction	173
8.3	Coherence spaces: a Seely category	177
8.4	Quantitative coherence spaces: a Lafont category	177
8.5	Qualitative coherence spaces: a Lafont category	178
8.6	Coherence spaces: a Lafont-Seely category	179
8.7	The relational non-model	181
8.8	Conway games: a compact-closed category	183
8.9	Conway games: a Lafont category	186
8.10	Decomposition of the exponential modality	187
9	Conclusion	194